

# FAR TOOLS®

Catalogue Général - General Catalog

Osez  
réussir !



Osez réussir = Dare to succeed



Scie\_Side

Contacter Suivre ...

« Que ce soit en rénovation ou fabrication , Fartools facilite mon quotidien de créateur , avec des outils bien pensés et accessibles» « Whether in renovation or manufacturing, Fartools makes my daily life as a creator easier, with well-designed and accessible tools.»

Benjamin D.

2025  
fartools.com



**MPO Distribuce s.r.o.**

## Na spolupráci se těší:



**Eliška Mlýnková**  
Objednávky, Expedice  
+420 725 588 682  
obchod@mpo-distribuce.cz



**Ing. David Polnar**  
Obchod, Marketing  
+420 604 584 557



**Ing. Petr Magdálek**  
IT, Provoz, Obchod  
+420 774 543 567



**Ing. Vít Olbert**  
Obchod, Finance  
+420 605 151 942

## Jak objednávat?

Vyberte si ten  
nejpohodlnější způsob.



- 1) <https://b2b.mpo-distribuce.cz/>
- 2) [obchod@mpo-distribuce.cz](mailto:obchod@mpo-distribuce.cz)
- 3) +420 212 242 399
- 4) +421 911 200 090
- 5) FAX: ten už bohužel nemáme :-)



**Wolfcraft**

[www.wolfcraftcz.cz](http://www.wolfcraftcz.cz)



**Fartools**

[www.kartacove-brusky.cz](http://www.kartacove-brusky.cz)



**Ultragrime**

[www.ultragrime.cz](http://www.ultragrime.cz)



**Shoulder Dolly**

[www.shoulderdolly.cz](http://www.shoulderdolly.cz)



**Bruns**

[www.drzakynaradi.cz](http://www.drzakynaradi.cz)



**Peugeot**

[www.naradi-kvalitne.cz](http://www.naradi-kvalitne.cz)

<b>DÉCAPAGE - STRIPPING</b> .....	Page 09-26
Rénovateurs - <i>Renovators</i> .....	Page 12
Sablage - <i>Sandblasting</i> .....	Page 22
<b>ELECTROPORTATIF - HANDPOWER TOOLS</b> .....	Page 27-90
Perçage/Vissage - <i>Drilling</i> .....	Page 28
Meulage - <i>Grinding</i> .....	Page 42
Ponçage - <i>Sanding</i> .....	Page 51
Assemblage - <i>Joining</i> .....	Page 58
Moulurage - <i>Miling</i> .....	Page 60
Sciage - <i>Cuting</i> .....	Page 62
Loisirs créatifs - <i>DIY</i> .....	Page 73
Divers électro. - <i>Miscellaneous</i> .....	Page 83
<b>GAMME PLATEFORME 18V - 18V RANGE</b> .....	Page 91-120
X-Fit .....	Page 91-120
<b>ATELIER - WORKSHOP</b> .....	Page 121-136
Caisses de transport - <i>Storage boxes</i> .....	Page 122
Servantes - <i>Work stands</i> .....	Page 124
Etaux - <i>Vices</i> .....	Page 126
Supports de machine électro. - <i>Stands for machine</i> .....	Page 128
Levage - <i>Lifting materials</i> .....	Page 130
<b>STATIONNAIRE BOIS - WOOD MACHINES</b> .....	Page 137-154
Sciage - <i>Cuting</i> .....	Page 138
Ponçage/Rabotage - <i>Sanding/planing</i> .....	Page 145
Tournage - <i>Turning wood</i> .....	Page 147
Divers stationnaire - <i>Miscellaneous</i> .....	Page 151
<b>STATIONNAIRE MÉTAL - METAL MACHINES</b> .....	Page 155-174
Meulage - <i>Grinding</i> .....	Page 156
Affûtage - <i>Sharpening</i> .....	Page 162
Perçage - <i>Drilling</i> .....	Page 167
Consommables - <i>Consumables</i> .....	Page 173
<b>NETTOYAGE - CLEANING</b> .....	Page 175-186
Nettoyeuses/shampouineuses - <i>Cleaners/shampoos</i> .....	Page 176
Vide-cendres/braises - <i>Ash/embers emptyer</i> .....	Page 178
Aspirateurs de chantiers/ateliers - <i>Workshop vacuum cleaners</i> .....	Page 181
Aspirateurs à décolmatage - <i>Unclogging vacuum cleaners</i> .....	Page 183
<b>MÉTIERIS - BUILDING TRADES</b> .....	Page 187-282
Métrologie - <i>Metrology</i> .....	Page 187
Construction - <i>Building range</i> .....	Page 191
Plaquiste - <i>Plasterboard range</i> .....	Page 211
Carreleur - <i>Tiler's range</i> .....	Page 235
Plombier - <i>Plumber's range</i> .....	Page 259
Soudeur - <i>Welder's range</i> .....	Page 269
Parqueteur - <i>Flooring's range</i> .....	Page 277
<b>JARDIN - GARDEN</b> .....	Page 283-299
Scies à bûches - <i>Log saws</i> .....	Page 284
Fendeurs de bûche - <i>Log splitters</i> .....	Page 288
Broyeurs de végétaux - <i>Schredders</i> .....	Page 292
Trancheuse - <i>Power trencher</i> .....	Page 295
Tarière - <i>Power auger</i> .....	Page 296
Divers jardin - <i>Miscellaneous</i> .....	Page 297
<b>SPECIAL EXPORT</b> .....	Page 300-304



**INNOVATION**

Une idée à faire partager ?

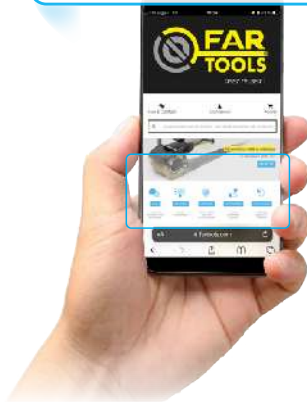

**DISTRIBUTEURS**

Localiser un distributeur à proximité



**ASSISTANCE**

Entrer en contact avec notre service après-vente



**CLIENT X-FIT/PRÉMIUM**

Profiter de la garantie X-FIT PREMIUM



**FAQ**

La réponse à votre question existe peut-être déjà !



Retrouvez-nous 24h/24

- Choix de produits
- Vidéos
- Contacts
- Photos Haute Définition
- Notices
- Vues éclatées
- Fiches techniques
- Fiches logistiques...



Un interlocuteur pour vous assister

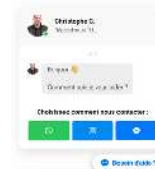

## Innovation Ouverte

### Atelier ouvert

- Un atelier de formation
- Un espace événementiel
- Un atelier de bricolage d'entreprise
- Un espace de création numérique



### Les Experts

Groupe de **professionnels** (artisans, auto-entrepreneurs) et grands bricoleurs qui apportent leur expertise afin de **développer des produits**.  
Ce processus **collaboratif** et commun conduit à **apporter des solutions concrètes** aux **besoins des consommateurs**.

LE CLUB DES



EXPERTS

### Des idées?

Une idée à faire partager ?  
Pensez à l'innovation ouverte !



# Une entreprise Engagée

## Label QUALI RÉPAR

FARTOOLS obtient le label quali répar :

Ce label est une aide à la réparation pour les particuliers financé par les éco-organismes.

Il répond aux nouvelles obligations de la loi anti-gaspillage pour une économie circulaire qui vise à promouvoir l'allongement de la durée d'usage des produits.



## 10 Ans de pièces

# AUTO RÉPARATION hors garantie

Munissez vous de :

La **référence** machine à 6 chiffres

Les 8 premiers chiffres du **numéro de série**

- Vue éclatée téléchargeable en ligne
- Prix et disponibilités en temps réel
- Achat en ligne

## Certification FSC®

FARTOOLS obtient la certification FSC® :

La certification de la chaîne de contrôle FSC® débute de la forêt jusqu'au revendeur. Cette certification témoigne de notre engagement envers la préservation de la biodiversité, la protection des habitats naturels et à la lutte contre la déforestation.



By buying this (product)  
you help take care of the  
world's forests

FSC® C190092 • [www.fsc.org](http://www.fsc.org)

## Services certifiés

FARGROUP obtient la certification Service France Garant® pour ses services Administration des ventes et SAV



BV Cert. 111486  
Service après-vente  
Prestations de service



 LinkedIn



 Youtube



 Facebook



 Instagram

## Restons en contact

Par email  
[fargroup@fargroup.net](mailto:fargroup@fargroup.net)

Par téléphone :  
+ 33 (0)2 47 46 56 56

Sur les réseaux sociaux :



Par Courrier :  
**FAR GROUP EUROPE**  
192, Avenue Yves Farge  
37700 Saint-Pierre-des-Corps  
**FRANCE**

Par Fax :  
+ 33 (0)2 47 46 56 50

# Nos engagements pour la planète

Depuis 2019, les équipes de **FARGROUP** et plus globalement celles des entreprises du **groupe SIGMA**, travaillent pied à pied, jour après jour, à la réduction de l'empreinte environnementale de notre activité.

Parce que le temps presse et que notre planète n'attend pas, nous nous concentrons sur **4 piliers essentiels** et prioritaires, qui couvrent toutes les étapes de vie du produit : de sa production jusqu'à sa fin de vie.



Chaque pilier est décliné en **ECO ACTIONS** dont la nature est, bien entendu, propre à chaque produit. Ainsi, par exemple, la carte perforée en plastique d'une clef de plombier sera remplacée par du carton recyclé et recyclable. Ou encore les lames de nos rainureuses ne seront prochainement plus livrées prémontées, afin de réduire le volume de transport.

Ces **ECO ACTIONS**, Fargroup les indiquera dorénavant et progressivement sur ses emballages, son site internet, ses fiches produits. C'est notre manière de nous engager devant vous et devant les utilisateurs de nos produits.

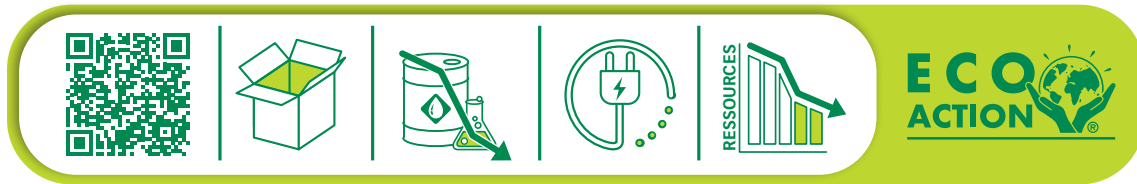

Réduire le volume des emballages

Diminuer l'usage d'hydrocarbure dans nos emballages

Pas de course à la puissance et ajuster les longueurs de câbles d'alimentation

Réduire l'appel aux ressources naturelles

## D'ores et déjà notre groupe a décidé de progressivement :

- ✓ Limiter l'emploi de **cerclages**, autour des suremballages, au strict nécessaire
- ✓ Migrer toutes les cartes en plastique vers des **cartes en carton rigide**
- ✓ Favoriser l'**auto-réparabilité** de nos produits en rendant disponible des pièces détachées et des tutoriels pédagogiques
- ✓ Utiliser des cartons **100 % recyclés & 100 % recyclables**
- ✓ Remplacer systématiquement l'utilisation d'encres minérales par des **encres végétales**
- ✓ Supprimer le **polystyrène** et les **films thermo-rétractables** de tous nos conditionnements
- ✓ Eliminer les **sachets en plastique** autour des manuels de sécurité et modes d'emploi

**Fargroup s'implique et s'engage concrètement pour préserver notre planète.**

Avec votre aide et celle de vos clients, nous pourrons **ensemble et positivement**, modifier nos usages et participer à ce défi **collectif** qui nous concerne tous.

# NOS ENGAGEMENTS

## Diminution packaging

## ECO ACTIONS

Retravailler le conditionnement a permis de supprimer des emballages les calages dérivés d'hydrocarbures, au profit d'un packaging **100 % recyclable**.

Notre action sur ce produit à permis :

- Un emballage **100 % recyclable**



Le retrait des mallettes plastiques au profit d'un sac de transport en tissu permet de **réduire** le volume d'emballage afin d'optimiser le transport.

Notre action sur ce produit à permis :

- **-49 %\*** de volume d'emballage



Sur l'ensemble de la gamme existante, le retrait de mallettes permet de réduire de **33 tonnes** le volume de plastique mis sur le marché par an.

\* Valeur comparative avec 2020 : année de référence

# NOS ENGAGEMENTS

## Migration des cartes

Le remplacement de nos cartes brochables en plastique au profit de cartes en carton compact permettront de **réduire** la quantité de plastique mis sur le marché de **2,2 t** et de diminuer ainsi notre impact environnemental.

Nos actions sur ce produit vont permettre :

- 50 000 cartes **100 %\*** recyclables par an, à terme.
- **-2,2 tonnes \*** de plastique par an, pour les cartes, à terme.



\* Valeur comparative avec 2020 : année de référence

# Outils de communication et d'aide à la vente

Les outils de communication et d'aide à la vente permettent une visibilité accrue dans les magasins, en mettant en valeur les caractéristiques principales des produits, les produits eux-mêmes et en optimisant l'espace disponible.

Vous trouverez ainsi :

- Gondoles
- Totems thématiques
- Stop rayon IL
- Écrans avec plus de 50 vidéos disponibles
- Cross market
- Master distributeur
- 1/2 palette et 1/4 palette
- Présentoir concept décapage
- Présentoir rotatif broches
- Support brise béton avec ILV
- Support jardin sans fil X-FIT avec ILV
- Support tarière
- Hélice holographique
- etc...

Quelques exemples :

Renseignez-vous auprès du commercial de votre secteur



Écrans avec plus de 50 vidéos disponibles



Présentoir brise béton avec ILV  
Ref. 140056

Présentoir de la trancheuse électrique avec ILV



Hélice holographique  
Ref. 140068 (voir p.88)



Support tarière et vis avec ILV  
Ref. 140055



Totem thématique 4 cubes  
Ref. 140317



# Garanties

## Nos garanties évoluent !

La garantie commerciale de nos produits Fartools varie **entre 1 et 5 ans** selon la catégorie du produit, à partir de la date d'achat indiquée sur votre ticket de caisse ou facture.

Un pictogramme sur l'emballage de la machine indique immédiatement la durée de garantie de votre machine :

**1 AN**  
GARANTIE

**2 ANS**  
GARANTIE

**3 ANS**  
GARANTIE

**5 ANS** **10 ANS**  
GARANTIE / RÉPARABILITÉ

### Garantie 1 an :

- Batteries X-FIT

### Garantie 2 ans :

- Gamme jardin
- Gamme Fartools ONE

### Garantie 3 ans :

- Outillage électroportatif filaire et non filaire
- Aspirateurs

### Garantie 5 ans :

- Gamme stationnaire bois et métal, avec prolongation de la garantie **jusqu'à 10 ans** pour les pièces détachées

**3 ANS**  
GARANTIE



# Nouvelles procédures SAV

**NOUVEAU**

## Un traitement des garanties SAV Fartools simplifié !

Finis le traitement papier ! Le mécanisme se digitalise grâce à un QR-Code qui pré-remplit votre demande de prise en charge par e-mail.

Un gain de temps pour vous, pour votre client et un geste pour la planète.

Suivez la procédure **«Fast Pass»** et ne perdez plus de temps avec un envoi papier !

- Scannez le QRcode
- Suivez les instructions (informations de la machine, coordonnées, etc...)
- Cliquez sur envoyer et c'est fini !





## Un Groupe dédié aux Fans

Le groupe **MyREXFartools** a pour vocation l'aide au choix des rénovateurs et de leurs brosses parmi l'offre décapage Fartools. En effet de nombreuses questions sont régulièrement posées sur l'usage du rénovateur et de ses différentes brosses. Le groupe a été créé pour répondre de façon adaptée à chaque situation et chaque demande.

Un volet en bois fragile à décaper, mais vous ne savez pas quelle brosse adapter ? Une multitude de vieilles couches de peinture sur un mur à ôter et vous voudriez savoir si une brosse dure avec une vitesse élevée pourra faire le travail ? La communauté est là pour vous aiguiller et vous conseiller.

N'hésitez plus et rejoignez-nous dans la communauté Facebook du décapage avec notre gamme de rénovateurs **Fartools** !

Des milliers de membres



## Comment choisir ?

Un outil à disposition

Le NOUVEAU site web [fartools.com](http://fartools.com) dispose désormais d'un outil d'aide au choix des brosses de rénovateur REX120.

Il suffira à l'utilisateur de quelques minutes pour être orienté vers la meilleure sélection de brosses pour son projet:

- 1- Choisir le type de support, bois, métal ou matériaux
- 2- Identifier parmi les exemples celui qui se rapproche de son projet (terrasse, portail, meuble...)
- 3- Affiner sa recherche en répondant à quelques questions (dureté du support, résultat escompté...)

L'outil suggère les modèles de brosses conseillées pour réaliser son projet, depuis l'ébauche jusqu'à la finition.

Ce guide de choix aide l'utilisateur final par des conseils d'utilisation et le rassure dans son acte d'achat et son désir d'entreprendre par lui-même.

**Oser réussir avec FARTOOLS !**

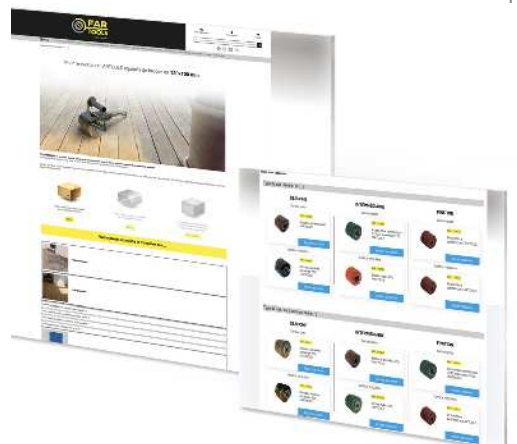

# L'univers décapage

Stripping

RÉNOVER - DÉCAPER - PONCER - SABLER

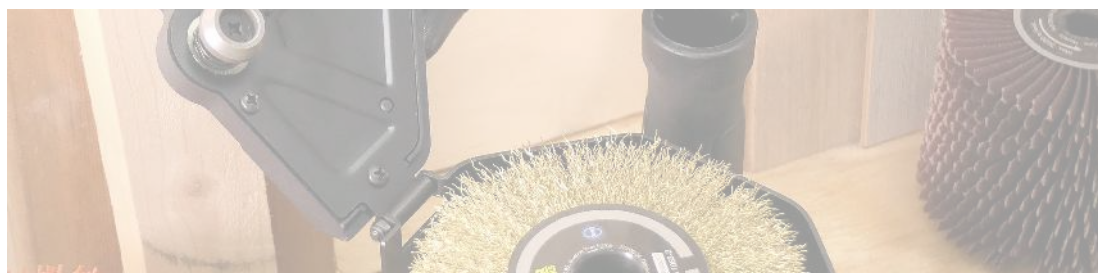

DÉCAPAGE  
STRIPPING

ÉLECTROPORTATIF  
HANDPOWER TOOLS

X-FIT  
RANGE

ATELIER  
WORKSHOP

BOIS  
WOOD MACHINES

MÉTAL  
METAL MACHINES

NETTOYAGE  
CLEANING

MÉTIER  
MANUAL WORK

JARDIN FILAIRE  
GARDEN TOOLS

Plus d'info sur  
[fartools.com](http://fartools.com)



## La catégorie **décapage**

c'est la solution gagnante pour vos linéaires  
Efficacité, rentabilité et satisfaction client



# Le rénovateur Fartools : une expertise de plus de 10 ANS !



Segmentation claire de l'offre produits par gradation croissante du REX 60 au REX-200.

Signalétique par des **frontons** pour renforcer l'**image de marque**.

Présentoir de brosses pré-monté adaptable sur gondole ou sur barre de force pour une **implantation rapide**.  
Existe en 1m et 1,25m



**Expérience sensorielle** des brosses pour choisir les usages.

ILV avec visuels de projets pour un maximum d'inspirations côté consommateur.



**Ecran avec vidéo** pour une aide à la vente en continu.



**Repérage par numérotation** pour correspondance entre les packagings des brosses et l'ILV :

**Stimulation des ventes.**



Les **produits complémentaires** tels que perche, sac...

DÉCAPAGE  
STRIPPING

ÉLECTROPORATIF  
HANDPOWER TOOLS

X-FIT  
RANGE

ATELIER  
WORKSHOP

BOIS  
WOOD MACHINES

MÉTAL  
METAL MACHINES

NETTOYAGE  
CLEANING

MÉTIER  
MANUAL WORK

JARDIN FILAIRE  
GARDEN TOOLS

Plus d'info sur  
**fartools.com**

# Rénovateur extérieur - Exterior renovator - REX 120D

120 x 100 mm

1300 Watts

Moyennes surfaces

**PRODUIT MALIN**  
SMART PRODUCT

SAC DE TRANSPORT  
TRANSPORTATION NYLON BAG



3431541109209

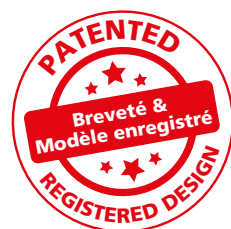

Changement rapide de brosse  
Quick brush change



- ▶ **INNOVATION** : Changement rapide de brosse  
INNOVATIVE: Quick brush change
- ▶ Ouverture du carter de protection sans outils, avec collecteur de poussières  
Opening the protective housing without tools, with dust collector
- ▶ Poignée rigide, ergonomique et orientable droitier/gaucher  
Rigid, ergonomic handle adapted to right or left hand user
- ▶ Variateur électronique de vitesse  
Electronic speed variator
- ▶ Interrupteur bloquant  
Locking switch

Livré avec une brosse laitonnée 0,3 mm et carter de protection  
Delivered with a 0.3 mm brass brush and guard



RUBBER  
Grip



SPEED  
Control



DUST  
Collector



Rénovateur extérieur - Exterior renovator	REX 120D
Gencode	3431541150270
Puissance du moteur - Motor power (230V-50Hz)	1300 W
Variateur de vitesse électronique - Electronic variable speed	900 - 3200 min <sup>-1</sup>
Dimensions de la brosse - Brush sizes	120 x 100 mm Max
Données logistiques - Logistic informations	
Box 120x220x480 mm   Master 4 x 5,25 kg   Pal 72   Ctr 20ft 1800 pcs	
Consommables - Consumables	
Voir page suivante - See next page	
Sac (p 14) - Bag (p 14)	3431541109209

# Broches pour rénovateur - Renovator brushes

120 x 100 mm



100 x ø 120 mm - Différentes broches = différents usages - REX 120C, REX 120D, REX 200 & REX-H 200  
Different brushes = different uses - REX 120C, REX 120D, REX 200 & REX-H 200



3431541108677



Lustrer - Faire briller  
Polish



3431541108738

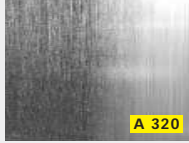

Satiner  
Polish



3431541108899



Nettoyer - dégraisser  
Cleaning

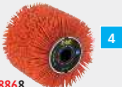

3431541108868



Nettoyer - Dégraisser  
Cleaning

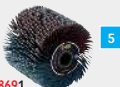

3431541108691



Poncer surfaces incurvées  
Sanding curved surfaces



3431541108884



Poncer surfaces planes  
Sanding flat surfaces

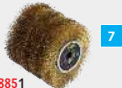

3431541108851



Dégriser - Décapage léger  
Deck stripper - Light stripping



3431541108745



Décapage fort  
Strong stripping



3431541108882



Décapier  
Stripping

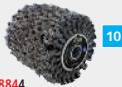

3431541108844



Creuser - décapage fort  
Grinding - Strong stripping



3431541108639



Poncer - satiner  
Polish



3431541108646



Finition surface plane  
Finishing flat surface

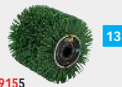

3431541109155



Nettoyer - Dégraisser  
Cleaning



3431541109162



Poncer surfaces incurvées  
Sanding curved surfaces



3431541109179



Poncer surfaces planes  
Sanding flat surfaces



20 x ø 120 mm - Différentes broches = différents usages  
SPECIAL REX 120C et REX 120D  
Different brushes = different uses  
SPECIAL REX 120C & REX 120D

Livré avec :  
Delivered with:

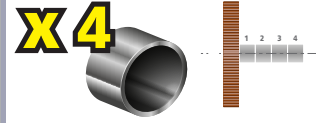

3431541108974



A 80

Poncer petites surfaces interstices  
Sand down small surfaces interstices



3431541108981

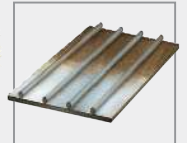

Décapage fort  
Stripping strong



3431541108998



A 80

Nettoyer - Dégraisser  
Clean - Foul up



3431541108653



Nettoyer - Dégraisser  
Clean - Foul up

DÉCAPAGE  
STRIPPING

ÉLECTROPORTEUR  
HANDPOWER TOOLS

X-FIT  
RANGE

ATELIER  
WORKSHOP

BOIS  
WOOD MACHINES

MÉTAL  
METAL MACHINES

NETTOYAGE  
CLEANING

MÉTIER  
MANUAL WORK

JARDIN FILAIRE  
GARDEN TOOLS

Plus d'info sur  
fartools.com

# Sac de transport - *Transportation bag* - MY REX BAG

24 L

Spécial rénovateur REX 120 | 115027



- ▶ **Compartiments amovibles pour rangement de 6 brosses**  
Removable compartments for 6 brushes storage

- ▶ **Poche intérieure**  
Inside pocket
- ▶ **Fond renforcé**  
Reinforced bottom
- ▶ **Poignées et bandoulière de transport**  
Carrying handles and strap

*Livré sans machine ni brosses*  
Delivered without machine nor brushes

YouTube



Sac de transport - *Transportation bag*

MY REX BAG

Gencode

3431541109209

Contenance - *Capacity*

24 L

Nombre de compartiments amovibles - *Quantity of compartments*

x 6

Dimensions - *Sizes*

L540xH200xP230 mm

Données logistiques - *Logistic informations*



Box 560x250x60 mm | Master 8x1,3 kg | Pal 192 | Ctr 20ft 3200 pcs



# Perche pliante - Foldable pole - REX-STAND

1250 mm

Compatible rénovateurs REX 120



- ▶ **Idéal pour travaux de sol en position debout**  
Recommended for floor work with stand up using
- ▶ **Perche pliante (700 mm) + support pour machine :**  
facile à transporter et stocker  
Foldable pole (700 m) + machine stand:  
Easy to transport and store
- ▶ **Interrupteur bloquant déporté**  
Remote locking switch trigger
- ▶ **Poignée orientable**  
Swivel handle
- ▶ **Range câble**  
Cable storage

Livrée avec flexible de 2 m et 2 connecteurs, (sans brosse ni machine)  
Delivered with 2 m hose and 2 connectors, (without brush nor machine)



**RUBBER**  
Grip



**DUST**  
Collector

Perche pliante - Foldable pole	REX-STAND
Gencode	<b>3431541109186</b>
Longueurs de la perche - Pole lengths	<b>1250 mm</b>
Interrupteur bloquant - Locking switch	<b>OK</b>
Diamètre des connecteurs - Connectors diameter	<b>ø 38 mm</b>
Données logistiques - Logistic informations	



3 431541 109186

Box 700x250x250 mm | Master 1x1,2 kg | Pal 80 | Ctr 20ft 700 pcs

DÉCAPAGE  
STRIPPING

ÉLECTROPORTATIF  
HANDPOWER TOOLS

X-FIT  
RANGE

ATELIER  
WORKSHOP

BOIS  
WOOD MACHINES

MÉTAL  
METAL MACHINES

NETTOYAGE  
CLEANING

MÉTIERS  
MANUAL WORK

JARDIN FILAIRE  
GARDEN TOOLS

Plus d'info sur  
**fartools.com**

# Rénovateur extérieur - Exterior renovator - REX 200

120 x 200 mm

1800 Watts

Grandes surfaces



- ▶ **Spécial grandes surfaces - gain de temps**  
For large surfaces - time saving
- ▶ **Largeur de décapage 200 mm = spécial grandes surfaces**  
Pickling width 200 mm = special large surfaces
- ▶ **Carter de protection avec collecteur de poussières**  
Protective housing with dust collector
- ▶ **Variateur de vitesse électronique**  
Electronic variable speed
- ▶ **Poignée rigide et ergonomique**  
Rigid and ergonomic handle

*Livré avec deux brosses laitonnées 0,3 mm largeur 100 mm et carter de protection*  
Delivered with two 0.3 mm brass brush width 100 mm and guard



**RUBBER**  
Grip



**SPEED**  
Control



**DUST**  
Collector

Rénovateur extérieur - Exterior renovator	REX 200
Gencode	3431541150157
Puissance du moteur - Motor power (230V-50Hz)	1800 W
Variateur de vitesse électronique - Electronic variable speed	900 - 3000 min <sup>-1</sup>
Dimensions de la brosse - Brush sizes	120 x 200 mm Max
Données logistiques - Logistic informations	
3 431541 1150157   Box 540x350x220 mm   Master 1 x 9,85 kg   Pal 28   Ctr 20ft 2100 pcs	
Consommables - Consumables	
Voir page 13 - See page 13	

# Rénovateur extérieur - Exterior renovator - REX-H 200

120 x 200 mm

1800 Watts

Travaux de sol grandes surfaces



- ▶ **Perche télescopique + support de machine** : travail en position debout  
Telescopic boom + machine stand: working in a standing position
- ▶ **Ideal pour travaux de sol**  
Recommended for floor work
- ▶ **Carter de protection avec collecteur de poussières**  
Protective housing with dust collector
- ▶ **Variateur de vitesse électronique**  
Electronic variable speed

Livré avec deux brosses laitonées 0,3 mm largeur 100 mm et carter de protection  
Delivered with two 0.3 mm brass brush width 100 mm and guard



**RUBBER**  
Grip



**SPEED**  
Control



**DUST**  
Collector

Rénovateur extérieur - Exterior renovator	REX-H 200
Gencode	3431541150195
Puissance du moteur - Motor power (230V~50Hz)	1800 W
Variateur de vitesse électronique - Electronic variable speed	900 - 3000 min <sup>-1</sup>
Dimension du patin - Pad sizes	ø 125 mm
Dimensions de la brosse - Brush sizes	120 x 200 mm Max
Données logistiques - Logistic informations	
Box 840x400x235 mm   Master 1 x 12,80 kg   Pal 14   Ctr 20ft 1000 pcs	
Consommables - Consumables	
Voir page 13 - See page 13	

DÉCAPAGE  
STRIPPING

ÉLECTROPORTATIF  
HANDPOWER TOOLS

X-FIT  
RANGE

ATELIER  
WORKSHOP

BOIS  
WOOD MACHINES

MÉTAL  
METAL MACHINES

NETTOYAGE  
CLEANING

MÉTIERS  
MANUAL WORK

JARDIN FILAIRE  
GARDEN TOOLS

Plus d'info sur  
**fartools.com**

# Rénovateur extérieur - Exterior renovator - REX 80

80 x 100 mm

420 Watts

Toutes surfaces et tous matériaux



«Machine très efficace, facile à prendre en main.»













Damien M.



EXISTE AUSSI EN VERSION ONE  
ALSO AVAILABLE IN ONE VERSION



Consommables - Consumables

 <b>A</b> 3431541108912	 <b>B</b> 3431541108929	 <b>C</b> 3431541108936	 <b>D</b> 3431541108943	 <b>E</b> 3431541109100	 <b>F</b> 3431541109117
 Dégriser - Décapage léger Deck stripper - Light stripping	 Nettoyer - Décrasser Cleaning	 Poncer surfaces planes Sanding flat surfaces	 Satiser - Lustrer Polish	 Lustrer - Faire briller Polish	 Métal rouillé Rusted metal



- ▶ **Changement de brosse rapide et sans outils**  
Quick keyless brush replacement
- ▶ **Compact et léger : 2,7 kg**  
Light & compact : 2,7 kg
- ▶ **Variateur de vitesse**  
Variable speed
- ▶ **Buse d'aspiration des poussières ø 32/35/42 mm ergonomique**  
Ergonomic dust collector ø 32/35/42 mm
- ▶ **Interrupteur blocable pour un plus grand confort d'utilisation**  
Lockable switch for better comfort

Livré avec brosse à lamelles  
Delivered with abrasive stripes brush



**RUBBER Grip**



**SPEED Control**



**DUST Collector**

**YouTube**



Rénovateur compact - Compact renovator	<b>REX 80</b>
Gencode	<b>3431541150188</b>
Puissance du moteur - Motor power (230V-50Hz)	<b>420 W</b>
Variateur de vitesse électronique - Electronic variable speed	<b>1000 - 3200 min<sup>-1</sup></b>
Dimension du disque - Disc sizes	<b>80 x 100 mm Max</b>

Données logistiques - Logistic informations



Box 120x220x480 mm | Master 4 x 5,25 kg | Pal 80 | Ctr 20ft 2036 pcs

# Rénovateur de précision - Precision renovator - REX 60

60 x 60 mm

300 Watts

Petites surfaces



Consommables - Consumables



3431541108776 180 : 3431541108837



Surface planes  
Flat surfaces



3431541108783



Surfaces courbes  
Curved surfaces



3431541108752



Petites surfaces  
Small surfaces



3431541108769 3431541108875



Petites surfaces  
métalliques  
Small metal surfaces

EXISTE AUSSI EN VERSION BATTERIE  
ALSO AVAILABLE IN BATTERY VERSION



XF-Brush - 216020 - P106



- ▶ **Carte de protection avec collecteur de poussières**  
Protective housing with dust collector
- ▶ **Poignée rigide et ergonomique**  
Rigid and ergonomic handle
- ▶ **Variateur électronique de vitesse**  
Electronic speed variator



Livré en sac tissu avec une roue, trois manchons et carte de protection  
Delivered in fabric bag with one wheel, three sleeves and protective casing



**RUBBER**  
Grip



**SPEED**  
Control



**DUST**  
Collector

Rénovateur de précision - Precision renovator

REX 60

Gencode **3431541150218**

Puissance du moteur - Motor power (230V~50Hz)

**300 W**

Variateur de vitesse électronique - Electronic variable speed

**1600 - 3000 min<sup>-1</sup>**

Dimensions de la brosse - Brush sizes

**60 x 60 mm Max**

Données logistiques - Logistic informations



3 431541 150218

Box 140x250x450 mm | Master 5x3,50 kg | Pal 115 | Ctr 20ft 1700 pcs

DÉCAPAGE  
STRIPPING

ÉLECTROPORATIF  
HANDPOWER TOOLS

X-FIT  
RANGE

ATELIER  
WORKSHOP

BOIS  
WOOD MACHINES

MÉTAL  
METAL MACHINES

NETTOYAGE  
CLEANING

MÉTIERS  
MANUAL WORK

JARDIN FILAIRE  
GARDEN TOOLS

Plus d'info sur  
**fartools.com**

# Ponceuse multi-têtes - Multihead sander - MULTI-REX 900

Ø 125 mm  
900 Watts

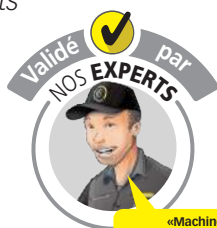

«Machine polyvalente & puissante avec un réglage de vitesse très utile.»  
Lionel L.



## 6 EN 1 6 TÊTES INTERCHANGEABLES 1 SEULE MACHINE



PLÂTRE  
PLASTER

MÉTAL  
METAL

BOIS  
WOOD



- ▶ Multifonctions & multimatériaux  
Multifunctions & multimaterials
- ▶ Poignée ajustable et ergonomique, 3 positions  
Adjustable and ergonomic handle, 3 positions
- ▶ Variateur de vitesse électronique  
Electronic variable speed
- ▶ Connectable à un aspirateur à décolmatage  
Connectable to a unclogging vacuum cleaner



Livrée avec un disque abrasif à lamelles et carter de protection  
Supplied with an abrasive flap disc and protective casing

\* Têtes vendues séparément - Heads sold separately

Ponceuse disqueuse MULTI-TÊTES - MULTIHEAD sander	MULTI-REX 900
Gencode	3431541150553
Puissance du moteur - Motor power (230V-50Hz)	900 W
Variateur de vitesse électronique - Electronic variable speed	1300 - 4000 min <sup>-1</sup>
Dimension du disque (ponçage - meulage) - Disc size (sanding - grinding)	Ø 125 mm
Dimension du disque (polissage - lustrage) - Disc size (polishing - finishing)	Ø 150 mm
Dimensions de la brosse - Brush sizes	Ø 80 x 100 mm
Dimensions de la bande (ponceuse lime) Belt sizes (filer)	533 x 9 mm 533 x 30 mm
Dimensions de la bande (ponceuse tube) - Belt sizes (Tube sander)	533 x 30 mm
Données logistiques - Logistic informations	

Box 320x160x400 mm | Master 4 x 2,3 kg | Pal 44 | Ctr 20ft 3970 pcs

Consommables - Consumables	
6 bandes Abrasives A40-A80-A120 533 x 30 mm - Abrasives belts	3431541159389
6 bandes Abrasives A40-A80-A120 533 x 9 mm - Abrasives belts	3431541159396
Disque béton Ø 125 mm - Concrete disc Ø125 mm	3431541158894
6 Disques abrasifs Ø 125 mm - Concrete disc Ø125 mm	3431541159174



### MULTIREX 900

- Puissance 900 W
- ø 125 mm
- Avec *variateur* de vitesse



## Composez votre outil de décapage MULTI-REX 900 jusqu'à 6 FONCTIONS:

- Economique, moindre coût
- Moins de ressources naturelles utilisées

*Osez réussir!*

#### ► PONCEUSE À LAMELLES

Déjà  
fourni  
avec votre  
Multirex



#### MULTIREX 900



3431541150553

DÉCAPAGE  
STRIPPING

#### ► PONCEUSE À TUBES



Option  
fonction

A80  
x 2

#### MR 900-TS



3431541150591

ÉLECTROPORATIF  
HANDPOWER TOOLS

X-FIT  
RANGE

#### ► RÉNOVATEUR



Option  
fonction

#### MR 900-REX



3431541150584

ATELIER  
WORKSHOP

BOIS  
WOOD MACHINES

#### ► PONCEUSE EXCENTRIQUE POLISSEUSE



Option  
fonction

#### MR 900-SP



3431541150577

MÉTAL  
METAL MACHINES

NETTOYAGE  
CLEANING

#### ► PONCEUSE LIME



Option  
fonction

A100  
x 2

A100  
x 2

#### MR 900-EFH



3431541150607

MÉTAL  
METAL MACHINES

MÉTAL  
METAL MACHINES

#### ► PONCEUSE PLÂTRE



Option  
fonction



A80  
x 3

#### MR-900-SH



3431541150621

JARDIN FILAIRE  
GARDEN TOOLS

Plus d'info sur  
**fartools.com**

# L'essentiel du SABLAGE

Le **sablage** et l'**aérogommage**, sont des techniques de **décapage** et de **nettoyage** qui utilisent de l'air comprimé pour projeter de l'abrasif sur une surface. Ces abrasifs sont propulsés à haute vitesse sur la surface à traiter. Le sablage est efficace pour éliminer la peinture, la rouille, le vernis, les traces de pollution ou les dépôts tenaces sans endommager le support d'origine. Cette technique est utilisée sur **différents matériaux** tels que le **bois**, le **métal** ou encore les **matières minérales** (pierre, brique, marbre, etc...)

Il faut trouver le bon équilibre entre la pression d'air comprimé, le débit d'écoulement de l'abrasif et le diamètre de buse choisi.  
Plus le **diamètre** de la buse est important, plus la **granulométrie** de l'abrasif pourra être importante. Les abrasifs les plus fins permettent d'obtenir un état de surface satiné.



## LE COMPRESSEUR :

Il est recommandé d'utiliser un compresseur équipé d'une cuve de **200 litres** et capable de délivrer au moins **250L/min** avec un moteur monophasé de 3cv. La pression de travail lors du sablage ne devra pas dépasser les **3 à 4 bars**.

## Les machines :

Sableuse aérogommeuse mobile  
**17 Litres**



### Les +

- Mobile pour intervention sur chantier
- Pour des pièces plus volumineuses.

### Les -

- Pas de recyclage d'abrasif
- Cantonnement du chantier

Cabine de sablage  
**90 Litres**



### Les +

- Travailler en circuit fermé
- Travail à l'intérieur
- Recyclage de l'abrasif

### Les -

- Contraint par la taille de la cabine

Cabine de sablage sur pieds  
**220 Litres**



### Les +

- Travailler en circuit fermé
- Travail à l'intérieur
- Travail à hauteur d'homme
- Recyclage de l'abrasif

### Les -

- Contraint par la taille de la cabine

## Les abrasifs disponibles\* :

\* Plusieurs granulométries d'abrasif sont disponibles à la vente en fonction de la surface à traiter et du résultat souhaité.

Référence	Intitulé	Composition	Granulométrie	Dureté	Couleur	Poids	Utilisation	Stockage
115113	RUGOS 2000	<b>Matériaux naturels ou minéraux</b>	100 à 630 microns	7 Mohs	Noir	25 kg	Nettoyage de surfaces métalliques, décapage de bois, préparation de surface	Endroit sec et bien ventilé
115114	Archifine n°5	<b>Silicate d'alumine</b> , Sans silice cristalline ni métaux	75 à 180 microns	6 Mohs	Bronze		Décapage standard dans le bâtiment, carrosserie, nautisme, préparation avant peinture	
115115	Archifine n°7	<b>Silicate d'alumine</b> , Sans silice cristalline ni métaux	30 à 150 microns	6 Mohs	Bronze		Travaux minitieux sur bois, aluminium, préparation avant microbillage	



Il est essentiel que l'abrasif soit bien sec pour obtenir une projection continue et assurer un fonctionnement optimum.

## Les équipements de protection individuelle (EPI) :

Lors de l'utilisation, il est impératif de porter des **équipements de protection individuelle (EPI)** : gants, masque et bouchons d'oreilles. Un masque à cartouches **P3** est conseillé pour protéger les voies respiratoires.







Livrée avec 4 buses céramique  
Delivered with 4 ceramic nozzles



Idéal pour gros travaux de sablage  
Ideal for big sandblasting work



Idéal projets de restauration  
Ideal for restoration projects

- ▶ Pour retirer la peinture, la rouille sur des gros volumes  
To remove paint and rust on large volumes
- ▶ **Doit être couplé à un compresseur d'une capacité de 100 à 250 l/min minimum**  
**Must be coupled with a compressor with a capacity of at least 100 to 250 liters/min**
- ▶ **Idéal pour projets de restauration ou décapage de pièces automobile**  
**Ideal for restoration projects or stripping of automobile parts**
- ▶ **Facile à transporter grâce à son chariot**  
**Easy to transport thanks to its trolley**
- ▶ **Longueur du tuyau de sablage : 2,5 mètres**  
**sandblast hose length : 2,5 meters**

Livrée avec tuyau et manomètre 4 buses céramique ø 2 / 2,5 / 3 / 3,5 mm  
Delivered with hose and manometer 4 ceramic nozzles ø 2 / 2,5 / 3 / 3,5 mm

Cuve de sablage - Mobile sandblaster	<b>CS 17</b>
Gencode	<b>3431541151000</b>
Volume de la cuve - tank capacity	<b>17 L</b>
Longueur du tuyau - Hose length	<b>2,5 m</b>
Pression de travail conseillée - Working pressure	<b>3/4 bars</b>
Capacité minimum du compresseur (non fourni) Minimum capacity of compressos (not delivered)	<b>100 L - 3 CV 250 l/min</b>
Poids - weight	<b>18 kg</b>

Données logistiques - Logistic informations

3 431541 151000 Box 730x420x360 mm | Master 1 x 18,0 kg | Pal 7 | Ctr 20ft 320 pcs

Consommables - Consumables

Abratif noir, 0,1 - 0,63 mm pour métal - 25 kg	<b>3431541151130</b>
Abratif Bronze n°5 pour bois - 25 kg	<b>3431541151147</b>
Abratif Bronze n°7 pour maquettiste - 25 kg	<b>3431541151154</b>
4 buses céramique ø 2 / 2,5 / 3 / 3,5 mm	<b>3431541151093</b>

# Cabine de sablage - Sandblaster cabinet - CS 90

90 Litres

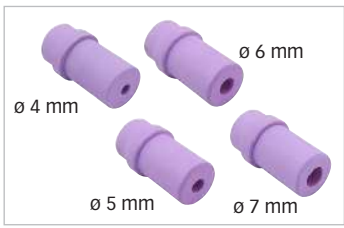

Livrée avec 4 buses céramique  
Delivered with 4 cermaic nozzles



Gants de protection en plastique lourd  
Heavy plastic protective gloves



Idéal projets de restauration  
Ideal for restoration projects

- ▶ Pour retirer la peinture, la rouille sur petites et moyennes pièces  
To remove paint and rust on small and medium parts
- ▶ Livrée avec 4 buses céramique ø 4 / 5 / 6 / 7 mm  
Delivered with 4 ceramic nozzles ø 4 / 5 / 6 / 7 mm
- ▶ Idéal pour projets de restauration ou décapage de pièces bois et métal  
Ideal for restoration projects or stripping of wood and metal parts
- ▶ Eclairage LED  
LED lighting
- ▶ Capacité de la table de travail : 20 kg maxi  
Capacity of the work table: 20 kg maximum
- ▶ Filtre intérieur  
Internal filter
- ▶ Hublot en verre 380 x 390 mm avec film de protection  
Glass porthole 380 x 390 mm with protective film

Livrée avec films de protection et pistolet de sablage  
Delivered with protective films and sandblasting gun

Cabine de sablage- Sandblaster cabinet	CS 90
Gencode	3431541151017
Volume de la cabine - Cabinet volume	90 L
Capacité de la table de travail - Work table capacity	20 kg
Pression de travail conseillée - Working pressure	3/4 bars
Capacité minimum du compresseur (non fourni) Minimum capacity of compressos (not delivered)	100 L - 3 CV 250 l/min
Poids - weight	18 kg

Données logistiques - Logistic informations

Box 620x530x220 mm | Master 1 x 19,3 kg | Pal 6 | Ctr 20ft 380 pcs  
3 431541 1151017

Consommables - Consumables

Abrasif noir, 0,1 - 0,63 mm pour métal - 25 kg	3431541151130
Abrasif Bronze n°5 pour bois - 25 kg	3431541151147
Abrasif Bronze n°7 pour maquettiste - 25 kg	3431541151154
Films protection hublot cabine de sablage 90 litres (x5)	3431541151109
Set de 4 buses en ceramique 4 / 5 / 6 / 7 mm	3431541151116

# Cabine de sablage - Sandblaster cabinet - CS 220

220 Litres

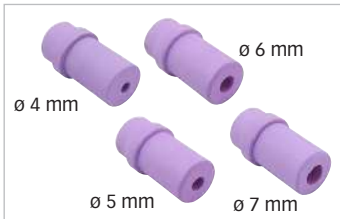

Livrée avec 4 buses céramique  
Delivered with 4 cermaic nozzles



Gants de protection en plastique lourd  
Heavy plastic protective gloves



Idéal projets de restauration  
Ideal for restoration projects

- ▶ Pour retirer la peinture, la rouille sur petites et moyennes pièces  
To remove paint and rust on small and medium parts
- ▶ Livrée avec 4 buses céramique ø 4 / 5 / 6 / 7 mm  
Delivered with 4 ceramic nozzles ø 4 / 5 / 6 / 7 mm
- ▶ Idéal pour projets de restauration ou décapage de pièces bois et métal  
Ideal for restoration projects or stripping of wood and metal parts
- ▶ Eclairage LED  
LED lighting
- ▶ Capacité de la table de travail : 20 kg maxi  
Capacity of the work table: 20 kg maximum
- ▶ Filtre intérieur  
Internal filter
- ▶ Hublot en verre 520 x 250 mm avec film de protection  
Glass porthole 520 x 250 mm with protective film

Livrée avec films de protection et pistolet de sablage  
Delivered with protective films and sandblasting gun

Cabine de sablage- Sandblaster cabinet	CS 220
Gencode	3431541151024
Volume de la cabine - Cabinet volume	220 L
Capacité de la table de travail - Work table capacity	20 kg
Pression de travail conseillée - Working pressure	3/4 bars
Capacité minimum du compresseur (non fourni) Minimum capacity of compressos (not delivered)	100 L - 3 CV 250 l/min
Poids - weight	47 kg

### Données logistiques - Logistic informations



Box 895x730x125 mm | Master 1 x 50 kg | Pal 4 | Ctr 20ft 216 pcs

### Consommables - Consumables

Abrasif noir, 0,1 - 0,63 mm pour métal - 25 kg	3431541151130
Abrasif Bronze n°5 pour bois - 25 kg	3431541151147
Abrasif Bronze n°7 pour maquettiste - 25 kg	3431541151154
Films protection hublot cabine de sablage 220 litres (x5)	3431541151123
Set de 4 buses en ceramique 4 / 5 / 6 / 7 mm	3431541151116

DÉCAPAGE  
STRIPPING

ÉLECTROPORATIF  
HANDPOWER TOOLS

X-FIT  
RANGE

ATELIER  
WORKSHOP

BOIS  
WOOD MACHINES

MÉTAL  
METAL MACHINES

NETTOYAGE  
CLEANING

MÉTIER  
MANUAL WORK

JARDIN FLAIRE  
GARDEN TOOLS

Plus d'info sur  
fartools.com

L'univers

Hand power tools

# Electroportatif

PERCER - VISSER - COUPER - MEULER - PONCER



DÉCAPAGE  
STRIPPING

ÉLECTROPORTATIF  
HANDPOWER TOOLS

X-FIT  
RANGE

ATELIER  
WORKSHOP

BOIS  
WOOD MACHINES

MÉTAL  
METAL MACHINES

NETTOYAGE  
CLEANING

MÉTIER  
MANUAL WORK

JARDIN FILAIRE  
GARDEN TOOLS

Plus d'info sur  
[fartools.com](http://fartools.com)

5 N/m  
3,6 V



- ▶ **Très léger**  
Very light
- ▶ **LED d'éclairage pour un confort visuel en milieu obscur**  
LED Lighting for a better work in dark areas
- ▶ **Vissage-dévisage**  
Screw-unscrew
- ▶ **Indicateur de charge**  
Charge indicators
- ▶ **2 positions et lampe torche LED**  
2 positions & LED flashlight
- ▶ **15 réglages de couple**  
15 torque settings



Livré en mallette avec accessoires  
Delivered with accessories



LED d'éclairage  
LED Lighting



**REVERSE**  
Réversible



**LED**  
Light



**RUBBER**  
Grip

Tournevis électrique Lithium-ion - Li-Ion screwdriver

**TS 36LB**

Gencode

**3431542152174**

Tension et puissance de la batterie - Battery voltage and power

**3,6 V - 1,5 Ah**

Temps de charge indicatif - Indicative charge time

**3 H**

Vitesse de rotation - Rotation speed

**210 tr.min<sup>-1</sup>**

Force - Power

**5 N/m**

Données logistiques - Logistic informations



3 431542 1152174

Box 525x330x295 mm | Master 5x2,24 kg | Pal 550 pcs | Ctr 20ft 6810 pcs

# Perceuse sans fil - Cordless drill - CDL 18E

35 N/m  
18 V



## PRODUIT MALIN SMART PRODUCT

ADAPTATEUR POUR ASPIRATEUR  
ADAPTER FOR VACUUM CLEANER

ø 39 mm maxi



3431541159228

- ▶ **Couple : 35 N/m**  
Torque: 35 N/m
- ▶ **Fonction percussion**  
Impact function
- ▶ **2 vitesses mécaniques et 18+1 réglages de couple**  
2 mechanical speeds and 18+1 torque adjustments
- ▶ **2 batteries et chargeur 1 heure**  
2 batteries and 1 hour charger
- ▶ **LED d'éclairage**  
Lighting LED



Livrée en mallette plastique + 13 accessoires  
Delivered in blowmould case with 13 accessories



LED d'éclairage  
LED Lighting



**LED**  
Light



**RUBBER**  
Grip



**SPEED**  
Control



**REVERSE**  
Réversible



**2 Speeds**  
2 Vitesses



**PERCU.**  
Impact

Perceuse sans fil Lithium-ion - Li-Ion cordless drill	CDL 18E
Gencode	<b>3431542155182</b>
Tension et puissance de la batterie - Battery voltage and power	<b>18 V - 1,5 Ah</b>
Temps de charge indicatif - Indicative charge time	<b>1 H</b>
Mandrin autoserrant avec frein - Keyless chuck with brake	<b>ø 10 mm</b>
Vitesses mécaniques - Mechanical speeds	<b>x 2</b>
Variateur de vitesse électronique Electronic variable speed	<b>0-400 tr.min<sup>-1</sup> 0-1500 tr.min<sup>-1</sup></b>
Fonction percussion Impact function	<b>0-6400 cps.min<sup>-1</sup> 0-24000 cps.min<sup>-1</sup></b>
Réglage de couple Torque settings	<b>x 18 + 1 35 N/m</b>

Données logistiques - Logistic informations



3 431542 1155182

Box 525x330x295 mm | Master 5x3,36 kg | Pal 100 pcs | Ctr 20ft 2735 pcs

DÉCAPAGE  
STRIPPING

ÉLECTROPORTEATIF  
HANDPOWER TOOLS

X-FIT  
RANGE

ATELIER  
WORKSHOP

BOIS  
WOOD MACHINES

MÉTAL  
METAL MACHINES

NETTOYAGE  
CLEANING

MÉTIER  
MANUAL WORK

JARDIN FILAIRE  
GARDEN TOOLS

Plus d'info sur  
**far.tools.com**

# Perceuse sans fil - Cordless drill - LI 55NB

55 N/m  
18 V



«Un produit complet : puissant, bonne maniabilité et grande autonomie.»  
Frédéric R.

**PRODUIT MALIN**  
SMART PRODUCT

ADAPTEUR POUR ASPIRATEUR  
ADAPTER FOR VACUUM CLEANER

ø 39 mm maxi

+

3431541159228

- ▶ **Couple : 55 N/m**  
Torque: 55 N/m
- ▶ **Fonction percussion**  
Impact function
- ▶ **2 vitesses mécaniques et 21+3 réglages de couple**  
2 mechanical speeds and 21+3 torque adjustments
- ▶ **2 batteries et chargeur 1 heure**  
2 batteries and 1 hour charger
- ▶ **LED d'éclairage**  
Lighting LED



Livrée en mallette plastique + 13 accessoires  
Delivered in blowmould case with 13 accessories



LED d'éclairage  
LED lighting

**2 Batteries :**  
4,0 Ah Charge 120 min  
2,0 Ah Charge 60 min



2 batteries : 4,0 Ah + 2,0 Ah  
2 batteries: 4,0 Ah + 2,0 Ah



**LED**  
Light



**RUBBER**  
Grip



**SPEED**  
Control



**REVERSE**  
Réversible



**2 Speeds**  
2 Vitesses



**PERCU.**  
Impact

**BRUSHLESS**  
**MOTOR**

**Moteur sans charbon**

Perceuse sans fil Lithium-ion - Li-Ion cordless drill	LI 55NB
Gencode	3431542155229
Tension et puissance de la batterie Battery voltage and power	18 V - 4.0 Ah 2 x Li-Ion (4.0 + 2.0 Ah)
Temps de charge indicatif Indicative charge time	60 min - 2.0 Ah 120 min - 4.0 Ah
Mandrin autoserrant avec frein - Keyless chuck with brake	ø 13 mm
Variateur de vitesse électronique Electronic variable speed	0-450 tr.min <sup>-1</sup> 0-2000 tr.min <sup>-1</sup>
Fonction percussion Impact function	0-6000 cps.min <sup>-1</sup> 0-22500 cps.min <sup>-1</sup>
Réglage de couple Torque settings	x 21 + 3 55 N/m

Données logistiques - Logistic informations



3 431542 1155229

Box 310x100x270 mm | Master 5x3,70 kg | Pal 100 pcs | Ctr 20ft 2735 pcs

# Clef à choc - Impact driver - CH 250A

250 N/m  
18 V - 4.0 Ah

Machine  
**ULTRA COMPACTE**

**MOTEUR SANS CHARBON**  
**BRUSHLESS MOTOR**

Jusqu'à 50 % de performance en plus / Till 50 % of performance  
Puissance accrue de 30 % / Till 30 % performance  
4 fois plus de longévité du produit / 4 Time longer durability \*



**NOUVEAU**



Moteur BRUSHLESS  
BRUSHLESS Motor



Indicateurs de charge  
Charge indicator



Eclairage LED  
LED Lighting

- ▶ Couple 250 N/m  
Torque 250 N/m
- ▶ 4 vitesses / cadences de frappe + fonction 1/4 de tour  
4 speeds / striking rates + 1/4 turn function
- ▶ Moteur BRUSHLESS  
BRUSHLESS motor
- ▶ Chargeur 2 heures  
2 hours charger
- ▶ Emmanchement 1/2"  
Chuck 1/2"
- ▶ Inverseur de sens et système de dévissage contrôlé  
Sense inverter and controlled unscrewing system

Livrée avec chargeur, 1 batterie 4.0 Ah  
Delivered with charger, one 4.0 Ah battery



**RUBBER**  
Grip



**SPEED**  
Control



**REVERSE**  
Réversible



**BRUSHLESS**  
MOTOR  
Moteur sans charbon



**PERCU.**  
Impact



**LED**  
Light

Clef à choc - Impact wrench	CH 250A
Gencode	3431542152242
Tension et puissance de la batterie Battery voltage and power	18 V - 4.0 Ah Li-ion
Temps de charge indicatif - Indicative charge time	120 min - 4.0 Ah
Cadence de frappe Percussion speeds	0-800 cps.min <sup>-1</sup> 0-1600 cps.min <sup>-1</sup> 0-2400 cps.min <sup>-1</sup> 0-3200 cps.min <sup>-1</sup>
Réglage de couple - Torque settings	250 N.m
Données logistiques - Logistic informations	
Box 310x100x270 mm   Master 5x3,70 kg   Pal 100 pcs   Ctr 20ft 2735 pcs	
3 431542 152242	
Consommables - Consumables	
Batterie 4.0 Ah - 4.0 Ah battery	3431542151962

DÉCAPAGE  
STRIPPING

ÉLECTROPORTATIF  
HANDPOWER TOOLS

X-FIT  
RANGE

ATELIER  
WORKSHOP

BOIS  
WOOD MACHINES

MÉTAL  
METAL MACHINES

NETTOYAGE  
CLEANING

MÉTIERS  
MANUAL WORK

JARDIN FILAIRE  
GARDEN TOOLS

Plus d'info sur  
**far.tools.com**



# Perceuse / Visseuse - Drill - PVF 280B

14 N/m  
280 W



- ▶ **Travail en continu et légèreté : câble 10 mètres**  
Light and streaming work: 10 meter cable
- ▶ **Fonction perçage pour le bois et le métal**  
Drilling function for wood and metal
- ▶ **23 réglages de couple pour s'adapter à tous les matériaux**  
23 torque adjustments for all materials adaptation
- ▶ **Mandrin auto-serrant 10 mm**  
10 mm keyless chuck
- ▶ **Variateur électronique de vitesse pour un vissage facilité**  
Electronic variable speed for easier screwing

Livrée en boîte couleur  
Delivered in color box



**RUBBER**  
Grip



**SPEED**  
Control



**REVERSE**  
Réversible

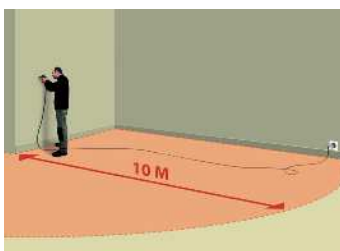

Perceuse / Visseuse - Drill		PVF 280B
	Gencode	<b>3431541150119</b>
Puissance du moteur - Motor power		<b>280 W</b>
Mandrin auto-serrant avec frein - Keyless chuck with brake		<b>ø 10 mm</b>
Variateur de vitesse électronique - Electronic variable speed		<b>0-750 tr.min<sup>-1</sup></b>
Réglage de couple - Torque settings		<b>14 N.m (x 23)</b>
Longueur de câble - Cable length		<b>10 m</b>

Données logistiques - Logistic informations



3 431541 1150119

Box 174x80x120 mm | Master 8x2,10 kg | Pal 240 pcs | Ctr 20ft 5830 pcs

# Clé à choc - Impact wrench - CH 500

500 N/m  
710 W



**Couple maxi 500 N.m**  
**Max torque 500 N.m**

- ▶ **Couple élevé : 500 N.m**  
High torque : 500 N.m
- ▶ **Câble caoutchouc résistant 5 m**  
5 meters of rubber cable
- ▶ **Cadence de frappe : Max. 3000 coups.min-1**  
Strike rate: Max. 3000 hit.min-1
- ▶ **Variateur électronique de vitesse pour un vissage facilité**  
Electronic variable speed for easier screwing
- ▶ **Carré de 1,2"**  
1,2" square
- ▶ **LED d'éclairage**  
Lighting LED

Livrée avec 3 douilles (13/17/18 mm)  
Delivered with 3 sockets (13/17/18 mm)



Couple élevé : 500 N.m  
High torque : 500 N.m



**RUBBER**  
Grip



**SPEED**  
Control

Clé à choc - Impact wrench	CH 500
Gencode	3431541150058
Puissance du moteur - Motor power	710 W
Variateur de vitesse électronique - Electronic variable speed	0-3000 tr.min <sup>-1</sup>
Force - Power	500 N.m
Longueur de câble - Cable length	5 m

Données logistiques - Logistic informations



3 431541 150058

Box 310x100x270 mm | Master 5x4,40 kg | Pal 88 pcs | Ctr 20ft 2400 pcs

DÉCAPAGE  
STRIPPING

ÉLECTROPORATIF  
HANDPOWER TOOLS

X-FIT  
RANGE

ATELIER  
WORKSHOP

BOIS  
WOOD MACHINES

MÉTAL  
METAL MACHINES

NETTOYAGE  
CLEANING

MÉTIERS  
MANUAL WORK

JARDIN FILAIRE  
GARDEN TOOLS

Plus d'info sur  
**fartools.com**

## Adaptateur angulaire de perçage - Angle drill adapter

ø 1,5 - 10 mm



Brochable  
Pegboardable

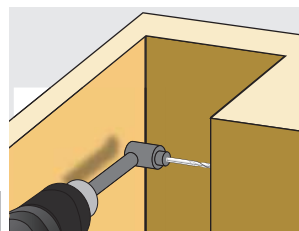

- ▶ **Axe sur roulements à billes**  
Ball bearing shaft
- ▶ **Mandrin auto-serrant**  
Keyless chuck
- ▶ **Perçage dans les zones difficiles**  
For hard to drill areas

Adaptateur angulaire de perçage - Angle drill adapter

115891

Gencode

3431541158917

Mandrin auto-serrant avec frein - Keyless chuck with brake

ø 1,5 - 10 mm

Données logistiques - Logistic informations



Box 50x135x245 mm | Master 16 x 0,5 kg | Pal 288 | Ctr 20ft 30900 pcs

## Adaptateur angulaire de vissage - Angle screwdriver



Brochable  
Pegboardable

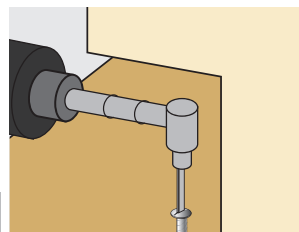

- ▶ **Tête rotative 360° et verrouillable en position**  
Rotative head and lockable position
- ▶ **Vissage dans les zones difficiles**  
For hard to screw areas

Adaptateur angulaire de vissage - Angle screwdriver

115892

Gencode

3431541158924

Données logistiques - Logistic informations



Box 138x115x190 mm | Master 30 x 0,20 kg | Pal 840 | Ctr 20ft 32940 pcs

## Récupérateur de poussières pour perceuse

Dust collector - ø 16 mm maxi



**ASPIRATION**  
— EFFET VENTOUSE —  
**100% D'EFFICACITÉ**



- ▶ Compatible toutes perceuses visseuses  
For all cordless drills
- ▶ Compatible flexible d'aspirateur de ø 26 à 39 mm  
Compatible vacuum cleaner hose from ø 26 to 39 mm

Récupérateur de poussières pour perceuse <i>Dust collector for drill</i>	115922
Gencode	<b>3431541159228</b>
Compatible toutes perceuses visseuses For all cordless drills	ø 16 mm maxi
<i>Données logistiques - Logistic informations</i>	
	
Box 235x80x35 mm   Master 40x0,28 kg Pal 3500   Ctr 20ft 25000 pcs	

## Récupérateur de gravats marteau perforateur

Dust collector - ø 70 mm maxi

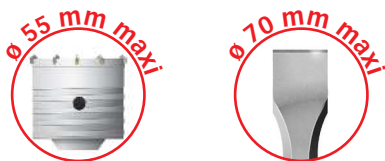

**ASPIRATION**  
— EFFET VENTOUSE —  
**100% D'EFFICACITÉ**



- ▶ Compatible tous marteaux perforateurs  
For all rotary hammers
- ▶ Compatible flexible d'aspirateur de ø 26 à 39 mm  
Compatible vacuum cleaner hose from ø 26 to 39 mm

Récupérateur de gravats marteau perforateur <i>Dust collector - ø 70 mm maxi</i>	115923
Gencode	<b>3431541159235</b>
Compatible tous perforateurs For all rotary hammers	ø 55/70 mm maxi
<i>Données logistiques - Logistic informations</i>	
	
Box 295x125x100 mm   Master 30x0,57 kg Pal 300   Ctr 20ft 20000 pcs	

DÉCAPAGE  
STRIPPING

ÉLECTROPORATIF  
HANDPOWER TOOLS

X-FIT  
RANGE

ATELIER  
WORKSHOP

BOIS  
WOOD MACHINES

MÉTAL  
METAL MACHINES

NETTOYAGE  
CLEANING

MÉTIER  
MANUAL WORK

JARDIN FILAIRE  
GARDEN TOOLS

Plus d'info sur  
**far**tools.com

# Perceuse percussion - Impact drill - PP 900D

0 - 3000 min<sup>-1</sup>  
900 Watts

**NOUVEAU**



**PRODUIT MALIN**  
SMART PRODUCT

ADAPTATEUR POUR ASPIRATEUR  
ADAPTER FOR VACUUM CLEANER

ø 39 mm maxi

+ →

3431541159228

- ▶ Mandrin métal auto-serrant verrouillable ø 13 mm  
ø 13 mm Self-locking lockable metal chuck
- ▶ Variateur de vitesse électronique  
Electronic variable speed
- ▶ Fonction percussion  
Impact function
- ▶ Poignée amovible et orientable 360°  
Handle removable and swivel 360°
- ▶ Vissage-dévisage  
Screw-unscrew

Livrée en boîte couleur  
Delivered in color box



Fonction percussion  
Impact function

<b>RUBBER</b> Grip	<b>SPEED</b> Control	<b>REVERSE</b> Réversible	<b>PERCU.</b> Impact	<b>Speed</b> Vitesse



Vitesse variable ajustable  
Variable speed for every materials

Perceuse percussion - Impact drill	PP 900
Gencode	<b>3431541153745</b>
Puissance du moteur - Motor power (230V-50Hz)	900 W
Variateur de vitesse électronique - Electronic variable speed	0 - 3000 min <sup>-1</sup>
Vitesses mécaniques - Mechanical speed	x 1
Fonction percussion - Impact function	0-48000 hit.min <sup>-1</sup>
Mandrin auto-serrant avec frein - Keyless chuck with brake	ø 13 mm
Mandrin verrouillable - Chuck locking	✓
<b>Données logistiques - Logistic informations</b>	



Box 305x90x350 mm | Master 4 x 3,40 kg | Pal 96 | Ctr 20ft 2584 pcs

# Perceuse percussion - Impact drill - PKP 1200B

0 - 1200 / 0 - 3200 min<sup>-1</sup>  
1200 Watts



**PRODUIT MALIN**  
SMART PRODUCT

ADAPTEUR POUR ASPIRATEUR  
ADAPTER FOR VACUUM CLEANER

ø 39 mm maxi

+

3431541159228

- ▶ **Tête métal**  
Metal head
- ▶ **Mandrin métal autoserrant verrouillable ø 13 mm**  
ø 13 mm Self-locking lockable metal chuck
- ▶ **Variateur de vitesse électronique**  
Electronic variable speed
- ▶ **Fonction percussion**  
Impact function
- ▶ **Poignée amovible et orientable 360°**  
Handle removable and swivel 360°
- ▶ **2 vitesses mécaniques**  
2 mechanical speed

Livrée en mallette avec accessoires  
Delivered with accessories



2 vitesses mécaniques  
2 mechanical speeds

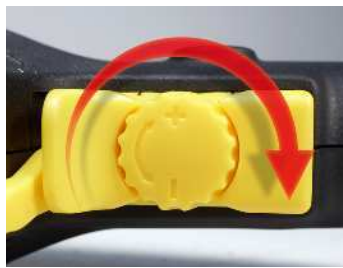

Vitesse variable ajustable  
Variable speed for every materials

- Grip**  
RUBBER Grip
- SPEED**  
Control
- REVERSE**  
Réversible
- PERCU.**  
Impact
- 2 Speeds**  
2 Vitesses

Perceuse percussion - Impact drill	PKP 1200B
Gencode	<b>3431541153820</b>
Puissance du moteur - Motor power (230V-50Hz)	1200 W
Variateur de vitesse électronique Electronic variable speed	0 - 1200 min <sup>-1</sup> 0 - 3200 min <sup>-1</sup>
Vitesses mécaniques - Mechanical speed	x 2
Fonction percussion Impact function	0 - 19200 hit.min <sup>-1</sup> 0 - 51200 hit.min <sup>-1</sup>
Mandrin auto-serrant avec frein - Keyless chuck with brake	ø 13 mm

Données logistiques - Logistic informations



3 431541153820

Box 460x450x380 mm | Master 4 x 5,0 kg | Pal 48 | Ctr 20ft 1500 pcs

DÉCAPAGE  
STRIPPING

ÉLECTROPORTATIF  
HANDPOWER TOOLS

X-FIT  
RANGE

ATELIER  
WORKSHOP

BOIS  
WOOD MACHINES

MÉTAL  
METAL MACHINES

NETTOYAGE  
CLEANING

MÉTIERS  
MANUAL WORK

JARDIN FILAIRE  
GARDEN TOOLS

Plus d'info sur  
**far**tools.com

# Marteau perforateur SDS - SDS rotary hammer - MP 50F

3,5 J  
1050 Watts

**NOUVEAU**

EXISTE AUSSI EN  
VERSION BATTERIE  
ALSO AVAILABLE IN  
BATTERY VERSION

18 V  
Battery System  
**X-FIT**



- ▶ 4 fonctions : Perçage - Perçage + percussion - Burinage - Burinage fixe  
4 fonctions : Drilling - Drilling + impact drill - Impact - Locked impact
- ▶ Force de frappe : 3,5 J  
High power: 3,5 J
- ▶ Poignée avant amovible et orientable à 360 °  
Removable and 360 ° swivel front handle
- ▶ Embout SDS  
SDS plug
- ▶ Vissage-dévisage  
Screw-unscrew
- ▶ Variateur de vitesse électronique  
Electronic variable speed

Livré avec poignée, guide de profondeur, 3 forets 150 mm ø 8/10/12 mm et 2 burins 250 mm  
Delivered with handle, depth gauge, three 150 mm drills ø 8/10/12 mm and two 250 mm chisels



x 4 fonctions  
x 4 fonctions



Vitesse variable ajustable  
Variable speed for every materials

Marteau perforateur SDS - SDS Rotary hammer		MP 50F
Gencode		3431541153660
Puissance du moteur - Motor power (230V-50Hz)		1050 W   3,5 J
Variateur de vitesse électronique - Electronic variable speed		0 - 1100 min <sup>-1</sup>
Fonction percussion - Impact function		0 - 5100 hit.min <sup>-1</sup>
Nombre de fonctions - Functions number		x 4
Système anti-vibration - Anti vibrations system		OK
Vissage-dévisage - Screw-unscrew		OK
Données logistiques - Logistic informations		
3 431541153660 Box 480x420x280 mm   Master 4 x 5,25 kg   Pal 80 pcs   Ctr 20ft 1650 pcs		
Consommables - Consumables		
Mandrin à clef 13 mm - Key chuck		3431541158009
Spatule métal SDS+ 75 mm - Metal spatula SDS+ 75 mm		3431541157835

# Marteau perforateur SDS - SDS rotary hammer - HY 1500D

6,0 J  
1600 Watts



## PRODUIT MALIN SMART PRODUCT

ADAPTATEUR POUR ASPIRATEUR  
ADAPTER FOR VACUUM CLEANER

ø 70 mm maxi



34315411592:5



x 4 fonctions  
x 4 fonctions



Poignée anti-vibration  
Anti vibrations system

- ▶ Grande puissance : 6,0 J  
High power: 6,0 J
- ▶ Système anti-vibrations  
Anti vibrations system
- ▶ Poignée avant amovible et orientable à 360 °  
Removable and 360 ° swivel front handle
- ▶ 4 fonctions : Perçage + Percussion / Percussion + burinage  
Burinage / Ajustement angle burin  
4 functions: Drilling + Percussion / Percussion + Chiseling  
Chiseling / Chisel angle adjustment
- ▶ Tête en métal  
Metal head
- ▶ Mandrin SDS  
SDS chuck



Livré en mallette avec accessoires : 3 forets SDS + 2 burins (plat et pointu)  
Delivered with accessories: 3 SDS drills + 2 chisels (flat and pointed)

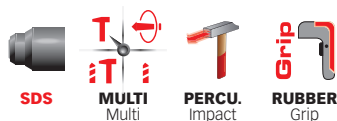

SDS

MULTI  
Multi

PERCU.  
Impact

GRIP  
Grip

Marteau perforateur SDS - SDS Rotary hammer

HY 1500D

Gencode

3431541154759

Puissance du moteur - Motor power (230V-50Hz)

1600 W | 6,0 J

Vitesse de rotation - Rotation speed

800 min<sup>-1</sup>

Fonction percussion - Impact function

4000 hit.min<sup>-1</sup>

Multifonctions - Multifunctions

x 4

Niveau de bruit - Noise level (dB)

96-107 (+/-3,0)

Données logistiques - Logistic informations



3 431541154759

Box 430x130x340 mm | Master 2 x 8,0 kg | Pal 48 | Ctr 20ft 1350 pcs

Consommables - Consumables

Mandrin à clef 13 mm - Key chuck

3431541158009

DÉCAPAGE  
STRIPPING

ÉLECTROPORATIF  
HANDPOWER TOOLS

X-FIT  
RANGE

ATELIER  
WORKSHOP

BOIS  
WOOD MACHINES

MÉTAL  
METAL MACHINES

NETTOYAGE  
CLEANING

MÉTIERS  
MANUAL WORK

JARDIN FILAIRE  
GARDEN TOOLS

Plus d'info sur  
fartools.com



# Marteau perforateur SDS MAX - SDS MAX rotary hammer - RH10 MAX

10,0 J  
1600 Watts



«Que du positif !  
Poids contenu, peu de vibrations  
et hyper efficace.»  
Laurent L.



**PRODUIT MALIN**  
SMART PRODUCT

ADAPTEUR POUR ASPIRATEUR  
ADAPTER FOR VACUUM CLEANER

Ø 70 mm maxi

+

3431541159235



x 3 fonctions  
x 3 fonctions



Poignée anti-vibration  
Anti vibrations system

- ▶ Grande puissance : 10,0 J  
High power: 10,0 J
- ▶ Embout SDS MAX  
SDS MAX plug
- ▶ Système anti-vibration  
Anti vibration system
- ▶ Poignée avant orientable à 360°  
360° Swivel front handle
- ▶ 3 fonctions : Percussion/burinage - Burinage - Burinage fixe  
3 functions: ImpactDrill - Chipping - Fixed impact
- ▶ Tête en métal  
Metal head



Livré en mallette avec accessoires  
Delivered with accessories

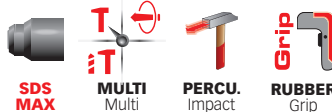

SDS  
MAX

MULTI  
Multi

PERCU.  
Impact

GRIP  
RUBBER  
Grip

Marteau perforateur SDS MAX - SDS MAX Rotary hammer	RH10 MAX
Gencode	3431541153905
Puissance du moteur - Motor power (230V-50Hz)	1600 W   10,0 J
Vitesse de rotation - Rotation speed	630 min <sup>-1</sup>
Fonction percussion - Impact function	3800 hit.min <sup>-1</sup>
Multifonctions - Multifunctions	x 3
Niveau de bruit - Noise level (dB)	88 - 99 (+/-3,0)
Données logistiques - Logistic informations	
Box 450x384x132 mm   Master 2 x 7,30 kg   Pal N.C.   Ctr 20ft 400 pcs	
Consommables - Consumables	
Spatule métal pour SDS max (18 x 400 x 150 mm) - SDS MAX Spatula	3431541157829



3 431541 153905

# Accessoires gamme CONSTRUCTION

## CONCRETE RANGE ACCESSORIES

### Accessoires récupérateurs de poussières

Dust collector accessories

Onglet Métiers, gamme béton - Manual work tag, concrete range



Ref 115922 (p 210)



Ref 115923 (p 210)



Ref 115924 (p 202)

Ref 115926 (p 202)



Ref 115925 (p 202)

### Accessoires pour buriner et décoller

Accessories for chiseling and peeling

Onglet Métiers, gamme béton - Manual work tag, concrete range



Ref 115780 (p 197)



Ref 115781 (p 197)



Ref 115782 (p 197)



Ref 115783 (p 197)

### Retrouvez toutes les références d'accessoires pour la gamme béton :

Ces 2 gammes indispensables dans votre chantier béton vous apporteront un confort d'utilisation inégalé. Fini la poussière quand vous percez un mur de parpaing, de béton ou de brique ! Les carters avec aspiration vous éviteront désormais ces désagréments.

Vous trouverez également des accessoires très pratiques pour décoller de la colle à carrelage, traces de colle ou restes de béton à la surface d'une dalle, ou encore pour damer un sol en terre ou en gravier avant de couler votre chape. Ceux ci s'adaptent sur des mandrins SDS PLUS, SDS MAX et HEX 30.

#### Find all the references of accessories for concrete range:

These 2 essentials ranges in your concrete work site will provide you with unparalleled ease of use. No more dust when you drill a cinder block, concrete or brick wall! Suction housings will now avoid these inconveniences.

You will also find very practical accessories for removing tile adhesive, traces of glue or remains of concrete from the surface of a slab, or for tamping an earth or gravel floor before pouring your slab. These fit on SDS PLUS, SDS MAX and HEX 30 chucks.

DÉCAPAGE  
STRIPPING

ÉLECTROPORATIF  
HANDPOWER TOOLS

X-FIT  
RANGE

ATELIER  
WORKSHOP

BOIS  
WOOD MACHINES

MÉTAL  
METAL MACHINES

NETTOYAGE  
CLEANING

MÉTIERS  
MANUAL WORK

JARDIN FILAIRE  
GARDEN TOOLS

Plus d'infos sur  
**fartools.com**

# Surfaceuse multi-matériaux - Multi materials surfer - PMF 1300

ø 125/150 mm  
1400 Watts



«Produit polyvalent, avec travail en bordure sans poussière.»

Damien M.



PLÂTRE  
PLASTER

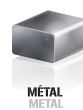

MÉTAL  
METAL



BOIS  
WOOD



BÉTON  
CONCRETE

- ▶ Multifonctions : multimatériaux  
Multifunctions: multimaterials
- ▶ Ponçage en bordure  
Edge sanding
- ▶ Poignée ajustable et ergonomique  
Adjustable and ergonomic handle
- ▶ Connectable à un aspirateur à décolmatage  
Connectable to a unclogging vacuum cleaner
- ▶ Carter indexable sans outils  
Case to be swivelled without a tool
- ▶ Variateur de vitesse électronique  
Electronic variable speed

Livrée en mallette avec 8 accessoires  
Delivered in BMC with 8 accessories



ø 125 mm

Carter escamotable, pour le ponçage en bordure  
Removable carter, for edge sanding



DUST  
Collector



BMC  
Mallette



SPEED  
Control



Arbor  
Lock



Surfaceuse multi-matériaux - Multi materials surfer		PMF 1300
Gencode	343154	1150324
Puissance du moteur - Motor power (230V-50Hz)	1400 W	
Variateur de vitesse électronique - Electronic variable speed	3000 - 10000 min <sup>-1</sup>	
Dimensions disque (ponçage-meulage) - Disc sizes (sanding - grinding)	ø 125 x 22,2 mm	
Dimensions du disque (polissage - lustrage) - Disc sizes (polishing - finishing)	ø 150 mm	
Diamètre de l'arbre - Arbor diameter	M14	
Blocage d'arbre - Arbor lock	OK	

Données logistiques - Logistic informations

3 431541 150324 | Box 1100x260x260 mm | Master 1 x 4,4 kg | Pal 18 pcs | Ctr 20ft 330 pcs

Consommables - Consumables

Disque béton - Concrete disc	3431541158894
Set 6 abrasifs : 2xA80 / 2x120 / 2x180 - 6 Abrasive pads	3431541159174
Brosse ø 100 mm - 100 mm brush	3431547500376
Bonnet à lustrer 150 mm - 150 mm polishing cap	3431541159211

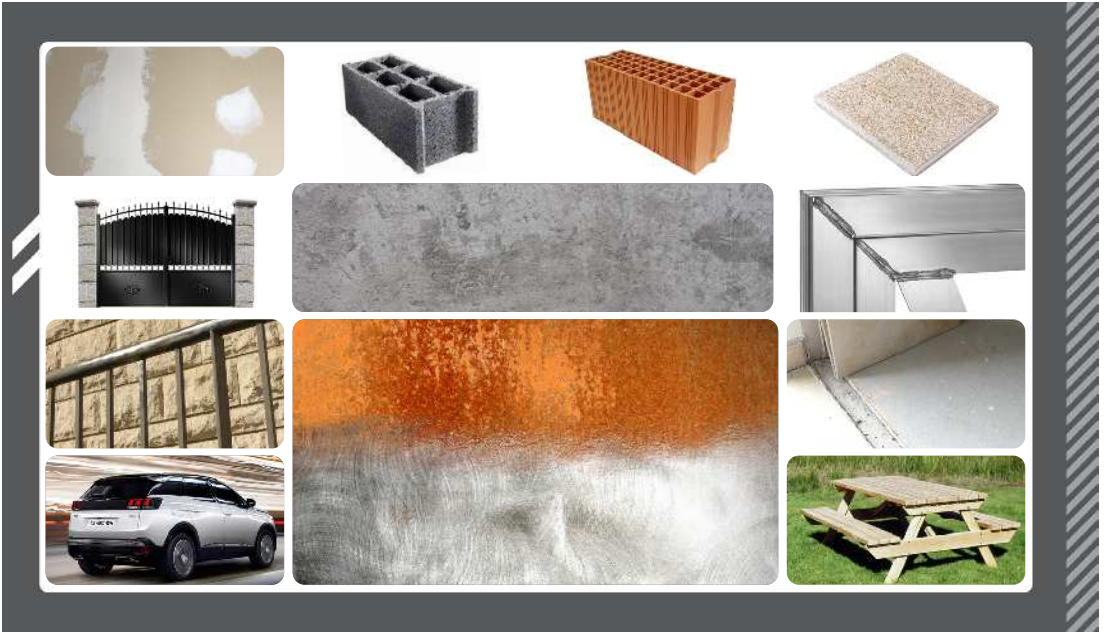

# Une Machine pour de multiples matériaux...



**Polissage automobile (ø 150 mm)**  
Polishing





**Surfaceuse béton (ø 125 mm)**  
Concrete surfacers



**Décapage du métal (ø 75 mm)**  
Metal cleaning



**Ponçage du plâtre avec aspiration**  
Plaster sanding with suction

**Meulage du métal (ø 125 mm)**  
Metal grinding



**Ponçage du bois (ø 125 mm)**  
Wood sanding



# Meuleuse d'angle - Angle grinder - KH 115E

ø 115 mm  
750 Watts



EXISTE AUSSI EN  
VERSION BATTERIE  
ALSO AVAILABLE IN  
BATTERY VERSION



Meuleuse 1 main  
One hand angle grinder



Carter indexable sans outils  
Keyless swivelled carter

**NOUVEAU**



- ▶ Meuleuse 1 main = très maniable  
One hand angle grinder = very handy
- ▶ Blocage d'arbre  
Arbor lock
- ▶ Poignée 2 positions  
Handle 2 positions
- ▶ Carter indexable sans outil  
Case to be swivelled without a tool



**Arbor  
Lock**

Meuleuse d'angle - Angle grinder	KH 115E
Gencode	<b>3431541150454</b>
Puissance du moteur - Motor power (230V~50Hz)	<b>750 W</b>
Vitesse de rotation - Rotation speed	<b>12000 tr.min<sup>-1</sup></b>
Diamètre / alésage de la lame - Blade diameter / bore	<b>ø 115 / 22,2 mm</b>
Diamètre de l'arbre - Arbor diameter	<b>M14</b>
Nombre de position de poignée - Handle positions number	<b>x 2</b>
Blocage d'arbre - Arbor lock	<b>OK</b>
Données logistiques - Logistic informations	



Box 120x100x320 mm | Master 6 x 2,3 kg | Pal 216 | Ctr 20ft 4320 pcs

# Meuleuse d'angle - Angle grinder - TM 05E

ø 125 mm  
900 Watts



EXISTE AUSSI EN  
VERSION BATTERIE  
ALSO AVAILABLE IN  
BATTERY VERSION



- ▶ Grande puissance : 900 W  
High power: 900 W
- ▶ Blocage d'arbre  
Arbor lock
- ▶ Poignée 2 positions  
Handle 2 positions
- ▶ Carter indexable sans outil  
Case to be swivelled without a tool

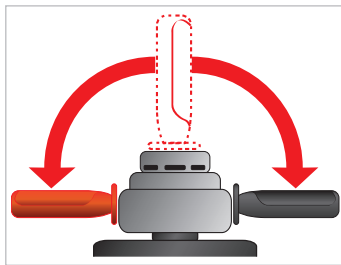

Poignée 2 positions  
2 positions handle



Carter indexable sans outils  
Keyless swivelled carter



Arbor  
Lock

Meuleuse d'angle - Angle grinder	TM 05E
Gencode	3431541150300
Puissance du moteur - Motor power (230V-50Hz)	900 W
Vitesse de rotation - Rotation speed	11000 tr.min <sup>-1</sup>
Diamètre / alésage de la lame - Blade diameter / bore	ø 125 / 22,2 mm
Diamètre de l'arbre - Arbor diameter	M14
Nombre de position de poignée - Handle positions number	x 2
Blocage d'arbre - Arbor lock	OK
Données logistiques - Logistic informations	



3 431541 150300

Box 300x110x110 mm | Master 6 x 2,5 kg | Pal 216 | Ctr 20ft 3970 pcs

DÉCAPAGE  
STRIPPING

ÉLECTROPORATIF  
HANDPOWER TOOLS

X-FIT  
RANGE

ATELIER  
WORKSHOP

BOIS  
WOOD MACHINES

MÉTAL  
METAL MACHINES

NETTOYAGE  
CLEANING

MÉTIERS  
MANUAL WORK

JARDIN FLAIRE  
GARDEN TOOLS

Plus d'info sur  
**fartools.com**

# Meuleuse d'angle à vitesse variable - Angle grinder - KL 125

ø 125 mm  
900 Watts



- ▶ **Variateur de vitesse**  
Variable speed
- ▶ **Puissance et vitesse constante**  
Stable power and speed
- ▶ **Blocage d'arbre**  
Arbor lock
- ▶ **Poignée 2 positions anti-vibration**  
Vibration reduce handle with 2 positions
- ▶ **Carter indexable sans outil**  
Case to be swivelled without a tool

*Livrée avec poignée anti-vibration carter de tronçonnage et clé de serrage*  
Delivered with handle, cutting carter and tightening key



Poignée anti-vibration  
Vibration reduce handle



**SPEED**  
Control



**Arbor**  
Lock



Carter indexable sans outil  
Keyless swivelled carter

Meuleuse d'angle à vitesse variable Angle grinder with Variable speed		KL 125
Gencode	<b>3431541150416</b>	
Puissance du moteur - Motor power (230V-50Hz)	<b>900 W</b>	
Variateur de vitesse électronique - Electronic variable speed	<b>4500 - 11000 tr.min<sup>-1</sup></b>	
Diamètre / alésage de la lame - Blade diameter / bore	<b>ø 125 / 22,2 mm</b>	
Diamètre de l'arbre - Arbor diameter	<b>M14</b>	
Nombre de position de poignée - Handle positions number	<b>x 2</b>	
Blocage d'arbre - Arbor lock	<b>OK</b>	
Données logistiques - Logistic informations		



Box 325x125x122 mm | Master 6 x 2,98 kg | Pal 180 | Ctr 20ft 3970 pcs

# Meuleuse d'angle - Angle grinder - KH 125E

ø 125 mm  
1200 Watts

**NOUVEAU**

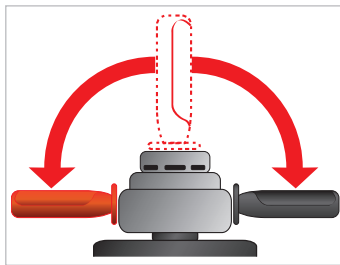

Poignée 3 positions  
3 positions handle



Carter indexable sans outil  
Keyless swivelled carter

- ▶ Blocage d'arbre  
Arbor lock
- ▶ Poignée 3 positions  
Handle 3 positions
- ▶ Carter indexable sans outil  
Case to be swivelled without a tool

Livrée avec poignée et clé de serrage  
Delivered with handle and tightening key



Arbor  
Lock

Meuleuse d'angle - Angle grinder	KH 125E
Gencode	<b>3431541150508</b>
Puissance du moteur - Motor power (230V-50Hz)	<b>1200 W</b>
Vitesse de rotation - Rotation speed	<b>11500 tr.min<sup>-1</sup></b>
Diamètre / alésage de la lame - Blade diameter / bore	<b>ø 125 / 22,2 mm</b>
Diamètre de l'arbre - Arbor diameter	<b>M14</b>
Nombre de position de poignée - Handle positions number	<b>x 3</b>
Blocage d'arbre - Arbor lock	<b>OK</b>
Données logistiques - Logistic informations	



Box 430x115x125 mm | Master 6 x 2,6 kg | Pal 120 | Ctr 20ft 2890 pcs

DÉCAPAGE  
STRIPPING

ÉLECTROPORATIF  
HANDPOWER TOOLS

X-FIT  
RANGE

ATELIER  
WORKSHOP

BOIS  
WOOD MACHINES

MÉTAL  
METAL MACHINES

NETTOYAGE  
CLEANING

MÉTIER  
MANUAL WORK

JARDIN FILAIRE  
GARDEN TOOLS

Plus d'info sur  
**far**tools.com



# Meuleuse d'angle - Angle grinder - KL 230E

ø 230 mm  
2350 Watts



Poignée orientable à +/- 90°  
Adjustable handle +/- 90°

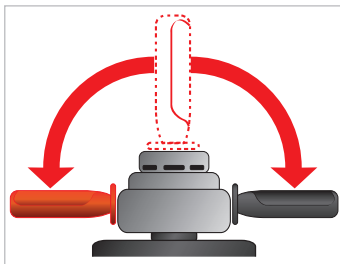

Poignée 3 positions  
3 positions handle



Carter indexable avec clé (fournie)  
Swivelled carter with key (provided)

- ▶ Poignée arrière orientable +/- 90°  
Adjustable handle +/- 90°
- ▶ Démarrage progressif  
Soft start
- ▶ Blocage d'arbre  
Arbor lock
- ▶ Poignée 3 positions / Poignée arrière rotative anti-vibration  
Handle 3 positions / Anti-vibration rotating rear handle
- ▶ Carter indexable  
Case to be swivelled

Livrée avec poignée et clé de serrage  
Delivered with handle and tightening key



**Arbor Lock**



**Soft Start**



**RUBBER Grip**

Meuleuse d'angle - Angle grinder	KL 230E
Gencode	<b>3431541150775</b>
Puissance du moteur - Motor power (230V-50Hz)	<b>2350 W</b>
Vitesse de rotation - Rotation speed	<b>5800 tr.min<sup>-1</sup></b>
Diamètre / alésage de la lame - Blade diameter / bore	<b>ø 230 / 22,2 mm</b>
Diamètre de l'arbre - Arbor diameter	<b>M14</b>
Nombre de position de poignée - Handle positions number	<b>x 3</b>
Blocage d'arbre - Arbor lock	<b>OK</b>

Données logistiques - Logistic informations



Box 510x280x190 mm | Master 2x5,5 kg | Pal 40 | Ctr 20ft 2000 pcs

# Mini meuleuse angulaire - Mini angular grinder - CS 76

ø 76 mm  
260 Watts



## Découpe MULTI-MATÉRIAUX



- ▶ **Disque multi-matériaux**  
Multi-material disc
- ▶ **Carter indexable sans outil**  
Carter to be swivelled without a tool
- ▶ **Blocage d'arbre**  
Arbor lock
- ▶ **Bouton de réarmement de la protection thermique**  
Thermal protection reset button
- ▶ **Prise en main ergonomique : poignée 1 main**  
Ergonomic: 1 hand handle

Livrée avec 1 disque multi-matériaux, 3 disques d'ébarbage et une clé de serrage  
Delivered with 1 multi-material disc and a tightening key



Poignée 1 main  
One hand handle



Carter indexable sans outils  
Keyless swivelled carter



**RELAY**  
Thermique



**RUBBER**  
Grip

Mini meuleuse angulaire - Mini angular grinder	<b>CS 76</b>
Gencode	<b>3431541154193</b>
Puissance du moteur - Motor power (230V-50Hz)	<b>260 W</b>
Vitesse de rotation - Rotation speed	<b>4500 tr.min<sup>-1</sup></b>
Diamètre / alésage de la lame - Blade diameter / bore	<b>ø 76 / 10 mm</b>
Diamètre de l'arbre - Arbor diameter	<b>M5</b>
Capacité de coupe maxi - Max cutting capacities	<b>90° = 15 mm</b>
Blocage d'arbre - Arbor lock	<b>OK</b>
Données logistiques - Logistic informations	
Box 228x88x126 mm   Master 8 x 1,62 kg   Pal 400   Ctr 20ft 5700 pcs	
Consommables - Consumables	
Disque ø 76 mm - 76 mm Disc	<b>3431541154162</b>
3 Disques abrasif / Diamant / TCT - Set of 3 TCT/Abrasive/ Diamond discs	<b>3431541154179</b>
5 Disques abrasifs - Set of 5 abrasive discs	<b>3431541154186</b>

DÉCAPAGE  
STRIPPING

ÉLECTROPORTATIF  
HANDPOWER TOOLS

X-FIT  
RANGE

ATELIER  
WORKSHOP

BOIS  
WOOD MACHINES

MÉTAL  
METAL MACHINES

NETTOYAGE  
CLEANING

MÉTIERS  
MANUAL WORK

JARDIN FILAIRE  
GARDEN TOOLS

Plus d'info sur  
**fartools.com**

# Meuleuse droite - Right angle grinder - MLD 750

ø 6/8 mm  
750 Watts



« Machine très efficace. Les accessoires sont très qualitatifs... »  
Wilfried Z.



Variateur de vitesse électronique  
Variable speed

- ▶ Bois et métal  
Wood and metal
- ▶ Idéal pour le meulage et fraisage du métal  
Ideal for grinding and milling metal
- ▶ Adapté pour le brossage et le polissage  
Suitable for brushing and polishing
- ▶ Variateur de vitesse électronique = utilisation facile  
Variable speed = easy to use
- ▶ Prise en main ergonomique  
Ergonomic

Livrée avec 3 brosses de ø 30 mm, 3 fraises au carbure de tungstène et clef de serrage  
Delivered with 3 brushes ø 30 mm, 3 carbide burs and key



**RUBBER**  
Grip



**SPEED**  
Control

**You Tube**



Meuleuse droite - Right angle grinder		MLD 750
Gencode	3431541150850	
Puissance du moteur - Motor power (230V-50Hz)	750 W	
Variateur de vitesse électronique - Electronic variable speed	10000 - 30000 min <sup>-1</sup>	
Dimensions du mandrin - Chuck sizes	ø 6 / 8 mm	
Données logistiques - Logistic informations		
 Box 420x90x90 mm   Master 10 x 2,1 kg   Pal 240   Ctr 20ft 6000 pcs		
Consommables - Consumables		
3 Fraises carbure de tungstène - 3 Tungsten Carbide Burs	3431541159150	
3 brosses 30x30 mm A120	3431541159167	

# Ponceuse delta - Delta sander - MS 200B

140x140x80 mm

220 Watts



DÉCAPAGE  
STRIPPING

ÉLECTROPORATIF  
HANDPOWER TOOLS

X-FIT  
RANGE

ATELIER  
WORKSHOP

BOIS  
WOOD MACHINES

MÉTAL  
METAL MACHINES

NETTOYAGE  
CLEANING

MÉTIERS  
MANUAL WORK

JARDIN FILAIRE  
GARDEN TOOLS

Plus d'info sur  
**far**tools.com

-51-

EXISTE AUSSI EN VERSION BATTERIE  
ALSO AVAILABLE IN BATTERY VERSION



XF-Delta - 216025 - P 107



- ▶ Filtration par cartouche à poussière  
Dust cartridge filter
- ▶ Permet un ponçage de finition de haute précision  
For finishing sanding, with high accuracy
- ▶ Fixation type Velcro  
Velcro grips
- ▶ Finition soft touch  
Soft finishing
- ▶ Poignée ergonomique  
Ergonomic handle

Livrée avec 2 feuilles abrasives grain 80 et collecteur de poussières  
Delivered with 2 sanding pads grit 80 and dust collector



**RUBBER**  
Grip



**VELCRO**



**Cartridge**  
Cartouche



Ponceuse delta - Delta sander	MS 200B
Gencode	3431541151369
Puissance du moteur - Motor power (230V~50Hz)	220 W
Vitesse de rotation - Rotation speed	0 - 13000 min <sup>-1</sup>
Dimension du patin - Pad sizes	140x140x80 mm
Données logistiques - Logistic informations	
Box 400x385x330 mm   Master 12 x 1,55 kg   Pal 360   Ctr 20ft 6930 pcs	
Consommables - Consumables	
6 Abrasifs A40 Velcro - Abrasives	3431541158597
6 Abrasifs A80 Velcro - Abrasives	3431541158603
6 Abrasifs A120 Velcro - Abrasives	3431541158610



# Ponceuse orbitale - Orbital sander - AJ 150C

ø 125 mm  
450 Watts



EXISTE AUSSI EN VERSION BATTERIE  
ALSO AVAILABLE IN BATTERY VERSION



XF-Orbital2 - 216033 - P 108



Filtration par cartouche  
Cartridge filtration



Fixation type Velcro  
Velcro grips

- ▶ Filtration par cartouche à poussière  
Dust cartridge filter
- ▶ Ponçage dégrossissage et mi-finition  
Sanding roughing and half-finishing
- ▶ Variateur de vitesse électronique  
Electronic variable speed
- ▶ Poignée ergonomique ajustable  
Adjustable ergonomic handle

Livrée avec 1 feuille d'abrasif grain 80 et 1 cartouche à poussières  
Delivered with abrasive sheet grit 80 and a dust box



**RUBBER**  
Grip



**VELCRO**



**SPEED**  
Control



**Cartridge**  
Cartouche

Ponceuse orbitale - Orbital sander		AJ 150C
	Gencode	<b>3431541151567</b>
Puissance du moteur - Motor power (230V-50Hz)		<b>450 W</b>
Variateur de vitesse électronique - Electronic variable speed		<b>0 - 13000 min<sup>-1</sup></b>
Dimension du patin - Pad sizes		<b>ø 125 mm</b>
Fixation par Velcro - Velcro grips		<b>OK</b>
Données logistiques - Logistic informations		
3 431541 1151567   Box 520x310x210 mm   Master 4 x 2,3 kg   Pal 140   Ctr 20ft 2440 pcs		
Consommables - Consumables		
6 Abrasifs A40 Velcro - Abrasives		<b>3431541158627</b>
6 Abrasifs A80 Velcro - Abrasives		<b>3431541158658</b>
6 Abrasifs A120 Velcro - Abrasives		<b>3431541158665</b>

# Ponceuse vibrante - Finishing sander - AJ 150C

114 x 228 mm  
330 Watts



Fixation par pinces  
Pad grips



Fixation type Velcro  
Velcro grips

- ▶ Filtration par cartouche à poussière  
Dust cartridge filter
- ▶ Pour ponçage moyen et finition  
For middle and finishing sanding
- ▶ Variateur de vitesse électronique  
Electronic variable speed
- ▶ Fixation type velcro ou par pince  
Velcro or pad grips
- ▶ Poignée ergonomique  
Ergonomic handle

Livré avec 1 feuille d'abrasif grain 80  
Delivered with abrasive sheet grit 80



**RUBBER**  
Grip

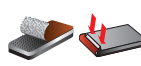

**VELCRO / PINCES**



**SPEED**  
Control



**Cartridge**  
Cartouche

Ponceuse vibrante XL - XL Finishing sander	<b>AJ 150C</b>
Gencode	<b>3431541151604</b>
Puissance du moteur - Motor power (230V~50Hz)	<b>330 W</b>
Variateur de vitesse électronique - Electronic variable speed	<b>6000 - 11000 min<sup>-1</sup></b>
Dimension du patin - Pad sizes	<b>114 x 228 mm</b>
Fixation par Velcro / pinces - Velcro / pad grips	<b>OK</b>
Données logistiques - Logistic informations	
Box 480x240x320 mm   Master 6 x 2,8 kg   Pal 128   Ctr 20ft 2640 pcs	
Consommables - Consumables	
10 Abrasifs A40 Velcro - Abrasives	<b>3431541158528</b>
10 Abrasifs A80 Velcro - Abrasives	<b>3431541158535</b>
10 Abrasifs A150 Velcro - Abrasives	<b>3431541158542</b>

DÉCAPAGE  
STRIPPING

ÉLECTROPORATIF  
HANDPOWER TOOLS

X-FIT  
RANGE

ATELIER  
WORKSHOP

BOIS  
WOOD MACHINES

MÉTAL  
METAL MACHINES

NETTOYAGE  
CLEANING

MÉTIERS  
MANUAL WORK

JARDIN FILAIRE  
GARDEN TOOLS

Plus d'infos sur  
**far**  
**tools.com**

# Lime électrique - Mini belt sander - YO 400

9/13 x 457 mm  
400 Watts



«Excellente prise en main. Efficace et tête orientable.»

Damien M.



Bras avec méplat  
Flat arm

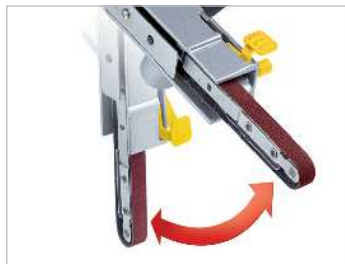

Bras orientable  
Tilting sanding arm

- ▶ **Bras de ponçage orientable**  
Tilting sanding arm
- ▶ 2 bras de ponçage : 2 largeurs de ponçage  
Easy carbon brushes removal
- ▶ Variateur de vitesse électronique  
Electronic variable speed
- ▶ Changement rapide de bande  
Quick belt replacement

Livré en sac tissu avec 2 bras (1 droit et 1 avec méplat)  
sac à poussières et 2 bandes abrasives  
Delivered in transport bag with 2 arms (1 right and 1 with flat)  
dust bag and 2 abrasive belts



Lime électrique - Mini belt sander		YO 400
Gencode	3431541154582	
Puissance du moteur - Motor power (230V-50Hz)	400 W	
Variateur de vitesse électronique - Electronic variable speed	300 - 1700 m.min <sup>-1</sup>	
Dimensions de la bande Belt sizes	9 x 457 mm 13 x 457 mm	
Sac à poussières - Dust bag	OK	
Données logistiques - Logistic informations		
Box 480x130x290 mm   Master 42 x 3,45 kg   Pal 60   Ctr 20ft 1700 pcs		
3 431541 154582		
Consommables - Consumables		
6 Abrasifs (13 et 9 mm) 2xA40,2xA80,2xA120 - Abrasives	3431541158801	
6 Bandes abrasives 9 mm 2xA40,2xA80,2xA120 - Abrasives	3431541158948	



# Ponceuse pour tube - Pipe sander - TBS 1300B

760 x 40 mm  
1300 Watts



« Excellents résultats.  
Machine très efficace,  
montage facile  
des bandes. »  
Diarmuid B.



Carter pour aspiration des poussières  
Housing for dust extraction

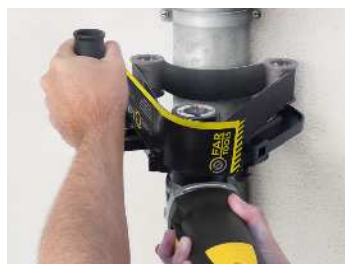

- ▶ Ponçage périphérique à 180° en 1 passe  
180° sanding zone in 1 time
- ▶ Variateur de vitesse électronique  
Electronic variable speed
- ▶ Bois et métal  
Wood and metal
- ▶ Ajustage automatique de la bande  
Belt automatic adjustment

Livrée avec 6 bandes abrasives assorties, pour bois et métal  
Delivered with 6 different abrasive belts, for wood and metal



Ponceuse pour tube - Pipe sander	<b>TBS 1300B</b>
Gencode	<b>3431541150256</b>
Puissance du moteur - Motor power (230V-50Hz)	<b>1300 W</b>
Variateur de vitesse électronique - Electronic variable speed	<b>1100 - 3200 min<sup>-1</sup></b>
Dimension de la bande - Belt sizes	<b>760x40 mm</b>
Capacité - Capacity	<b>ø 180 mm</b>
Données logistiques - Logistic informations	



Box 165x220x600 mm | Master 1 x 5,5 kg | Pal 84 | Ctr 20ft 1164 pcs

Consommables - Consumables	
3 Abrasifs oxyde d'Aluminium A120 bois,métal et peinture	<b>3431541159303</b>
3 Abrasifs oxyde d'Aluminium A180 bois,métal et peinture	<b>3431541159310</b>
3 Abrasifs oxyde d'Aluminium A240 bois,métal et peinture	<b>3431541159327</b>
3 Abrasifs oxyde de Zirconium A60 bois,métal et peinture	<b>3431541159334</b>
3 Abrasifs oxyde de Zirconium A80 métal non ferreux +inox	<b>3431541159341</b>



DÉCAPAGE  
STRIPPING

ÉLECTROPORATIF  
HANDPOWER TOOLS

X-FIT  
RANGE

ATELIER  
WORKSHOP

BOIS  
WOOD MACHINES

MÉTAL  
METAL MACHINES

NETTOYAGE  
CLEANING

MÉTIERS  
MANUAL WORK

JARDIN FILAIRE  
GARDEN TOOLS

Plus d'info sur  
**fartools.com**



# Ponceuse a bande - Belt sander - BS 810C

75 x 533 mm

900 Watts



Changement rapide  
Fast changing

- ▶ **Carter escamotable, pour zones difficiles...**  
Retractable carter, for difficult areas...
- ▶ **Rouleau plus petit, ponçage plus précis**  
Small roller, more accurate sanding
- ▶ **Changement rapide de bande**  
Quick belt replacement
- ▶ **Poignée ergonomique**  
Ergonomic handle
- ▶ **Variateur de vitesse électronique**  
Electronic variable speed

Livré avec 1 bande abrasive grain 80 et un sac à poussières  
Delivered with abrasive belt grit 80 and a dust bag



**RUBBER**  
Grip



**SPEED**  
Control



**Sac poussière**  
Dust bag

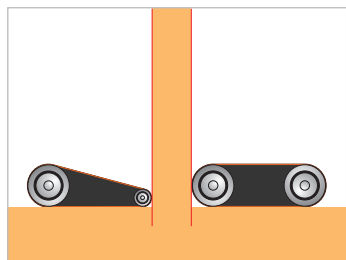

Rouleau plus petit, ponçage plus précis  
Small roller, more accurate sanding

Ponceuse a bande - Belt sander	BS 810C
Gencode	<b>3431541155602</b>
Puissance du moteur - Motor power (230V-50Hz)	<b>900 W</b>
Vitesse de rotation de la bande - Belt rotation speed	<b>200 - 380 min<sup>-1</sup></b>
Dimension de la bande - Belt sizes	<b>75 x 533 mm</b>
Données logistiques - Logistic informations	
Box 520x400x360 mm   Master 6 x 4,0 kg   Pal 96   Ctr 20ft 2844 pcs	
Consommables - Consumables	
6 Abrasifs 75x533 mm - Set of 6 abrasives 75x533 mm A40/80/120	<b>3431541158580</b>

# Rabot électrique - Electric planer - EP 850

82 x3 mm  
850 Watts



EXISTE AUSSI EN VERSION BATTERIE  
ALSO AVAILABLE IN BATTERY VERSION



XF-Planer - 216024 - P 105

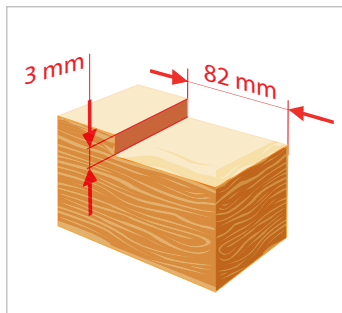
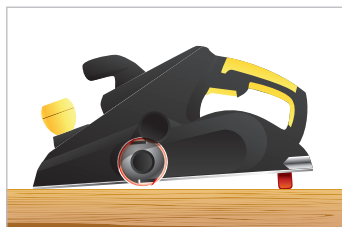

- ▶ Ejection Gauche / Droite des copeaux  
Right or left dust collector
- ▶ Position repos sécurisé  
Safety rest position
- ▶ Fonction chanfreinage  
Chamfering fonction
- ▶ Fonction feuillure 12 mm  
12 mm Rabbet fonction
- ▶ Réglage par molette crantée (tous les 0,2 mm)  
Adjustement by notched knob (every 0,2 mm)

Livré avec guide parallèle, de feuillure, sac à poussières et un jeu de lames réversibles  
Supplied with parallel guide, rabbet, dust bag and a set of reversible blades



**EJECTION**  
Copeaux

Rabot électrique - Electric planer

EP 850

Gencode

**3431541154933**

Puissance du moteur - Motor power (230V-50Hz)

**850 W**

Variateur de vitesse électronique - Electronic variable speed

**16500 min<sup>-1</sup>**

Capacité de coupe dans le bois - Wood cutting capacity

**82 x 3 mm**

Données logistiques - Logistic informations



Box 610x360x370 mm | Master 6 x 3,8 kg | Pal 96 | Ctr 20ft 2070 pcs

Consommables - Consumables

2 Lames 82x6x1,25 mm - Blades

**3431541158733**

DÉCAPAGE  
STRIPPING

ÉLECTROPORATIF  
HANDPOWER TOOLS

X-FIT  
RANGE

ATELIER  
WORKSHOP

BOIS  
WOOD MACHINES

MÉTAL  
METAL MACHINES

NETTOYAGE  
CLEANING

MÉTIERS  
MANUAL WORK

JARDIN FILAIRE  
GARDEN TOOLS

Plus d'info sur  
**far.tools.com**

# Lamelleuse - Biscuit jointer - LM 900B

0/18 mm  
760 Watts



- ▶ **Changement de lame facile**  
Easy blade replacement
- ▶ **Machine précise : tête métal**  
Precise machine: metal head
- ▶ **Réglage de l'inclinaison de 0 à 90°**  
Tilting base from 0 to 90°
- ▶ **Réglage de la hauteur de 0 à 40 mm**  
High adjustment from 0 to 40 mm
- ▶ **Réalisation d'empreintes et de rainurage horizontal et vertical de 0 à 45°**  
Making impressions and horizontal or vertical slots from 0 to 45°
- ▶ **Semelle de glisse amovible pour le rainurage**  
Movable slip pad for cutting

Livrée avec sac de récupération des poussières et semelle de glisse  
Delivered with dust recovery bag and slipping pad

YouTube



Lamelleuse - Biscuit jointer	LM 900B
Gencode	3431541150089
Puissance du moteur - Motor power (230V-50Hz)	760 W
Vitesse de rotation - Rotation speed	11600 min <sup>-1</sup>
Dimensions du disque - Disc sizes	100x22x4 mm
Course du guide parallèle - Cutting capacity	0 - 40 mm
Profondeur de coupe - Depth cutting	0 - 18 mm
Données logistiques - Logistic informations	
3 431541 150089   Box 780x440x270 mm   Master 4 x 5,75 kg   Pal 60   Ctr 20ft 1200 pcs	
Consommables - Consumables	
Lame - Blade	3431541158306

# Chevillouse tourilloneuse - Dual spindle doweling jointer - CT 710

ø 8 mm  
710 Watts



- ▶ **Profondeur de perçage réglable de 0 à 40 mm**  
Adjustable drilling depth 0 to 40 mm
- ▶ **Tête aluminium**  
Aluminium head
- ▶ **Guide de perçage de précision entièrement réglable (0° à 90°)**  
Fully adjustable precision drill guide (0° to 90°)
- ▶ **Perçages possibles ø 6 / 8 / 10 mm**  
Drilling ø 6 / 8 / 10 mm
- ▶ **Perçage simultané de mortaises pour chevilles entraxe 32 mm**  
Simultaneous drilling of dowel mortises center distance 32 mm
- ▶ **Réglage de la hauteur de perçage par système de crémaillère**  
Drilling height adjustment by rack system

Livrée avec deux forets ø 8 mm, deux clés allen  
Supplied with two drill bits ø 8 mm, two allen keys

YouTube



Chevillouse tourilloneuse - Dual spindle doweling jointer		CT 710
Gencode		<b>3431541150072</b>
Puissance du moteur - Motor power (230V-50Hz)		<b>710 W</b>
Vitesse de rotation - Rotation speed		<b>16500 min<sup>-1</sup></b>
Diamètre de perçages - Drilling sizes		<b>ø 8 mm</b>
Entraxe - Center distance		<b>32 mm</b>
Données logistiques - Logistic informations		
3 431541 150072   Box 397x166x240 mm   Master 4x20 kg   Pal 60 pcs   Ctr 20ft 1480 pcs		
Consommables - Consumables		
6 forets pour tourilloneuse ø 6/8/10 mm - 6 drill bits		<b>343154115798</b>

DÉCAPAGE  
STRIPPING

ÉLECTROPORATIF  
HANDPOWER TOOLS

X-FIT  
RANGE

ATELIER  
WORKSHOP

BOIS  
WOOD MACHINES

MÉTAL  
METAL MACHINES

NETTOYAGE  
CLEANING

MÉTIER  
MANUAL WORK

JARDIN FILAIRE  
GARDEN TOOLS

Plus d'info sur  
**far**tools.com

# Affleureuse - Edge router - AE 850

Ø 6 / 8 mm  
850 Watts



- ▶ **Carter de protection**  
Protective housing
- ▶ **Changement facile de profondeur**  
Easy depth change
- ▶ **Mandrin Ø 6 / 8 mm**  
6 / 8 mm chuck
- ▶ **Variateur de vitesse électronique**  
Electronic variable speed

Livré avec un guide de coupe parallèle et 2 clés de serrage  
Delivered with a parallel cutting guide and 2 keys



**SPEED**  
Control

**YouTube**



Affleureuse - Edge router	AE 850
Gencode	3431541154001
Puissance du moteur - Motor power (230V-50Hz)	850 W
Variateur de vitesse électronique - Electronic variable speed	10000 - 30000 min <sup>-1</sup>
Capacité de coupe dans le bois - Wood cutting capacity	40 mm maxi
Dimensions du mandrin - Chuck sizes	Ø 6 / 8 mm
Données logistiques - Logistic informations	
Box 70x320x240 mm   Master 8x16,8 kg   Pal 80 pcs   Ctr 20ft 6480 pcs	
Consommables - Consumables	
Jeu de 12 fraises Ø 8 - Cutters set	3431541158047

# Défonceuse - Router - ER 1300

ø 8/12 mm  
1300 Watts



**PRODUIT MALIN**  
SMART PRODUCT

ADAPTEUR POUR ASPIRATEUR  
ADAPTER FOR VACUUM CLEANER

ø 40 mm  
ø 35,6 mm  
ø 32,4 mm  
ø 26,5 mm

3431541018518

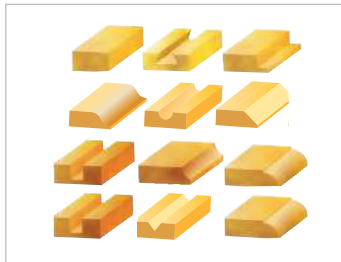

Raccordement à un aspirateur  
Connection to a vacuum cleaner

- ▶ **Ajustement micrométrique : travail précis**  
Micrometric adjustment: precise work
- ▶ **Raccordement à un aspirateur**  
Vacuum cleaner connection
- ▶ **Carter et soufflets de protection**  
Housing and bellows
- ▶ **Variateur de vitesse électronique**  
Electronic variable speed
- ▶ **LED d'éclairage pour un confort visuel en milieu obscur**  
LED Lighting for a better work in dark areas

*Livrée avec 6 fraises, guide parallèle à réglage micrométrique, guide de coupe circulaire, connecteur pour aspiration, 2 mandrins*  
*Delivered with 6 milling cutters, parallel guide with micrometric adjustment, circular cutting guide, suction connector, 2 mandrels*



**Arbor Lock**



**LED Light**



**SPEED Control**

Défonceuse - Router	ER 1300
Gencode	<b>3431541154704</b>
Puissance du moteur - Motor power (230V-50Hz)	<b>1300 W</b>
Variateur de vitesse électronique - Electronic variable speed	<b>11000 - 28000 min<sup>-1</sup></b>
Capacité de coupe dans le bois - Wood cutting capacity	<b>55 mm maxi</b>
Dimensions du mandrin - Chuck sizes	<b>ø 8 / 12 mm</b>

Données logistiques - Logistic informations

Box 670x300x380 mm   Master 4 x 5,1 kg   Pal 60   Ctr 20ft 1440 pcs	
Consommables - Consumables	
Jeu de 12 fraises Ø 8 - Cutters set	<b>3431541158047</b>

DÉCAPAGE  
STRIPPING

ÉLECTROPORATIF  
HANDPOWER TOOLS

X-FIT  
RANGE

ATELIER  
WORKSHOP

BOIS  
WOOD MACHINES

MÉTAL  
METAL MACHINES

NETTOYAGE  
CLEANING

MÉTIERS  
MANUAL WORK

JARDIN FILAIRE  
GARDEN TOOLS

Plus d'info sur  
**fartools.com**

# Scie circulaire sur rail - Circular saw on rail - CS 85R

ø 85 mm  
500 Watts



- ▶ **Multimatériaux : lame pour le bois, le PVC, le métal et la céramique**  
Multipurposes : blade for wood, PVC, metal and ceramic
- ▶ **Blocage d'arbre**  
Arbor lock
- ▶ **Variateur de vitesse électronique**  
Electronic variable speed
- ▶ **Système de plongée de lame progressive et calibrée**  
Progressive and calibrated blade dive system



Livrée avec 3 lames (bois, métal, PVC et céramique) et rail 0,70 m avec étaux de fixation  
Delivered with 3 blades (wood, PVC, metal and ceramic) and 0,70 m rail with vices



**RUBBER**  
Grip



**Dust**  
Collector



**INCLINABLE**  
Tilting



**Bois, métal, plastique et matériaux**  
Wood, metal, plastic and materials

Scie circulaire sur rail - Circular saw on rail		CS 85R
Gencode		<b>3431541154469</b>
Puissance du moteur - Motor power (230V-50Hz)		<b>500 W</b>
Vitesse de rotation - Rotation speed		<b>3600 - 6500 min<sup>-1</sup></b>
Diamètre / alésage de la lame - Blade diameter / bore		<b>85 / 15 (3,15") mm</b>
Nombre de dents - Teeth number		<b>Bois : 24 T / Métal : 44 T</b>
Capacité de coupe dans le bois / métal - Wood / metal cutting capacity		<b>22 / 2 mm</b>
Données logistiques - Logistic informations		
 Box 100x125x375 mm   Master 2 x 2,1 kg   Pal 144   Ctr 20ft 6400 pcs 3 431541 154469		
Consommables - Consumables		
3 disques Bois, Alu, Métal et carrelage - Set of 3 discs all materials		<b>3431541158450</b>

Utilisable sans le rail  
Usable without the rail

# Scie circulaire sur rail - Circular saw on rail - CS 165RC

ø 165 mm  
1200 Watts



- ▶ Butée réglable et maintien de la lame plongeante  
Adjustable stop and holding the plunging blade
- ▶ Carter de protection ULTRA FIN Aluminium  
ULTRA THIN Aluminium Guard
- ▶ Poignée anti-vibrations  
Anti-vibration handle
- ▶ Collecteur de poussières orientable  
Orientable dust collector
- ▶ Base inclinable 0-45°  
0-45° Tilting base
- ▶ Profondeur réglable  
Depth adjustment

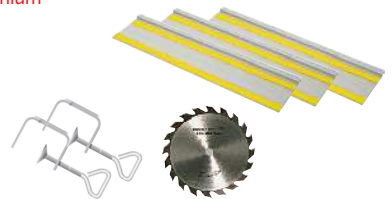

Livrée avec rail de guidage 1,65 m, 1 lame carbure 48 T montée, 2 étaux de fixation  
Delivered with 1,65 m guidance rail, 1 carbide blade 48 T mounted, 2 vices



Inclinable 0-45°  
0-45° Tilting blade



Scie circulaire sur rail - Circular saw on rail		CS 165RC
Gencode	3431541154438	
Puissance du moteur - Motor power (230V-50Hz)	1200 W	
Vitesse de rotation - Rotation speed	5200 min <sup>-1</sup>	
Diamètre / alésage de la lame - Blade diameter / bore	ø 165 / 20 mm	
Nombre de dents - Teeth number	48 T	
Capacité de coupe dans le bois - Wood cutting capacity	90° = 55 mm	
Base inclinable - Tilting blade	0-45°	

#### Données logistiques - Logistic informations



Box 755x333x280 mm | Master 2 x 6,0 kg | Pal 30 | Ctr 20ft 816 pcs

#### Consommables - Consumables

Lame 48T - 48T blade 3431541139671

DÉCAPAGE  
STRIPPING

ÉLECTROPORATIF  
HANDPOWER TOOLS

X-FIT  
RANGE

ATELIER  
WORKSHOP

BOIS  
WOOD MACHINES

MÉTAL  
METAL MACHINES

NETTOYAGE  
CLEANING

MÉTIER  
MANUAL WORK

JARDIN FILAIRE  
GARDEN TOOLS

Plus d'info sur  
**fartools.com**



# Scie circulaire - Circular saw - LL 1400F

ø 185 mm  
1300 Watts



**PRODUIT MALIN**  
SMART PRODUCT

ADAPTEUR POUR ASPIRATEUR  
ADAPTER FOR VACUUM CLEANER

ø 40 mm  
ø 35,6 mm  
ø 32,4 mm  
ø 26,5 mm

3431541018518



EXISTE AUSSI EN  
VERSION BATTERIE  
ALSO AVAILABLE IN  
BATTERY VERSION

18 V  
Battery System

**X-FIT**

XF-circular - 216005 - P 114



Visée laser  
Laser target



Base inclinable / profondeur réglable  
Tilting base / adjustable depth

- ▶ Visée laser sur piles  
Laser target on batteries
- ▶ Base ALUMINIUM  
ALUMINIUM base
- ▶ Blocage d'arbre  
Arbor lock
- ▶ Collecteur de poussières  
Dust collector
- ▶ Base inclinable / profondeur réglable  
Tilting base / adjustable depth

Livrée avec lame 36 dents démontée, guide parallèle, clé, 2 piles et collecteur de poussières  
Delivered with unmounted 36 T blade, parallel guide, wrench, 2 batteries and dust connector



**LASER**  
Target



**INCLINABLE**  
Tilting



**DUST**  
Collector



**RUBBER**  
Grip

Scie circulaire - Circular saw		LL 1400F
	Gencode	<b>3431541154360</b>
Puissance du moteur - Motor power (230V-50Hz)		1300 W
Diamètre / alésage de la lame - Blade diameter / bore		185 / 20 (7,2") mm
Nombre de dents - Teeth number		36 T
Vitesse de rotation - Rotation speed		4500 tr.min <sup>-1</sup>
Capacité de coupe dans le bois Wood cutting capacities		90° = 63 mm 45° = 42 mm
Données logistiques - Logistic informations		
Box 340x250x185 mm   Master 4 x 4,75 kg   Pal 48   Ctr 20ft 1532 pcs		
Consommables - Consumables		
Lame 24T - 24T blade		<b>3431541158320</b>
Lame 40T - 40T blade		<b>3431541158344</b>

# Scie circulaire - Circular saw - CS 235

ø 235 mm  
2000 Watts



«Coupe de poutres  
100x120 DOUGLAS:  
rapide, précise  
et efficace.»  
Wilfried Z.

**PRODUIT MALIN**  
SMART PRODUCT

ADAPTATEUR POUR ASPIRATEUR  
ADAPTER FOR VACUUM CLEANER

ø 40 mm  
ø 35,6 mm  
ø 32,4 mm  
ø 26,5 mm

3431541018518



Grande capacité  
High capacity



Accès rapide aux charbons  
Fast access to carbon brushes

- ▶ **Blocage d'arbre**  
Arbor lock
- ▶ **Grande capacité de coupe** : 90° = 85 mm | 45° = 60 mm  
Large cutting capacity: 90° = 85 mm | 45° = 60 mm
- ▶ **Base Aluminium inclinable / profondeur de coupe réglable**  
Tilting aluminium base / depth of cut adjustment
- ▶ **Encoches pour coupe à 45 ou 90°**  
Notches for 45 or 90° cuts

Livrée avec guide de coupe parallèle, une clé et une lame 40 dents montée  
Delivered with parallel guide, one key and his own 40T blade mounted



**SPEED**  
Control



**RUBBER**  
Grip

Scie circulaire - Circular saw

CS 235

Gencode	<b>3431541154421</b>
Puissance du moteur - Motor power (230V-50Hz)	2000 W
Diamètre / alésage de la lame - Blade diameter / bore	235 / 25,4 (9,2") mm
Nombre de dents - Teeth number	36 T
Vitesse de rotation - Rotation speed	4500 tr.min <sup>-1</sup>
Capacité de coupe dans le bois - Wood cutting capacities	90° = 85 mm 45° = 60 mm
Base inclinable - Tilting blade	OK

Données logistiques - Logistic informations



3 4315411154421

Box 415x285x290 mm | Master 2 x 8,1 kg | Pal 36 | Ctr 20ft 1000 pcs

Consommables - Consumables

Lame 48T - 48T blade

3431541158481

DÉCAPAGE  
STRIPPING

ÉLECTROPORATIF  
HANDPOWER TOOLS

X-FIT  
RANGE

ATELIER  
WORKSHOP

BOIS  
WOOD MACHINES

MÉTAL  
METAL MACHINES

NETTOYAGE  
CLEANING

MÉTIERS  
MANUAL WORK

JARDIN FILAIRE  
GARDEN TOOLS

Plus d'info sur  
**fartools.com**

# Scie circulaire double lame - Double blade circular saw - SDBL-125

Ø 125 mm  
1050 W



«La double lame permet de couper le métal, le bois et le plastique.»  
Benoit B.



Double lame  
Double blade

- ▶ **Multi-matériaux : coupe le bois, le métal et le plastique**  
Multimaterials : cut the wood, metal and plastic
- ▶ Coupe droite sans éclat  
Straight cut without sparkles
- ▶ Collecteur de poussières, connectable à un aspirateur  
Dust collector, connectable to a vacuum cleaner
- ▶ Poignée ergonomique  
Ergonomic handle
- ▶ Fonction lubrification pour le métal  
Lubrication function for metal cutting
- ▶ Blocage d'arbre  
Arbor lock

Livrée en mallette avec 10 sticks de graisse  
Delivered in bmc with 10 grease sticks



Découpe multi-matériaux  
Multi materials cuts



**Bois, métal et plastique**  
Wood, metal and plastic



**RUBBER**  
Grip



Scie circulaire double lame - Double blade circular saw		SDBL-125
Gencode		<b>3431541154476</b>
Puissance du moteur - Motor power (230V-50Hz)		<b>1050 W</b>
Diamètre / alésage de la lame - Blade diameter / bore		<b>Ø 125 / 22 mm</b>
Nombre de dents - Teeth number		<b>32 T</b>
Vitesse de rotation - Rotation speed		<b>5500 min<sup>-1</sup></b>
Capacité de coupe dans le bois / métal Wood / Metal cutting capacities		<b>22 / 2,5 mm</b>
Blocage d'arbre - Arbor lock		<b>OK</b>
Données logistiques - Logistic informations		
Box 410x100x255 mm   Master 4 x 2,87 kg   Pal 144   Ctr 20ft 1260 pcs		
Données de référence - Reference data		
3 431541 154476		
Consommables - Consumables		
10 Sticks de graisse - 10 grease sticks		<b>3431541158283</b>
2 Lames Ø 125 mm, 32T - Ø 125 mm, 32T blades		<b>3431541158290</b>

# Grignoteuse à tôle - Nibbler - GT 600B

360°  
600 Watts

EXISTE AUSSI EN  
VERSION BATTERIE  
ALSO AVAILABLE IN  
BATTERY VERSION

ECO  
ACTION



18 V  
Battery System  
**X-FIT**

XF-nibbler - 216022 - P 112

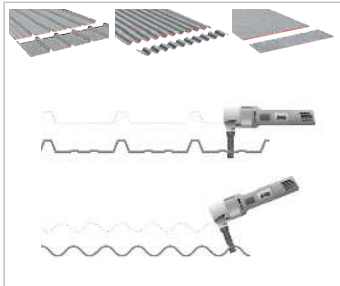

Tête de coupe 4 positions : 0, 90, 90, 180  
4 positions cutting head: 0, 90, 90, 180

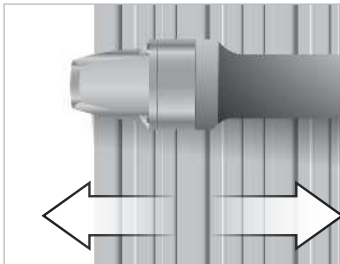
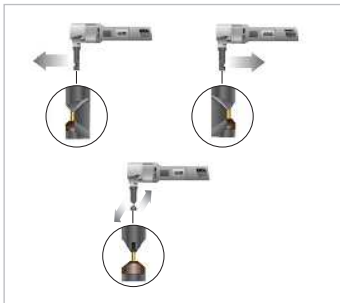

Découpe arrière /avant  
Back / front cutting



- ▶ Pour découpe de métaux ferreux et non ferreux, tôles et profilés  
For cutting ferrous and non ferrous, metal sheets and profiles
- ▶ Permet de suivre facilement et précisément un tracé ou un gabarit  
Easily follow and precise cutting
- ▶ Coupe précise en ligne comme en courbe  
Precise cutting line as curve
- ▶ Protection de la main en métal  
Metallic protection guard
- ▶ Tête de coupe réglable à 360°  
360° adjustable head
- ▶ Tête aluminium  
Aluminium head

Livrée avec un poinçon supplémentaire  
Delivered with an additional punch



**INOX**  
Stainless steel  
1,2 mm



**ACIER**  
Steel  
1,8 mm



**ALUMINIUM**  
Aluminium  
2,5 mm

YouTube



Grignoteuse à tôle - Nibbler	GT 600B
Gencode	3431541150805
Puissance du moteur - Motor power (230V~50Hz)	600 W
Cadence de coupe maximale - Maximum cutting speed	2000 / min
Épaisseur de coupe maximale - Maximum cutting thickness	2 mm
Données logistiques - Logistic informations	
3 431541 150805   Box 300x200x130 mm   Master 5 x 3,5 kg   Pal 120   Ctr 20ft 3800 pcs	
Consommables - Consumables	
Jeu de 2 poinçons - Set of 2 punches	3431541150843

DÉCAPAGE  
STRIPPING

ÉLECTROPORATIF  
HANDPOWER TOOLS

X-FIT  
RANGE

ATELIER  
WORKSHOP

BOIS  
WOOD MACHINES

MÉTAL  
METAL MACHINES

NETTOYAGE  
CLEANING

MÉTIER  
MANUAL WORK

JARDIN FILAIRE  
GARDEN TOOLS

Plus d'info sur  
fartools.com

Maxi 65 mm  
570 Watts



Éjection rapide de la lame  
Rapid ejection of the blade

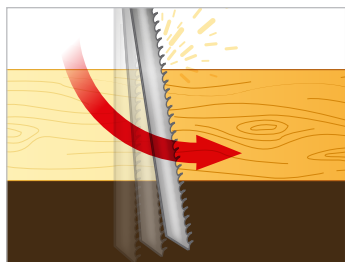

Fonction pendulaire  
Pendular function

- ▶ **Légère et maniable**  
Light and handy
- ▶ **Changement de lame rapide sans outils**  
Keyless quick blade change
- ▶ **Système pendulaire 3 positions**  
Pendular system 3 positions
- ▶ **Variateur de vitesse électronique**  
Electronic variable speed
- ▶ **Base inclinable de 0° à 45°**  
Tilting base 0° to 45°



Livrée avec 3 lames, guide parallèle et connecteur pour aspiration  
Delivered with 3 blades, parallel guide and dust connector



**SPEED**  
Control



**RUBBER**  
Grip



**Dust**  
Collector

Scie sauteuse - Jig saw	JS 570C
Gencode	<b>3431541154803</b>
Puissance du moteur - Motor power (230V-50Hz)	<b>570 W</b>
Variateur de vitesse électronique - Electronic variable speed	<b>800 - 2800 hit.min<sup>-1</sup></b>
Capacité de coupe dans le bois - Wood cutting capacity	<b>65 mm</b>
Capacité de coupe dans le fer - Steel cutting capacity	<b>8 mm</b>
Système pendulaire / Type de lame - Pendular system / Blade type	<b>OK / T type</b>
Base inclinable - Tilting blade	<b>0-45° (+/-)</b>
<b>Données logistiques - Logistic informations</b>	



Box 340x275x235 mm | Master 4 x 2,30 kg | Pal 264 | Ctr 20ft 5200 pcs

# Scie sauteuse - Jig saw - JS 800R

Maxi 80 mm  
800 Watts

EXISTE AUSSI EN  
VERSION BATTERIE  
ALSO AVAILABLE IN  
BATTERY VERSION



XF-Jlg - 216009 - P 113



- ▶ **Patin de glisse**  
Sliding pad
- ▶ **Système de souffleur de poussières : précision de coupe**  
Dust blower system: cutting accuracy
- ▶ **Laser auto-alimenté**  
Laser on transformer
- ▶ **Système pendulaire 3 positions**  
Pendular system 3 positions
- ▶ **Variateur de vitesse électronique**  
Electronic variable speed
- ▶ **Base inclinable de 0° à 45° + patin de glisse**  
Tilting base 0° to 45° + sliding base
- ▶ **Changement de lame rapide sans outils**  
Keyless quick blade change



Livrée avec 3 lames, guide parallèle et connecteur pour aspiration  
Delivered with 3 blades, parallel guide and dust connector



**LASER**  
Target



**SPEED**  
Control



**RUBBER**  
Grip



**Dust**  
Collector

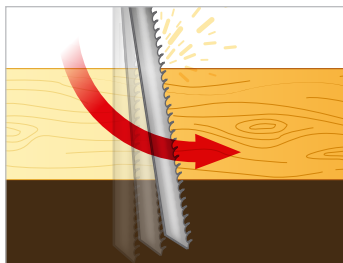

Fonction pendulaire  
Pendular function

Scie sauteuse - Jig saw	JS 800R
Gencode	<b>3431541154551</b>
Puissance du moteur - Motor power (230V-50Hz)	<b>800 W</b>
Variateur de vitesse électronique - Electronic variable speed	<b>800 - 3000 hit.min<sup>-1</sup></b>
Capacité de coupe dans le bois - Wood cutting capacity	<b>80 mm</b>
Capacité de coupe dans le fer - Steel cutting capacity	<b>10 mm</b>
Système pendulaire / Type de lame - Pendular system / Blade type	<b>OK / T type</b>
Base inclinable - Tilting blade	<b>0-45° (+/-)</b>

Données logistiques - Logistic informations



3 431541 1154551

Box 335x300x240 mm | Master 4 x 2,80 kg | Pal 192 | Ctr 20ft 2200 pcs

DÉCAPAGE  
STRIPPING

ÉLECTROPORATIF  
HANDPOWER TOOLS

X-FIT  
RANGE

ATELIER  
WORKSHOP

BOIS  
WOOD MACHINES

MÉTAL  
METAL MACHINES

NETTOYAGE  
CLEANING

MÉTIERS  
MANUAL WORK

JARDIN FLAIRE  
GARDEN TOOLS

Plus d'info sur  
**far**tools.com

# Scie sauteuse - Jig saw - JS 730C

Maxi 100 mm  
750 Watts

**NOUVEAU**

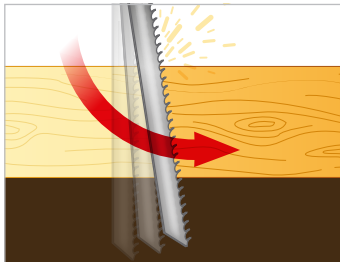

Fonction pendulaire  
Pendular function



- ▶ **Fonction souffleur de poussière sur lame**  
Dust blower on blade function
- ▶ **Eclairage par LED**  
LED Lighting
- ▶ **Système pendulaire 3 positions**  
Pendular system 3 positions
- ▶ **Variateur de vitesse électronique**  
Electronic variable speed
- ▶ **Base inclinable de 0° à 45° + patin de glisse**  
Tilting base 0° to 45° + sliding base
- ▶ **Changement de lame rapide sans outils**  
Keyless quick blade change
- ▶ **Poignée confort anti-dérapante**  
Comfort non-slip handle



Livrée avec 4 lames (bois, métal), collecteur de poussières et guide parallèle  
Delivered with 4 blades (wood, metal), dust collector and parallel guide



**LASER**  
Target



**LED**  
Light



**SPEED**  
Control



**RUBBER**  
Grip



**Dust**  
Collector

Scie sauteuse - Jig saw		JS 730C
	Gencode	<b>3431541153004</b>
Puissance du moteur - Motor power (230V-50Hz)		<b>750 W</b>
Variateur de vitesse électronique - Electronic variable speed		<b>0 - 3000 hit.min<sup>-1</sup></b>
Capacité de coupe dans le bois - Wood cutting capacity		<b>100 mm</b>
Capacité de coupe dans le fer - Steel cutting capacity		<b>10 mm</b>
Système pendulaire / Type de lame - Pendular system / Blade type		<b>OK / T type</b>
Base inclinable - Tilting blade		<b>0-45° (+/-)</b>

Données logistiques - Logistic informations



3 431541 1153004

Box 320x186x85 mm | Master 6 x 2,45 kg | Pal 180 | Ctr 20ft 5082 pcs

# Scie électrique - Electrical saw - RS 350

60 mm  
350 Watts



- ▶ **Changement rapide de lame sans outil**  
Keyless quick changing blade
- ▶ **4 Lames = multi-matériaux**  
4 Blades = multimaterials
- ▶ **Variateur de vitesse électronique**  
Electronic variable speed
- ▶ **Ergonomique**  
Ergonomic
- ▶ **Grande capacité : 60 mm**  
High capacity: 60 mm

*Livrée avec 4 lames : bois / métal / plâtre / carrelage*  
*Delivered with 4 blades : wood / metal / plaster / floor tiles*



**RUBBER**  
Grip



**SPEED**  
Control

Scie électrique - Electrical saw		<b>RS 350</b>
	Gencode	<b>3431541154483</b>
Puissance du moteur - Motor power (230V-50Hz)		350 W
Variateur de vitesse électronique - Electronic variable speed		<b>0 - 2350 min<sup>-1</sup></b>
Capacité de coupe dans le bois - Wood cutting capacity		<b>60 mm</b>
Capacité de coupe dans le fer - Steel cutting capacity		<b>6 mm</b>
Données logistiques - Logistic informations		
3  431541154483   Box 185x70x370 mm   Master 10 x 2,0 kg   Pal 180   Ctr 20ft 5090 pcs		
Consommables - Consumables		
4 lames - 4 blades		<b>3431541157996</b>

DÉCAPAGE  
STRIPPING

ÉLECTROPORATIF  
HANDPOWER TOOLS

X-FIT  
RANGE

ATELIER  
WORKSHOP

BOIS  
WOOD MACHINES

MÉTAL  
METAL MACHINES

NETTOYAGE  
CLEANING

MÉTIERS  
MANUAL WORK

JARDIN FILAIRE  
GARDEN TOOLS

Plus d'info sur  
**fartools.com**



# Scie sabre - Reciprocating saw - RS 800B

Maxi 115 mm  
750 Watts

EXISTE AUSSI EN  
VERSION BATTERIE  
ALSO AVAILABLE IN  
BATTERY VERSION



XF-Saw - 216006 - P 115



**NOUVEAU**

**3**  
positions  
indexées

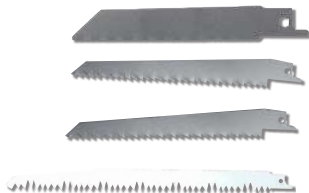

Butée de longueur réglable  
Adjustable depth gauge



Tête rotative +/- 90°  
+/- 90° Rotative head

- ▶ Tête rotative à +/- 90°  
Rotative head from 0 to +/- 90°
- ▶ Changement rapide de lame sans outil  
Keyless quick changing blade
- ▶ Variateur de vitesse électronique  
Electronic variable speed
- ▶ Protection isolante et anti-glisse  
Insulating and anti slip rubber coating
- ▶ Butée de longueur réglable  
Adjustable depth gauge

Livrée avec lame pour le métal 150 mm 18 TPI, lame métal 150mm 24TPI, lame bois 150 mm et lame de tronçonnage bois 240 mm.

Supplied with a blade for metal 18 TPI 150 mm, a metal blade 24TPI 150mm, a timber 150 mm blade and cutting blade wood 240 mm.



**SPEED**  
Control



**RUBBER**  
Grip



**Universal**  
Universel

Scie sabre - Reciprocating saw

RS 800B

Gencode

**3431541154544**

Puissance du moteur - Motor power (230V-50Hz)

**750 W**

Variateur de vitesse électronique - Electronic variable speed

**0 - 2800 hit.min<sup>-1</sup>**

Capacité de coupe dans le bois - Wood cutting capacity

**115 mm**

Capacité de coupe dans le fer - Steel cutting capacity

**8 mm**

Tête rotative - Rotative head

**OK / 90° (+/-)**

Données logistiques - Logistic informations



3 431541 1154544

Box 490x310x450 mm | Master 6 x 3,15 kg | Pal 102 | Ctr 20ft 2436 pcs

## PRODUIT MALIN SMART PRODUCT

COFFRET MINI OUTILLAGE  
MINI TOOL BOX



167 pcs 3431541158443



- ▶ **Légère**  
Light
- ▶ **Efficace et précise**  
Efficient and precise
- ▶ **Blocage d'arbre**  
Arbor lock
- ▶ **Variateur de vitesse électronique**  
Electronic variable speed
- ▶ **Crochet pour suspendre la machine**  
Hook for hanging the machine

*Livrée sous blister*  
Delivered under blister



Spécial pour loisirs créatifs  
Perfect for hobbies



**SPEED**  
Control

Mini meuleuse - Mini grinder

DC 170

Gencode **3431541154247**

Puissance du moteur - Motor power (230V~50Hz)

**170 W**

Variateur de vitesse électronique - Electronic variable speed

**8000 - 35000 min<sup>-1</sup>**

Données logistiques - Logistic informations



Box 340x280x450 mm | Master 8 x 0,8 kg | Pal 192 | Ctr 20ft 5120 pcs

Consommables - Consumables

Gamme de mini outillage - Mini tools range (p 75)



- ▶ **Poignée de maintien, pour un travail plus précis**  
Holding handle, for a more precision work
- ▶ **Blocage d'arbre**  
Arbor lock
- ▶ **Variateur de vitesse électronique**  
Electronic variable speed
- ▶ **Crochet pour suspendre la machine**  
Hook for hanging the machine

*Livrée en mallette, avec poignée de précision, 126 accessoires, étau, flexible et guide de coupe*  
Delivered in a case, with precision grip, 126 accessories, vice, flexible and cutting guide



**SPEED**  
Control

Mini meuleuse - Mini grinder	DCP 170
Gencode	<b>3431541154261</b>
Puissance du moteur - Motor power (230V~50Hz)	<b>170 W</b>
Variateur de vitesse électronique - Electronic variable speed	<b>8000 - 35000 min<sup>-1</sup></b>
Données logistiques - Logistic informations	
	
Box 370x285x98 mm   Master 6 x 2,0 kg   Pal 96   Ctr 20ft 2700 pcs	
Consommables - Consumables	
Gamme de mini outillage - Mini tools range (p 75)	

Spécial pour loisirs créatifs  
Perfect for hobbies

# Outil multi-fonctions - Multi purpose tool - DM 220B

**Oscillation 3°**  
300 Watts

EXISTE AUSSI EN  
VERSION BATTERIE  
ALSO AVAILABLE IN  
BATTERY VERSION



XF-tools - 216003 - P 109



A80 / A120 / A240



- ▶ Outils offrant une oscillation de 3°  
Tools with an oscillation of 3°
- ▶ Corps fin : bonne prise en main  
Thin body: good grip
- ▶ Variateur de vitesse électronique  
Electronic variable speed

Livré avec 2 spatules, 1 patin de ponçage et 3 papiers abrasifs  
Delivered with 2 spatula, 1 sanding pad and 3 abrasive papers



**RUBBER**  
Grip



**OSCILLA-  
TION**



**SPEED**  
Control

Outil multi-fonctions - Multi purpose tool

DM 220B

Gencode

3431541151444

Puissance du moteur - Motor power (230V~50Hz)

300 W

Variateur de vitesse électronique - Electronic variable speed

11000 - 23000 min<sup>-1</sup>

Oscillation - Oscillation

3 °

Données logistiques - Logistic informations



3 431541 1151444

Box 470x345x250 mm | Master 5 x 2,4 kg | Pal 112 | Ctr 20ft 3240 pcs

DÉCAPAGE  
STRIPPING

ÉLECTROPORATIF  
HANDPOWER TOOLS

X-FIT  
RANGE

ATELIER  
WORKSHOP

BOIS  
WOOD MACHINES

MÉTAL  
METAL MACHINES

NETTOYAGE  
CLEANING

MÉTIERS  
MANUAL WORK

JARDIN FILAIRE  
GARDEN TOOLS

Plus d'info sur  
**far**tools.com

**PRODUIT MALIN**  
SMART PRODUCT

ADAPTEUR POUR ASPIRATEUR  
ADAPTER FOR VACUUM CLEANER

ø 40 mm  
ø 35,6 mm  
ø 32,4 mm  
ø 26,5 mm

3431541018518



- ▶ **Changement rapide des accessoires**  
Quick-change accessories
- ▶ **Poignée gaucher / droitier**  
Left / right handle
- ▶ **Tête en aluminium**  
Aluminum head
- ▶ **Corps fin : bonne prise en main**  
Thin body; good grip
- ▶ **Variateur de vitesse**  
Speed variator
- ▶ **Collecteur de poussières à la base de l'outil**  
Dust collector at blade level



Livré en sac tissu avec 3 spatules, 1 patin de ponçage et 4 papiers abrasifs  
Delivered in fabric bag with 3 spatula, 1 sanding pad and 4 abrasive papers



**RUBBER**  
Grip

Outil multi-fonctions - Multi purpose tool	DM 300
Gencode	<b>3431541151451</b>
Puissance du moteur - Motor power (230V-50Hz)	<b>300 W</b>
Vitesse de rotation - Rotation speed	<b>15000-22000 tr.min<sup>-1</sup></b>
Nombre de positions poignée - Handle positions number	<b>x 2</b>
Données logistiques - Logistic informations	



Box 470x34,5x250 mm | Master 5 x 2,3 kg | Pal 230 | Ctr 20ft 3240 pcs



Différents outils – différents usages - DC 130, DC 170, DCP 170, MGB 120

Different tools – different uses - DC 130, DC 170, DCP 170, MGB 120



3431541158412

Métal  
Metal



3431541158429

Bois  
Wood



3431541158436

Porcelaine / verre  
Porcelain / Glass



3431541158443

Plastique  
Plastic



DÉCAPAGE  
STRIPPING

ÉLECTROPORATIF  
HANDPOWER TOOLS

X-FIT  
RANGE

ATELIER  
WORKSHOP

BOIS  
WOOD MACHINES

MÉTAL  
METAL MACHINES

NETTOYAGE  
CLEANING

MÉTIER  
MANUAL WORK

JARDIN FLEURE  
GARDEN TOOLS

Plus d'info sur  
fartools.com

# Outil de sculpture sur bois - Wood carving tool - SB 50B

50 Watts



- ▶ **Tête en aluminium : travail en continu**  
Aluminum head : continuous work
- ▶ **Changement rapide des accessoires**  
Quick-change accessories
- ▶ **Pour réaliser toutes sortes de travaux de précision**  
To make all kinds of precision work
- ▶ **Travail adapté à toutes les essences de bois**  
Work adapted to all species of wood

*Livré avec 3 accessoires : 1 ciseau en V (6 mm), 1 ciseau en U (9 mm) et un ciseau droit (9 mm)  
Delivered with 3 accessories: V-shaped chisel (6 mm), 1 U-shaped chisel (9 mm) and a straight chisel (9 mm)*



Outil de sculpture sur bois - Wood carving tool	<b>SB 50B</b>
Gencode	<b>3431541154285</b>
Puissance du moteur - Motor power (230V-50Hz)	<b>50 W</b>
Vitesse de frappe - Striking rate	<b>11000 tr.min<sup>-1</sup></b>
Accessoires - Accessories	<b>x 3</b>
Données logistiques - Logistic informations	
3  Box 400x300x230 mm   Master 5 x 1 kg   Pal 230   Ctr 20ft 5250 pcs	
Consommables - Consumables	
3 accessoires à sculpter - 3 accessories to carve	<b>3431541154292</b>

# Pyrograveur - Pyrographer - PB 30

30 Watts

**NOUVEAU**



Nombreux outils et gabarits  
Many tools and templates

- **Nombreux embouts interchangeables : pour tous types de travaux**  
Numerous interchangeable tips: for all types of work
- **Changement rapide des accessoires**  
Quick-change accessories
- **Deux puissances de travail = 15 W & 30 W**  
Two working power settings = 15 W & 30 W
- **Pour réaliser toutes sortes de travaux de décoration**  
To make all kinds of decoration work
- **Travail adapté à toutes les essences de bois**  
Work adapted to all species of wood

Livré en coffret avec 22 accessoires : 1 support, 1 gabarit et 20 embouts  
Supplied in a box with 22 accessories: 1 support, 1 template and 20 tips

Pyrograveur - Pyrographer	PB 30
Gencode	3431541154117
Puissance - Power (230V-50Hz)	15 / 30 W
Accessoires - Accessories	x 22

Données logistiques - Logistic informations



Box 400x300x230 mm | Master 5 x 1 kg | Pal 230 | Ctr 20ft 5250 pcs



DÉCAPAGE  
STRIPPING

ÉLECTROPORATIF  
HANDPOWER TOOLS

X-FIT  
RANGE

ATELIER  
WORKSHOP

BOIS  
WOOD MACHINES

MÉTAL  
METAL MACHINES

NETTOYAGE  
CLEANING

MÉTIER  
MANUAL WORK

JARDIN FILAIRE  
GARDEN TOOLS

Plus d'info sur  
**fartools.com**



# Découpeuse à fil chaud - Electric cutting tool - HW 96

9,6 Watts



- ▶ **3 en 1 : fil chaud pour découpe, couteau pour ébauche, outil de gravure**  
3 in 1: hot wire for cutting, roughing knife, engraving tool
- ▶ **Grande précision**  
Very accurate
- ▶ **Pour polystyrène expansé**  
Expanded polystyrene
- ▶ **Changement rapide des accessoires**  
Quick-change accessories

Livrée avec 2 accessoires (perçage et écriture) et fil de rechange  
Supplied with 2 accessories (drilling and writing) and spare wire



Découpeuse à fil chaud - Electric cutting tool

HW 96

Gencode **3431541154278**

Puissance - Power (230V-50Hz)

**9,6 W**

Température de chauffe - Temperature of heating

**185° C**

Données logistiques - Logistic informations



Box 360x120x30 mm | Master 20 x 0,4 kg | Pal 520 | Ctr 20ft 12000 pcs

# Table de découpe à fil chaud - Hot wire cutting table - HWCT 32

32 Watts

**NOUVEAU**

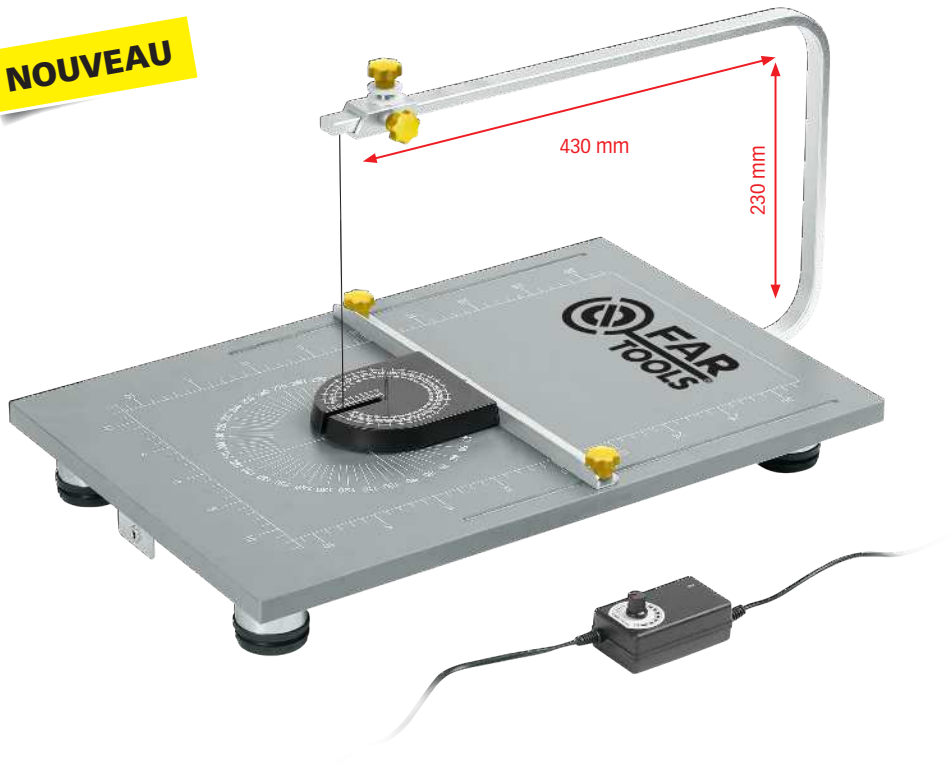

Pointe compas, pour coupes circulaires  
Compass tip, for circular cuts

- ▶ **Température de fil réglable, pour s'adapter aux matériaux et aux épaisseurs**  
Adjustable wire temperature, to adapt to materials and thicknesses
- ▶ **Buté parallèle réglable**  
Adjustable parallel stop
- ▶ **Pour polystyrène expansé, mousse polyéther et polyéthylène**  
For expanded polystyrene, polyether foam and polyethylene
- ▶ **Guide compas, pour exécuter des découpes circulaires parfaites**  
Compass guide, to make perfect circular cuts

Livrée avec fil de rechange  
Supplied with spare wire

Table de découpe à fil chaud - Electric cutting table		HWCT 32
Gencode	3431541154124	
Puissance - Power (230V~50Hz)	32 W	
Capacités de coupe - Cutting capacities	240 x 420 mm	
Dimensions de table - Table sizes	360 x 540 mm	
ø du fil - Wire diameter	ø 0,2 mm	
Température de chauffe - Temperature of heating	350° C	
Données logistiques - Logistic informations		
 3 431541 1154124		
Box 360x120x30 mm   Master 20 x 0,4 kg   Pal 520   Ctr 20ft 12000 pcs		
Consommables - Consumables		
Bobine de fil de 5 m - 5 m of wire	3431541154143	

DÉCAPAGE  
STRIPPING

ÉLECTROPORATIF  
HANDPOWER TOOLS

X-FIT  
RANGE

ATELIER  
WORKSHOP

BOIS  
WOOD MACHINES

MÉTAL  
METAL MACHINES

NETTOYAGE  
CLEANING

MÉTIER  
MANUAL WORK

JARDIN FILAIRE  
GARDEN TOOLS

Plus d'info sur  
**fartools.com**

# Fer à souder avec support - Soldering iron with stand - SI 30

30 Watts

**NOUVEAU**



- ▶ **Pour travaux de soudage fin : électronique, modélisme**  
For wire welding work: electrical, model making
- ▶ **Grande précision**  
Very accurate
- ▶ **Petites pinces crocodiles, pour le maintien des pièces à souder**  
Small crocodile clips, for holding parts to be welded
- ▶ **Trappe de rangement des accessoires**  
Accessory storage hatch

Livrée avec 1 panne pointue, 1 panne plate, 20 grammes d'étain, éponge de nettoyage  
Supplied with 1 pointed tip, 1 flat tip, 20 grams of tin, cleaning sponge

Fer à souder avec support- Soldering iron with stand	SI 30
Gencode	3431541154100
Puissance - Power (230V-50Hz)	30 W
Température de chauffe - Temperature of heating	185° C
Données logistiques - Logistic informations	



Box 360x120x30 mm | Master 20 x 0,4 kg | Pal 520 | Ctr 20ft 12000 pcs

# Décolleuse papier peint - Steam wallpaper remover - DV 5LB

4,8 L  
2100 Watts

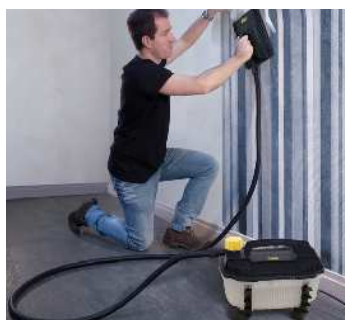

« Sécurité manque d'eau »  
« Security lack of water »

- ▶ **Soupape de sûreté**  
Safety valve
- ▶ « Sécurité manque d'eau » : protection automatique par coupure électrique en cas de niveau bas d'eau  
« Security lack of water »: automatic protection in case of power failure low water level
- ▶ **Cuve de 4,8 litres**  
Tank of 4,8 liters
- ▶ **Roulettes de transport, déplacement facile**  
Transport wheels, easy movement

*Livrée avec tube flexible de 3 m et roulettes de transport*  
*Delivered with 3 m flexible and transport casters*



x 4

Décolleuse papier peint - Steam wallpaper remover		DV 5LB
Gencode		<b>3431541155268</b>
Puissance du moteur - Motor power (230V-50Hz)		<b>2100 W</b>
Volume de la cuve - Tank volume		<b>4,8 L</b>
Longueur du tuyau - Hose length		<b>3 m</b>
Dimensions du plateau - Plate sizes		<b>275 x 195 mm</b>
Données logistiques - Logistic informations		



3 431541 1155268

Box 305x255x310 mm | Master 4 x 2,8 kg | Pal 50 | Ctr 20ft 1016 pcs

DÉCAPAGE  
STRIPPING

ÉLECTROPORATIF  
HANDPOWER TOOLS

X-FIT  
RANGE

ATELIER  
WORKSHOP

BOIS  
WOOD MACHINES

MÉTAL  
METAL MACHINES

NETTOYAGE  
CLEANING

MÉTIERS  
MANUAL WORK

JARDIN FILAIRE  
GARDEN TOOLS

Plus d'info sur  
**fartools.com**

# Pistolet à air chaud - Hot air gun - HG 2000C

50 - 600°C

2000 Watts

**NOUVEAU**

EXISTE AUSSI EN  
VERSION BATTERIE  
ALSO AVAILABLE IN  
BATTERY VERSION



XF-heatergun - 216029 - P 111



- ▶ Thermostat de chauffe réglable de 50° à 600° C  
Heat thermostat, adjustable from 50° to 600° C
- ▶ 2 Vitesses de ventilation :  
2 fan speeds :  
V1=300 L/min  
V2=500 L/min

Livré avec 5 accessoires  
Delivered with 5 accessories



Allures de chauffe ajustables  
Heat adjustable settings



Jusqu'à 600 °C  
Up to 600 °C

Pistolet à air chaud - Hot air gun	HG 2000C
Gencode	3431541153547
Puissance du moteur - Motor power (230V~50Hz)	2000 W
Allures de chauffe ajustables - Heat adjustable settings	50 - 600 °C
Vitesses de ventilation Fan speeds	V1 = 300 L/min V2 = 500 L/min
Thermostat de chauffe - Heat thermostat	OK

Données logistiques - Logistic informations



Box 520x280x480 mm | Master 10 x 0,95 kg | Pal 240 | Ctr 20ft 4100 pcs

# Pistolet à air chaud - Hot air gun - DT 2000B

50 - 600°C  
2000 Watts

**NOUVEAU**

EXISTE AUSSI EN  
VERSION BATTERIE  
ALSO AVAILABLE IN  
BATTERY VERSION



XF-heatergun - 216029 - P 111



Température ajustable  
Adjustable temperature

- ▶ **Thermostat et ventilation :**  
réglables et précis  
Thermostat and ventilation:  
adjustable and precise
- ▶ **3 allures de chauffe :**  
3 heating speeds:  
V<sub>1</sub> = 50 °C  
V<sub>2</sub> = 50 - 350 °C  
V<sub>3</sub> = 70 - 600 °C

Livré avec 6 accessoires  
Delivered with 6 accessories



Pistolet à air chaud - Hot air gun	DT 2000B
Gencode	3431541153394
Puissance du moteur - Motor power (230V-50Hz)	2000 W
Allures de chauffe ajustables Heat adjustable settings	V1 = 50 °C V2 = 50 - 350 °C V3 = 70 - 600 °C
Vitesses de ventilation Fan speeds	V1=V2=250 L/min V3=500 L/min
Thermostat de chauffe - Heat thermostat	OK

Données logistiques - Logistic informations



3 431541 1153394

Box 350x100x291 mm | Master 4 x 2,5 kg | Pal 120 | Ctr 20ft 2300 pcs

DÉCAPAGE  
STRIPPING

ÉLECTROPORATIF  
HANDPOWER TOOLS

X-FIT  
RANGE

ATELIER  
WORKSHOP

BOIS  
WOOD MACHINES

MÉTAL  
METAL MACHINES

NETTOYAGE  
CLEANING

MÉTIERS  
MANUAL WORK

JARDIN FILAIRE  
GARDEN TOOLS

Plus d'info sur  
fartools.com

# Polisseuse lustreuse - Polisher - PL 225

ø 240 mm  
120 Watts



- ▶ Livrée avec une éponge + un bonnet de polissage  
Delivered with 1 sponge + 1 polishing cap
- ▶ Large poignée ergonomique  
Ergonomic broad handle

*Livrée avec une bonnette et une éponge*  
Delivered with a polishing buff and 1 sponge



Multiples applications  
Multiple applications



Grand confort  
Comfortable work

Polisseuse - Polisher	PL 225
Gencode	3431541150232
Puissance du moteur - Motor power (230V-50Hz)	120 W
Vitesse de rotation - Speed	3200 min <sup>-1</sup>
Dimension du disque - Disc sizes	ø 240 mm
Données logistiques - Logistic informations	



3 431541 150232

Box 300x270x270 mm | Master 4 x 2,75 kg | Pal 80 | Ctr 20ft 1592 pcs

# Polisseuse - Polisher - PO 180D

ø 180 mm  
1200 Watts



- ▶ **Variateur de vitesse électronique**  
Electronic variable speed
- ▶ **Répartition optimale du poids pour un grand confort**  
Optimal weight distribution for comfort
- ▶ **Large poignée ergonomique**  
Ergonomic broad handle
- ▶ **Blocage d'arbre**  
Arbor lock

*Livrée avec une bonnette et une éponge*  
Delivered with a polishing buff and 1 sponge



Variateur de vitesse électronique  
Electronic variable speed



Grand confort  
Comfortable work

Polisseuse - Polisher	<b>PO 180D</b>
Gencode	<b>3431541150263</b>
Puissance du moteur - Motor power (230V-50Hz)	<b>1200 W</b>
Variateur de vitesse électronique - Electronic variable speed	<b>0 - 4800 min<sup>-1</sup></b>
Dimension du disque - Disc sizes	<b>ø 180 mm</b>
Diamètre de l'arbre - Arbor diameter	<b>M14</b>
Données logistiques - Logistic informations	
Box 570x360x280 mm   Master 2 x 5,65 kg   Pal 40   Ctr 20ft 1150 pcs	
Consommables - Consumables	
Bonnette - Polishing buff	<b>3431541158269</b>
Eponge ronde ø180 mm - Round 180 mm sponge	<b>3431541158276</b>

DÉCAPAGE  
STRIPPING

ÉLECTROPORATIF  
HANDPOWER TOOLS

X-FIT  
RANGE

ATELIER  
WORKSHOP

BOIS  
WOOD MACHINES

MÉTAL  
METAL MACHINES

NETTOYAGE  
CLEANING

MÉTIERS  
MANUAL WORK

JARDIN FILAIRE  
GARDEN TOOLS

Plus d'info sur  
**fartools.com**



EXISTE AUSSI EN  
VERSION BATTERIE  
ALSO AVAILABLE IN  
BATTERY VERSION



XF-stapler - 216023 - P 110



Agrafes :  
T 53  
Maxi. 12 mm



Clous :  
T 47  
Maxi. 10 mm

**2i1**



- ▶ **2 fonctions : agrafeuse et cloueuse**  
2 functions: stapler & nailer
- ▶ Indicateur de charge  
Charge indicator
- ▶ Capteur de pression : sécurité de contact  
Pressure sensor: contact safety
- ▶ Chargeur rapide agrafe / clou en métal  
Quick charger staple / metal nail
- ▶ Poignée ergonomique  
Ergonomic handle
- ▶ Embout de chargement micro USB  
Micro USB charging nozzle



Livrée avec 1000 agrafes type 53 / 12 mm et 500 clous type 47 / 10 mm  
Delivered with 1000 staples type 53 / 12 mm & 500 nails type 47 / 10 mm



Embout de chargement micro USB  
Micro USB charging nozzle

Agrafeuse cloueuse sans fil - Cordless stapler / nailer	SN 36
Gencode	3431541154223
Tension et puissance de la batterie - Battery voltage and power	3,6 V - 1,5 Ah
Temps de charge indicatif - Indicative charge time	3 - 5 h
Vitesse de frappe - Striking rate	30 cps.min <sup>-1</sup>
Dimensions clou - Nail size	10 mm
Dimensions agrafe - Staple size	12 mm
Données logistiques - Logistic informations	



Box 335x270x265 mm | Master 4 x 2,25 kg | Pal 192 | Ctr 20ft 4475 pcs

## Disques diamant - Diamond discs



	Ref.	 A x B x C x D mm		Pour - Feets on
CLASSIC CUT LASER	3431541190214	150 X 22,2 X 7 X 2 mm	SEGMENTS LASER CLASSIQUES. QUALITÉ "MAÇON". CLASSIC LASER SEGMENTED. « BUILDER » QUALITY.	115441
CARLA'O HQ	3431541191358	230 X 22,2 X 5 X 1,6 mm	COUPE DÉLICATE À EAU POUR MEULEUSES D'ANGLES. ADDITION DE COBALT POUR VITESSE ET QUALITÉ DE COUPE. ACCRUES - DRY DELICATE CUT FOR ANGLE GRINDERS. COBALT ADDITION FOR AN IMPROVED CUTTING SPEED AND QUALITY	115077
CARLA'O HQ COBALT	3431541190580	180 X 22,2 X 5 X 1,6 mm		113500 / 113540
CARLA'O	3431541191501	180 X 22,2 X 5,4 X 2,4 mm		115028
	3431541158894	125 X 22,2 X 21,5 mm	PONÇAGE ET SURFAÇAGE DU BÉTON SANDING AND SURFACING CONCRETE	115032

## Tableau de préconisation - Diamond discs recommendations

	à eau - Water (*) à sec - Dry (-)	Type de jante Ring type*	Diamètres disponibles Available diameters (ø mm)	Matériaux Fragiles Fragile Materials	Matériaux Materials	Matériaux Armés Reinforced Material	Carrelage, Marbre Tiles - Marble	Profilé acier Profiled steel
				Brique, tuile, ardoise Brick, Roofing tile, slate	béton, pavé, dalle Concrete, Paving, Slab	Béton armé Reinforced Concrete		
Flash cut laser	• / -	S	230	☺ ☺ ☺	☺ ☺ ☺	☺ ☺ ☺	☺	
Classic cut Laser	• / -	S	115 125 150 230	☺	☺ ☺ ☺	☺		
Classic Turbo	• / -	T	115 125 230	☺ ☺	☺		☺	
Carla'sec HQ	-	C	115 125	☺			☺	
Polydiam	-	S	230	☺	☺ ☺ ☺	☺ ☺ ☺	☺	☺ ☺ ☺

\*  Jante continue  
Continuous ring  
Llanta continua  
Jante continua

 Jante crénelée / Turbo ring  
Llanta dentada / Orlo turbo  
Jante com ameias / Kantelen

 S



	Ref.	 A x B x C mm			
TRONÇONNAGE - DOORSLIJPEN TRENEN - TAGLIO CUTTING CORTAR EN TROZOS - CORTAR	3431541190917	350 x 25,4 x 3 mm	***	***	INOX
DISQUES PLATS VLAKKE SCHIJVEN PIRRETTI FLAT DISCS - DISCOS PLANOS DISCOS PLANOS					
STATIONNAIRE - STATIONAR STATIONARY ESCACIONARIO ESTACIONARIAS					
			Acier plein - Massief staal Vollstahl - Acciaio pieno Full steel - Acero lleno Ferro total	Acier fin - Fijn staal Dünner Stahl Fino acciaio Acero fino Acciaio fine - Aço fino	

# L'univers **X-FIT**

X-FIT tools

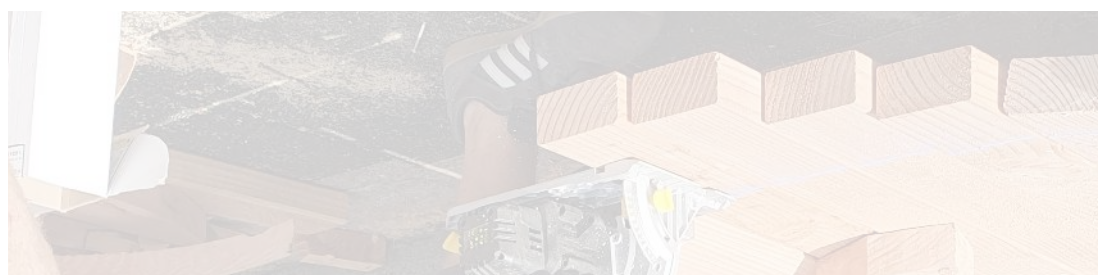

DÉCAPAGE  
STRIPPING

ÉLECTROPORATIF  
HANDPOWER TOOLS

X-FIT  
RANGE

ATELIER  
WORKSHOP

BOIS  
WOOD MACHINES

MÉTAL  
METAL MACHINES

NETTOYAGE  
CLEANING

MÉTIER  
MANUAL WORK

JARDIN FILAIRE  
GARDEN TOOLS

Plus d'info sur  
**fartools.com**

# UNE BATTERIE UNIQUE

1,5 AH / 3,0 AH



XFB-Grinder



XF-Grinder



XF-Delta



XF-Orbital



XF-Plaster



XFB-Wrench



XF-Drill



XF-Impact



XFB-Impact



XF-Hammer



XF-Light



XF-Jig



XF-Circular



# POUR TOUTES VOS MACHINES

4,0 AH / 5,0 AH



XF-Heatergun



XF-Comp



XF-Saw2



XF-Stapler



XF-Vacuum



XF-Ashes



XF-Tools



XF-Planer



XF-Nibbler



XF-Brush

**3** ANS  
GARANTIE

\* Hors batteries (1 an)

DÉCAPAGE  
STRIPPING

ÉLECTROPORTATIF  
HANDPOWER TOOLS

X-FIT  
RANGE

ATELIER  
WORKSHOP

BOIS  
WOOD MACHINES

MÉTAL  
METAL MACHINES

NETTOYAGE  
CLEANING

MÉTIER  
MANUAL WORK

JARDIN FILAIRE  
GARDEN TOOLS

Plus d'info sur  
[fartools.com](http://fartools.com)

De la

# 3D

dans votre magasin

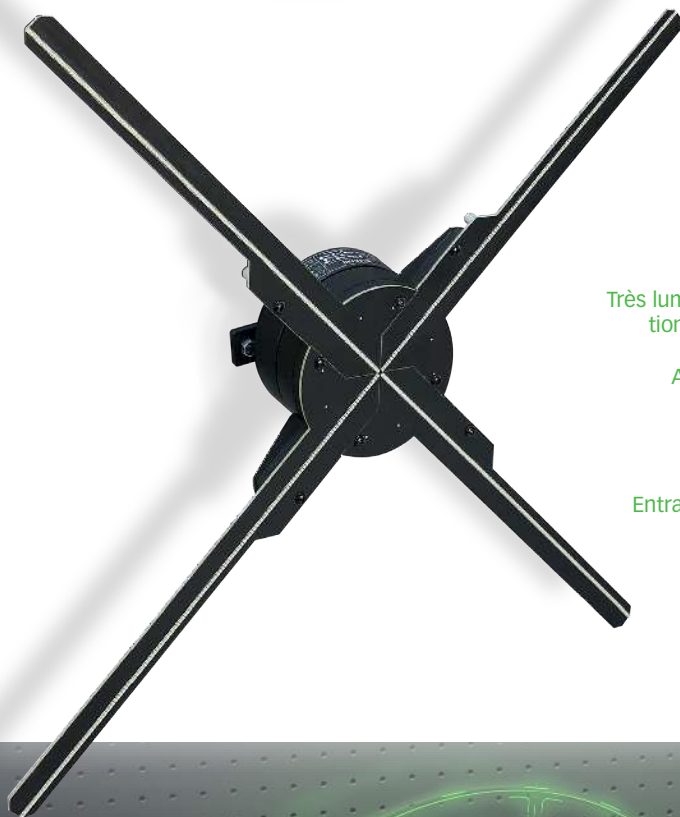

Animez votre rayon X-FIT avec l'**hélice holographique** ! Très lumineuse et avec une haute résolution, elle attirera inévitablement l'œil des clients dans votre magasin. Adaptable sur tous supports grâce à ses pattes de fixation.

Diamètre de l'hélice : **520 mm**  
Profondeur : **64 mm**  
Entraxe de fixation horizontal : **86 mm**



# Batterie unique pour toutes vos machines ! De 1,5 à 5,0 Ah

**1** Sélectionnez votre batterie de départ  
1,5 - 4,0 ou 5 Ah...



**MOTEUR SANS CHARBON  
BRUSHLESS MOTOR**

Les produits X-FIT BRUSHLESS utilisent une technologie de moteur sans charbon qui offre :

- Jusqu'à 50 % de performance en plus !
- Une puissance accrue jusqu'à 30 %
- 4 fois plus de longévité du produit
- Et aussi : un poids et un encombrement réduits, une faible consommation électrique, peu d'échauffement moteur, un fort couple au démarrage, un niveau sonore réduit, etc...

DÉCAPAGE  
STRIPPING

ÉLECTROPORATIF  
HANDPOWER TOOLS

X-FIT  
RANGE

ATELIER  
WORKSHOP

BOIS  
WOOD MACHINES

MÉTAL  
METAL MACHINES

NETTOYAGE  
CLEANING

MÉTIERS  
MANUAL WORK

JARDIN FILAIRE  
GARDEN TOOLS

Plus d'info sur  
**fartools.com**



«La garantie du Service Après Vente»  
Sans les contraintes

LE **NOUVEAU** SERVICE, Click & Change de FARTOOLS, permet **au client** de recevoir sous 72 h\* machines et/ou batteries neuves **à son adresse**.

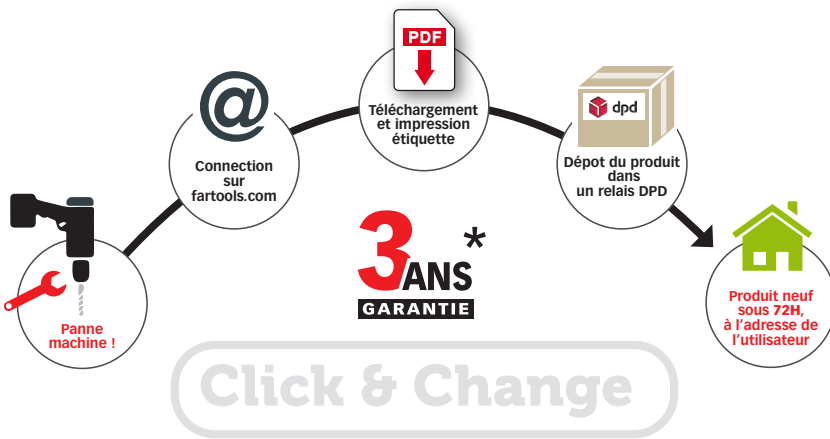

### UN VRAI SERVICE CLIENT...

- Gratuit pour l'utilisateur
- Sans pré-inscription
- Pas besoin de ticket de caisse ou de facture
- Simple et rapide :  
Service de re-livraison en 72 h\*
- Un grand réseau de livraison
- Transport et livraison = Service PREMIUM

### ... ET UN VRAI BÉNÉFICE POUR LES MAGASINS !

- Gestion automatisée entre l'utilisateur et FARTOOLS
- Aucun traitement SAV pour le magasin
- Expertise des retours pour amélioration du taux SAV

### Le réseau **dpd Pickup** c'est :

- Plus de **5000 relais** en France,
- 95% de la population à **moins de 15 min** d'un relais Pickup,
- Relais ouvert 6 Jours par semaine de moyenne,  
**100% ouvert le samedi**.



\* - 72 heures à compter de la date du dépôt en relais colis  
- Service valable uniquement en France métropolitaine et en Corse  
- Dans la limite de la garantie des produits soit 3 ans (hors batteries 1 AN)  
- Valable uniquement sur la gamme X-FIT



# Perceuse sans fil - Cordless drill - XF-Drill2

**18 V**  
30 Nm



**30** Une batterie unique pour **MACHINES**



- ▶ 19+1 Réglages de couple 30 Nm  
19+1 Torque adjustments 30 Nm
- ▶ Mandrin ø 10 mm  
ø 10 mm chuck
- ▶ 2 Vitesses mécaniques  
2 mechanical speeds
- ▶ Clip ceinture  
Belt clip

Livrée avec 2 batteries 1.5 Ah, chargeur rapide et accessoires  
Delivered with 2 x 1.5 Ah batteries, fast charger and accessories



**STOP**  
10 mm



**LED**  
Light



**SPEED**  
Control



**RUBBER**  
Grip



**REVERSE**  
Reversible



**2 Speeds**  
2 Vitesses



## Perceuse visseuse - Cordless drill

	<b>XF-Drill2</b>
Gencode	<b>3431542160001</b>
Tension et puissance de la batterie - Battery voltage and power	<b>18 V</b>
Kit batterie / chargeur Battery / charger kit	<b>2 batteries 1.5 Ah &amp; chargeur</b> 2 batteries 1.5 Ah & charger
Temps de charge indicatif - Indicative charge time	<b>40 min</b>
Variateur de vitesse électronique - Electronic variable speed	<b>0-350 / 0-1300 min<sup>-1</sup></b>
Réglage de couple - Torque settings	<b>x 19   30 Nm</b>
Mandrin - Chuck	<b>ø 10 mm</b>

Données logistiques - Logistic informations

Box 240x120x340 mm | Master 4x3,4 kg | Pal 96 | Ctr 20ft 5600 pcs



3 431542 160001

### Consommables - Consumables

XF-Bat 15 : Batterie 1.5 Ah - Battery 1.5 Ah	<b>3431542160155</b>
XF-Bat 40 : Batterie 4.0 Ah - Battery 4.0 Ah	<b>3431542160162</b>
XF-Bat 50 : Batterie 5.0 Ah - Battery 5.0 Ah	<b>3431542160193</b>
XF-Kit 15 : Batterie 1.5 Ah & chargeur rapide - Battery 1.5 Ah & charger	<b>3431542160179</b>
XF-Kit 15 : Batterie 4.0 Ah & chargeur rapide - Battery 4.0 Ah & charger	<b>3431542160185</b>
XF-Kit 15 : Batterie 5.0 Ah & chargeur rapide - Battery 5.0 Ah & charger	<b>3431542160358</b>

DÉCAPAGE  
STRIPPING

ÉLECTROPORTATIF  
HANDPOWER TOOLS

X-FIT  
RANGE

ATELIER  
WORKSHOP

BOIS  
WOOD MACHINES

MÉTAL  
METAL MACHINES

NETTOYAGE  
CLEANING

MÉTIERS  
MANUAL WORK

JARDIN FILAIRE  
GARDEN TOOLS

Plus d'info sur  
**fartools.com**

# Perceuse visseuse percussion - Cordless impact drill - XF-Impact2

18 V  
40 Nm



**30** Une batterie unique pour **MACHINES**



LED d'éclairage  
LED Lighting



Clip ceinture  
Belt clip

- ▶ Fonction percussion 0-27000 cps/min  
Impact function 0-27000 hit/min
- ▶ 19+3 Réglages de couple 40 Nm  
19+3 Torque adjustments 40 Nm
- ▶ Mandrin ø 13 mm auto-serrant  
ø 13 mm single sleeve chuck and automatic spindle lock
- ▶ 2 Vitesses mécaniques  
2 mechanical speeds
- ▶ Clip ceinture  
Belt clip

Livrée en mallette avec 2 batteries 3.0 Ah et chargeur rapide  
Delivered in bmc with 2 batteries 3.0 Ah and fast charger



## Perceuse visseuse sans fil percussion - Cordless impact drill

	XF-Impact2
Gencode	<b>3431542160018</b>
Tension et puissance de la batterie - Battery voltage and power	<b>18 V</b>
Kit batterie / chargeur Battery / charger kit	<b>2 batteries 3.0 Ah &amp; chargeur</b> 2 batteries 3.0 Ah & charger
Temps de charge indicatif - Indicative charge time	<b>80 min</b>
Variateur de vitesse électronique - Electronic variable speed	<b>0-500 / 0-1800 min<sup>-1</sup></b>

### Données logistiques - Logistic informations

Box 300x127x375 mm | Master 5x4,75 kg | Pal 70 | Ctr 20ft 5600 pcs



3 431542 160018

### Consommables - Consumables

XF-Bat 15 : Batterie 1.5 Ah - Battery 1.5 Ah	3431542160155
XF-Bat 40 : Batterie 4.0 Ah - Battery 4.0 Ah	3431542160162
XF-Bat 50 : Batterie 5.0 Ah - Battery 5.0 Ah	3431542160193
XF-Kit 15 : Batterie 1.5 Ah & chargeur rapide - Battery 1.5 Ah & charger	3431542160179
XF-Kit 15 : Batterie 4.0 Ah & chargeur rapide - Battery 4.0 Ah & charger	3431542160185
XF-Kit 15 : Batterie 5.0 Ah & chargeur rapide - Battery 5.0 Ah & charger	3431542160358

# Perceuse visseuse percussion - Cordless impact drill - XFC-Impact2

18 V  
45 Nm



**30** Une batterie unique pour **MACHINES**



Moteur BRUSHLESS  
BRUSHLESS Motor

- ▶ 19+3 réglages de couple 45 N/m  
19+3 Torque adjustments 45 N/m
- ▶ Mandrin ø 13 mm auto-serrant  
ø 13 mm single sleeve chuck and automatic spindle lock
- ▶ 2 Vitesses mécaniques  
2 mechanical speeds
- ▶ Vissage-dévisage  
Screw-unscrew
- ▶ Fonction percussion : 0-28800 cps/min  
Percussion function: 0-28800 hit. min<sup>-1</sup>
- ▶ Clip ceinture  
Belt clip

Livrée en mallette avec 2 batteries 3.0 Ah, chargeur rapide et 13 accessoires  
Delivered in BMC with 2 x 3.0 Ah batteries, fast charger and 13 accessories

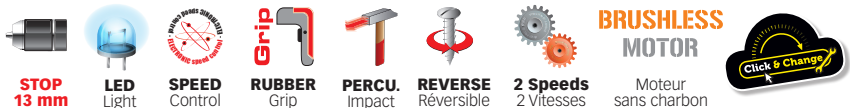

## Perceuse visseuse sans fil percussion - Cordless impact drill

	<b>XFC-Impact2</b>
Gencode	<b>3431542160100</b>
Tension et puissance de la batterie - Battery voltage and power	<b>18 V</b>
Kit batterie / chargeur Battery / charger kit	<b>2 batteries 3.0 Ah &amp; chargeur</b> 2 batteries 3.0 Ah & charger
Temps de charge indicatif - Indicative charge time	<b>80 min</b>
Variateur de vitesse électronique - Electronic variable speed	<b>0-500 / 0-1800 min<sup>-1</sup></b>

### Données logistiques - Logistic informations

Box 300x127x380 mm | Master 5x4,75 kg | Pal 60 | Ctr 20ft 1470 pcs



### Consommables - Consumables

XF-Bat 15 : Batterie 1.5 Ah - Battery 1.5 Ah	3431542160155
XF-Bat 40 : Batterie 4.0 Ah - Battery 4.0 Ah	3431542160162
XF-Bat 50 : Batterie 5.0 Ah - Battery 5.0 Ah	3431542160193
XF-Kit 15 : Batterie 1.5 Ah & chargeur rapide - Battery 1.5 Ah & charger	3431542160179
XF-Kit 15 : Batterie 4.0 Ah & chargeur rapide - Battery 4.0 Ah & charger	3431542160185
XF-Kit 15 : Batterie 5.0 Ah & chargeur rapide - Battery 5.0 Ah & charger	3431542160358

DÉCAPAGE  
STRIPPING

ÉLECTROPORTATIF  
HANDPOWER TOOLS

X-FIT  
RANGE

ATELIER  
WORKSHOP

BOIS  
WOOD MACHINES

MÉTAL  
METAL MACHINES

NETTOYAGE  
CLEANING

MÉTIER  
MANUAL WORK

JARDIN FILAIRE  
GARDEN TOOLS

Plus d'info sur  
**fartools.com**

# Visseuse à choc sans fil - Cordless impact driver - XF-Wrench

18 V  
150 Nm



**30** Une batterie unique pour  
**MACHINES**



Ideale pour les grandes vis  
Usefull for big screws

- ▶ **Couple 150 Nm**  
Torque 150 Nm
  - ▶ **Fonction percussion : 0-3000 cps/min**  
Impact function: 0-3000 hit/min
  - ▶ **Vissage-dévisage**  
Screw-unscrew
  - ▶ **Clip ceinture**  
Belt clip
  - ▶ **Type d'emmanchement 1/4" avec déverrouillage rapide**  
1/4" chuck with quick unlock
- Livrée avec 4 douilles : ø 6, 8, 10, 12 mm  
Delivered with 4 sockets: ø 6, 8, 10, 12 mm



**LED**  
Light



**SPEED**  
Control



**RUBBER**  
Grip



**PERCU.**  
Impact



**REVERSE**  
Réversible



Visseuse à choc sans fil - Cordless impact driver	XF-Wrench	KIT XF-Wrench
Gencode	<b>3431542160360</b>	<b>3431546162360</b>
Tension et puissance de la batterie - Battery voltage and power	<b>18 V</b>	<b>18 V - 1.5Ah</b>
Kit batterie / chargeur Battery / charger kit	<b>Sans batterie ni chargeur</b> Without battery nor charger	<b>1 batterie 1.5 Ah &amp; chargeur</b> 1.5 Battery & charger
Temps de charge indicatif - Indicative charge time	-	<b>40 min</b>
Variateur de vitesse électronique - Electronic variable speed	<b>0-2000 min<sup>-1</sup></b>	<b>0-2000 min<sup>-1</sup></b>
Fonction percussion - Impact function	<b>0-3000 cps.min<sup>-1</sup></b>	<b>0-3000 hit.min<sup>-1</sup></b>
Réglage de couple - Torque settings	<b>150 Nm</b>	<b>150 Nm</b>

Données logistiques - Logistic informations

Box 220x105x205 mm | Master 10 x 15,0 kg | Pal 180 | Ctr 20ft 1536 pcs



Consommables - Consumables

XF-Bat 15 : Batterie 1.5 Ah - Battery 1.5 Ah	<b>3431542160155</b>	<b>3431542160155</b>
XF-Bat 40 : Batterie 4.0 Ah - Battery 4.0 Ah	<b>3431542160162</b>	<b>3431542160162</b>
XF-Bat 50 : Batterie 5.0 Ah - Battery 5.0 Ah	<b>3431542160193</b>	<b>3431542160193</b>
XF-Kit 15 : Batterie 1.5 Ah & chargeur rapide - Battery 1.5 Ah & charger	<b>3431542160179</b>	<b>3431542160179</b>
XF-Kit 15 : Batterie 4.0 Ah & chargeur rapide - Battery 4.0 Ah & charger	<b>3431542160185</b>	<b>3431542160185</b>
XF-Kit 15 : Batterie 5.0 Ah & chargeur rapide - Battery 5.0 Ah & charger	<b>3431542160353</b>	<b>3431542160353</b>

# Marteau perforateur SDS - SDS Rotary hammer - XF-Hammer

18 V  
1,2 J



30 Une batterie unique pour  
MACHINES



Butée de profondeur  
Depth gauge

- ▶ Force 1,2 J - 5000 cps/min  
Power 1,2 J - 5000 hit/min
  - ▶ 2 Vitesses mécaniques  
2 Mechanical speeds
  - ▶ Vissage-dévisage  
Screw-unscrew
  - ▶ Variateur de vitesse électronique  
Electronic variable speed
  - ▶ Poignée orientable 360° avec butée de profondeur  
360° Rotative handle with depth gauge
- Livré avec 3 forets, 3 burins SDS et porte-embouts  
Delivered with 3 drills, 3 chisels and bit holder



SDS



SPEED  
Control



RUBBER  
Grip



PERCU.  
Impact



REVERSE  
Réversible



2 Speeds  
2 Vitesses



Marteau perforateur SDS - SDS Rotary hammer

XF-Hammer

KIT XF-Hammer

Gencode

3431542160025

3431546162025

Tension et puissance de la batterie - Battery voltage and power

18 V

18 V - 4.0 Ah

Kit batterie / chargeur

Battery / charger kit

Sans batterie ni chargeur  
Without battery nor charger

1 batterie 4.0 Ah & chargeur  
4.0 Battery & charger

Temps de charge indicatif - Indicative charge time

-

100 min

Variateur de vitesse électronique - Electronic variable speed

0-300 / 0-1000 min<sup>-1</sup>

0-300 / 0-1000 min<sup>-1</sup>

Fonction percussion - Impact function

0-5000 cps.min<sup>-1</sup>

0-5000 hit.min<sup>-1</sup>

Force - Power

1,2 Joules

1,2 Joules

Données logistiques - Logistic informations

Box 210x100x320 mm | Master 2 x 3,0 kg | Pal 132 | Ctr 20ft 3114 pcs



3 431542 160025



3 431546 162025

Consommables - Consumables

XF-Bat 15 : Batterie 1.5 Ah - Battery 1.5 Ah	3431542160155	3431542160155
XF-Bat 40 : Batterie 4.0 Ah - Battery 4.0 Ah	3431542160162	3431542160162
XF-Bat 50 : Batterie 5.0 Ah - Battery 5.0 Ah	3431542160193	3431542160193
XF-Kit 15 : Batterie 1.5 Ah & chargeur rapide - Battery 1.5 Ah & charger	3431542160179	3431542160179
XF-Kit 15 : Batterie 4.0 Ah & chargeur rapide - Battery 4.0 Ah & charger	3431542160185	3431542160185
XF-Kit 15 : Batterie 5.0 Ah & chargeur rapide - Battery 5.0 Ah & charger	3431542160353	3431542160353

DÉCAPAGE  
STRIPPING

ÉLECTROPORTATIF  
HANDPOWER TOOLS

X-FIT  
RANGE

ATELIER  
WORKSHOP

BOIS  
WOOD MACHINES

MÉTAL  
METAL MACHINES

NETTOYAGE  
CLEANING

MÉTIERS  
MANUAL WORK

JARDIN FILAIRE  
GARDEN TOOLS

Plus d'info sur  
fartools.com

# Visseuse a plaque de plâtre - Drywall screwdriver - XF-Plaster

**18 V**  
2000 tr/min



**30** Une batterie unique pour **MACHINES**



Butée de profondeur réglable  
Adjustable depth gauge

- ▶ **Machine très légère : 1,1 kg**  
Very light machine : 1,1 kg
- ▶ **Variateur de vitesse électronique 0-2000 tr/min**  
Electronic variable speed 0-2000 rpm
- ▶ **Vissage-dévisage**  
Screw-unscrew
- ▶ **Crochet à la ceinture**  
Belt clip
- ▶ **Longueur de vis : 25-50 mm**  
Crew length: 25-50 mm
- ▶ **Butée de profondeur réglable**  
Adjustable screw depth



**SPEED**  
Control



**RUBBER**  
Grip



**REVERSE**  
Réversible



Visseuse a plaque de plâtre - Drywall screwdriver	XF-Plaster	KIT XF-Plaster
Gencode	<b>3431542160131</b>	<b>3431546162131</b>
Tension et puissance de la batterie - Battery voltage and power	<b>18 V</b>	<b>18 V - 1.5Ah</b>
Kit batterie / chargeur Battery / charger kit	<b>Sans batterie ni chargeur</b> Without battery nor charger	<b>1 batterie 1.5 Ah &amp; chargeur</b> 1.5 Battery & charger
Temps de charge indicatif - Indicative charge time	-	<b>40 min</b>
Variateur de vitesse électronique - Electronic variable speed	<b>0-2000 min<sup>-1</sup></b>	<b>0-2000 min<sup>-1</sup></b>

Données logistiques - Logistic informations

Box 250x80x270 mm | Master 10 x 1,2 kg | Pal 160 | Ctr 20ft 4800 pcs



Consommables - Consumables

XF-Bat 15 : Batterie 1.5 Ah - Battery 1.5 Ah	<b>3431542160155</b>	<b>3431542160155</b>
XF-Bat 40 : Batterie 4.0 Ah - Battery 4.0 Ah	<b>3431542160162</b>	<b>3431542160162</b>
XF-Bat 50 : Batterie 5.0 Ah - Battery 5.0 Ah	<b>3431542160193</b>	<b>3431542160193</b>
XF-Kit 15 : Batterie 1.5 Ah & chargeur rapide - Battery 1.5 Ah & charger	<b>3431542160179</b>	<b>3431542160179</b>
XF-Kit 15 : Batterie 4.0 Ah & chargeur rapide - Battery 4.0 Ah & charger	<b>3431542160185</b>	<b>3431542160185</b>
XF-Kit 15 : Batterie 5.0 Ah & chargeur rapide - Battery 5.0 Ah & charger	<b>3431542160353</b>	<b>3431542160353</b>

# Meuleuse d'angle - Angle grinder - XF-Grinder

18 V  
 ø 115 mm



**30** Une batterie unique pour  
**MACHINES**



- ▶ **Carter indexable sans outil**  
 Keyless carter adjustment
- ▶ **Poignée range clef**  
 Handle with spanner holder
- ▶ **Poignée 3 positions**  
 3 Positions handle
- ▶ **Blocage d'arbre**  
 Arbor lock

Livrée avec un disque  
 Delivered with 1 disc



**Arbor  
 Lock**



**RUBBER  
 Grip**



**x 3**



Meuleuse d'angle - Angle grinder	XF-Grinder	KIT XF-Grinder
Gencode	<b>3431542160049</b>	<b>3431546162049</b>
Tension et puissance de la batterie - Battery voltage and power	<b>18 V</b>	<b>18 V - 4.0 Ah</b>
Kit batterie / chargeur Battery / charger kit	<b>Sans batterie ni chargeur</b> Without battery nor charger	<b>1 batterie 4.0 Ah &amp; chargeur</b> 4.0 Battery & charger
Temps de charge indicatif - Indicative charge time	-	<b>100 min</b>
Vitesse de rotation - Rotation speed	<b>8000 min<sup>-1</sup></b>	<b>8000 min<sup>-1</sup></b>
Dimension du disque - Disc sizes	<b>ø 115 mm</b>	<b>ø 115 mm</b>

Données logistiques - Logistic informations

Box 325x115x130 mm | Master 4 x 2,1 kg | Pal 160 | Ctr 20ft 2780 pcs



Consommables - Consumables

XF-Bat 15 : Batterie 1.5 Ah - Battery 1.5 Ah	<b>3431542160155</b>	<b>3431542160155</b>
XF-Bat 40 : Batterie 4.0 Ah - Battery 4.0 Ah	<b>3431542160162</b>	<b>3431542160162</b>
XF-Bat 50 : Batterie 5.0 Ah - Battery 5.0 Ah	<b>3431542160193</b>	<b>3431542160193</b>
XF-Kit 15 : Batterie 1.5 Ah & chargeur rapide - Battery 1.5 Ah & charger	<b>3431542160179</b>	<b>3431542160179</b>
XF-Kit 15 : Batterie 4.0 Ah & chargeur rapide - Battery 4.0 Ah & charger	<b>3431542160185</b>	<b>3431542160185</b>
XF-Kit 15 : Batterie 5.0 Ah & chargeur rapide - Battery 5.0 Ah & charger	<b>3431542160353</b>	<b>3431542160353</b>

DÉCAPAGE  
 STRIPPING

ÉLECTROPORTATIF  
 HANDPOWER TOOLS

X-FIT  
 RANGE

ATELIER  
 WORKSHOP

BOIS  
 WOOD MACHINES

MÉTAL  
 METAL MACHINES

NETTOYAGE  
 CLEANING

MÉTIERS  
 MANUAL WORK

JARDIN FLAIRE  
 GARDEN TOOLS

Plus d'info sur  
**fartools.com**

# Meuleuse d'angle - Angle grinder - XFB-Grinder2

18 V  
 ø 125 mm



**30** Une batterie unique pour  
**MACHINES**



Meulage  
 Grinding

- ▶ **Carter indexable sans outil**  
 Keyless carter adjustment
- ▶ **Poignée range clef**  
 Handle with spanner holder
- ▶ **Poignée 3 positions**  
 3 Positions handle
- ▶ **Blocage d'arbre**  
 Arbor lock

Livrée avec un disque  
 Delivered with 1 disc



**Arbor Lock**



**RUBBER Grip**



**x 3**



**Moteur sans charbon**



Meuleuse d'angle - Angle grinder	XFB-Grinder2	KIT XFB-Grinder2
Gencode	<b>3431542160124</b>	<b>3431546162124</b>
Tension et puissance de la batterie - Battery voltage and power	<b>18 V</b>	<b>18 V - 1.5 Ah</b>
Kit batterie / chargeur Battery / charger kit	<b>Sans batterie ni chargeur</b> Without battery nor charger	<b>1 batterie 1.5 Ah &amp; chargeur</b> 1.5 Battery & charger
Temps de charge indicatif - Indicative charge time	-	<b>40 min</b>
Vitesse de rotation - Rotation speed	<b>8500 min<sup>-1</sup></b>	<b>8500 min<sup>-1</sup></b>
Dimension du disque - Disc sizes	<b>ø 125 mm</b>	<b>ø 125 mm</b>

Données logistiques - Logistic informations

Box 130x130x325 mm | Master 10 x 2,1 kg | Pal 150 | Ctr 20ft 3840 pcs



Consommables - Consumables

XF-Bat 15 : Batterie 1.5 Ah - Battery 1.5 Ah	<b>3431542160155</b>	<b>3431542160155</b>
XF-Bat 40 : Batterie 4.0 Ah - Battery 4.0 Ah	<b>3431542160162</b>	<b>3431542160162</b>
XF-Bat 50 : Batterie 5.0 Ah - Battery 5.0 Ah	<b>3431542160193</b>	<b>3431542160193</b>
XF-Kit 15 : Batterie 1.5 Ah & chargeur rapide - Battery 1.5 Ah & charger	<b>3431542160179</b>	<b>3431542160179</b>
XF-Kit 15 : Batterie 4.0 Ah & chargeur rapide - Battery 4.0 Ah & charger	<b>3431542160185</b>	<b>3431542160185</b>
XF-Kit 15 : Batterie 5.0 Ah & chargeur rapide - Battery 5.0 Ah & charger	<b>3431542160353</b>	<b>3431542160353</b>



# Rabot - Planer - XF-Planer

18 V  
60 mm



30 Une batterie unique pour  
MACHINES



Semelle 135 mm  
135 mm Sole

- ▶ Profondeur de rabotage réglable de 0 à 1,5 mm par molette crantée  
Plane depth adjustable 0 - 1,5 mm with knob
- ▶ Semelle de 135 mm  
135 mm sole
- ▶ Largeur de fer 60 mm  
Iron width 60 mm
- ▶ Sac de récupération des copeaux  
Chip collection bag

Livrée avec une lame réversible montée  
Delivered with 1 reversible mounted blade



Rabot - Planer	XF-Planer	KIT XF-Planer
Gencode	<b>3431542160247</b>	<b>3431546162247</b>
Tension et puissance de la batterie - Battery voltage and power	<b>18 V</b>	<b>18 V - 1.5 Ah</b>
Kit batterie / chargeur Battery / charger kit	<b>Sans batterie ni chargeur</b> Without battery nor charger	<b>1 batterie 1.5 Ah &amp; chargeur</b> 1.5 Battery & charger
Temps de charge indicatif - Indicative charge time	-	<b>40 min</b>
Vitesse de rotation - Rotation speed	<b>8000 min<sup>-1</sup></b>	<b>8000 min<sup>-1</sup></b>
Largeur du fer - Iron width	<b>60 mm</b>	<b>60 mm</b>

Données logistiques - Logistic informations

Box 185x135x270 mm | Master 10 x 2,25 kg | Pal 140 | Ctr 20ft 3000 pcs



Consommables - Consumables

2 Lames 82x6x1,25 mm - 2 Blades	<b>3431541150836</b>	<b>3431541150836</b>
XF-Bat 15 : Batterie 1.5 Ah - Battery 1.5 Ah	<b>3431542160155</b>	<b>3431542160155</b>
XF-Bat 40 : Batterie 4.0 Ah - Battery 4.0 Ah	<b>3431542160162</b>	<b>3431542160162</b>
XF-Bat 50 : Batterie 5.0 Ah - Battery 5.0 Ah	<b>3431542160193</b>	<b>3431542160193</b>
XF-Kit 15 : Batterie 1.5 Ah & chargeur rapide - Battery 1.5 Ah & charger	<b>3431542160179</b>	<b>3431542160179</b>
XF-Kit 15 : Batterie 4.0 Ah & chargeur rapide - Battery 4.0 Ah & charger	<b>3431542160185</b>	<b>3431542160185</b>
XF-Kit 15 : Batterie 5.0 Ah & chargeur rapide - Battery 5.0 Ah & charger	<b>3431542160353</b>	<b>3431542160353</b>

DÉCAPAGE  
STRIPPING

ÉLECTROPORTATIF  
HANDPOWER TOOLS

X-FIT  
RANGE

ATELIER  
WORKSHOP

BOIS  
WOOD MACHINES

MÉTAL  
METAL MACHINES

NETTOYAGE  
CLEANING

MÉTIERS  
MANUAL WORK

JARDIN FLEURE  
GARDEN TOOLS

Plus d'infos sur  
**fartools.com**

# Rénovateur de précision - Accuracy renovator - XF-Brush

18 V  
60 mm



**30** Une batterie unique pour **MACHINES**



**PRODUIT MALIN**  
SMART PRODUCT

CONSOMMABLES  
CONSUMABLES

Voir page - See on page 77



Brosse largeur 60 mm  
60 mm Width brush

- ▶ **Corps ergonomique, travail avec une main**  
Ergonomic body, work with one hand
- ▶ **Brosse diamètre et largeur 60 mm**  
Brush width and diameter 60 mm
- ▶ **Variateur de vitesse électronique**  
Electronic variable speed
- ▶ **Blocage d'arbre**  
Arbor lock

Livré avec 3 broses  
Delivered with 3 brushes



**SPEED**  
Control



**Dust**  
Collector



**RUBBER**  
Grip



**Arbor**  
Lock



Rénovateur de précision - Accuracy renovator	XF-Brush	KIT XF-Brush
Gencode	<b>3431542160209</b>	<b>3431546162209</b>
Tension et puissance de la batterie - Battery voltage and power	<b>18 V</b>	<b>18 V - 1.5 Ah</b>
Kit batterie / chargeur Battery / charger kit	<b>Sans batterie ni chargeur</b> Without battery nor charger	<b>1 batterie 1.5 Ah &amp; chargeur</b> 1.5 Battery & charger
Temps de charge indicatif - Indicative charge time	-	<b>40 min</b>
Variateur de vitesse électronique - Electronic variable speed	<b>1600 - 3000 min<sup>-1</sup></b>	<b>1600 - 3000 min<sup>-1</sup></b>
Dimension de la brosse - brush sizes	<b>ø 60x60 mm</b>	<b>ø 60x60 mm</b>

Données logistiques - Logistic informations

Box 105x140x415 mm | Master 6 x 1,7 kg | Pal 126 | Ctr 20ft 4812 pcs



Consommables - Consumables

XF-Bat 15 : Batterie 1.5 Ah - Battery 1.5 Ah	<b>3431542160155</b>	<b>3431542160155</b>
XF-Bat 40 : Batterie 4.0 Ah - Battery 4.0 Ah	<b>3431542160162</b>	<b>3431542160162</b>
XF-Bat 50 : Batterie 5.0 Ah - Battery 5.0 Ah	<b>3431542160193</b>	<b>3431542160193</b>
XF-Kit 15 : Batterie 1.5 Ah & chargeur rapide - Battery 1.5 Ah & charger	<b>3431542160179</b>	<b>3431542160179</b>
XF-Kit 15 : Batterie 4.0 Ah & chargeur rapide - Battery 4.0 Ah & charger	<b>3431542160185</b>	<b>3431542160185</b>
XF-Kit 15 : Batterie 5.0 Ah & chargeur rapide - Battery 5.0 Ah & charger	<b>3431542160353</b>	<b>3431542160353</b>

# Ponceuse delta - Delta sander - XF-Delta

18 V  
Delta



30 Une batterie unique pour  
MACHINES



Ergonomique  
Ergonomic

- ▶ Filtration par cartouche à poussières  
Dust cartridge filter
- ▶ Patin auto-agrippant  
Hook & loop fastening pad
- ▶ Dimensions du patin 140x140x100 mm  
Pad size 140x140x100 mm

Livrée avec 3 feuilles abrasives  
Delivered with 3 abrasive papers



RUBBER  
Grip

VELCRO

Cartridge  
Cartouche

Ponceuse delta - Delta sander	XF-Delta	KIT XF-Delta
Gencode	3431542160254	3431546162254
Tension et puissance de la batterie - Battery voltage and power	18 V	18 V - 1.5 Ah
Kit batterie / chargeur Battery / charger kit	Sans batterie ni chargeur Without battery nor charger	1 batterie 1.5 Ah & chargeur 1.5 Battery & charger
Temps de charge indicatif - Indicative charge time	-	40 min
Vitesse de rotation - Rotation speed	11000 min <sup>-1</sup>	11000 min <sup>-1</sup>
Dimension du patin - Pad sizes	140x140x100 mm	140x140x100 mm
Fixation par Velcro - Velcro grips	Ok	Ok
Données logistiques - Logistic informations		

Box 230x160x105 mm | Master 10 x 1,1 kg | Pal 240 | Ctr 20ft 6930 pcs



Consommables - Consumables

6 Papiers abrasifs 2 x A40/A80/A120 - 6 Abrasives set	3431541158634	3431541158634
XF-Bat 15 : Batterie 1.5 Ah - Battery 1.5 Ah	3431542160155	3431542160155
XF-Bat 40 : Batterie 4.0 Ah - Battery 4.0 Ah	3431542160162	3431542160162
XF-Bat 50 : Batterie 5.0 Ah - Battery 5.0 Ah	3431542160193	3431542160193
XF-Kit 15 : Batterie 1.5 Ah & chargeur rapide - Battery 1.5 Ah & charger	3431542160179	3431542160179
XF-Kit 15 : Batterie 4.0 Ah & chargeur rapide - Battery 4.0 Ah & charger	3431542160185	3431542160185
XF-Kit 15 : Batterie 5.0 Ah & chargeur rapide - Battery 5.0 Ah & charger	3431542160353	3431542160353

DÉCAPAGE  
STRIPPING

ÉLECTROPORTATIF  
HANDPOWER TOOLS

X-FIT  
RANGE

ATELIER  
WORKSHOP

BOIS  
WOOD MACHINES

MÉTAL  
METAL MACHINES

NETTOYAGE  
CLEANING

MÉTIERS  
MANUAL WORK

JARDIN FLEAIRE  
GARDEN TOOLS

Plus d'info sur  
fartools.com

# Ponceuse orbitale - Orbital sander - XF-Orbital2

18 V  
 ø 125 mm



**30** Une batterie unique pour  
**MACHINES**



Prise en main ergonomique  
 Ergonomic handle

- ▶ **Disque ø 125 mm**  
 Disc 125 mm diameter
- ▶ **Patin auto-agrippant**  
 Hook & loop fastening pad
- ▶ **Prise en main ergonomique**  
 Ergonomic handle
- ▶ **Buse d'évacuation des poussières et sac de récupération**  
 Dust evacuation nozzle

Livrée avec 3 feuilles abrasives et sac à poussières  
 Delivered with 3 abrasive papers and dust bag



**RUBBER**  
 Grip

**VELCRO**



Ponceuse delta - Delta sander	XF-Orbital2	KIT XF-Orbital2
Gencode	<b>3431542160339</b>	<b>3431546162339</b>
Tension et puissance de la batterie - Battery voltage and power	<b>18 V</b>	<b>18 V - 1.5 Ah</b>
Kit batterie / chargeur Battery / charger kit	<b>Sans batterie ni chargeur</b> Without battery nor charger	<b>1 batterie 1.5 Ah &amp; chargeur</b> 1.5 Battery & charger
Temps de charge indicatif - Indicative charge time	-	<b>40 min</b>
Vitesse de rotation - Rotation speed	<b>10000 min<sup>-1</sup></b>	<b>10000 min<sup>-1</sup></b>
Dimension du patin - Pad sizes	<b>ø 125 mm</b>	<b>ø 125 mm</b>
Fixation par Velcro - Velcro grips	<b>Ok</b>	<b>Ok</b>
Données logistiques - Logistic informations		

Box 225x180x135 mm | Master 12 x 2,25 kg | Pal 144 | Ctr 20ft 2500 pcs



### Consommables - Consumables

6 Papiers abrasifs 2 x A40/A80/A120 - 6 Abrasives set	<b>3431541158498</b>	<b>3431541158498</b>
XF-Bat 15 : Batterie 1.5 Ah - Battery 1.5 Ah	<b>3431542160155</b>	<b>3431542160155</b>
XF-Bat 40 : Batterie 4.0 Ah - Battery 4.0 Ah	<b>3431542160162</b>	<b>3431542160162</b>
XF-Bat 50 : Batterie 5.0 Ah - Battery 5.0 Ah	<b>3431542160193</b>	<b>3431542160193</b>
XF-Kit 15 : Batterie 1.5 Ah & chargeur rapide - Battery 1.5 Ah & charger	<b>3431542160179</b>	<b>3431542160179</b>
XF-Kit 15 : Batterie 4.0 Ah & chargeur rapide - Battery 4.0 Ah & charger	<b>3431542160185</b>	<b>3431542160185</b>
XF-Kit 15 : Batterie 5.0 Ah & chargeur rapide - Battery 5.0 Ah & charger	<b>3431542160353</b>	<b>3431542160353</b>



**30** Une batterie unique pour **MACHINES**



«Un gain de temps grâce à son système de changement d'accessoires.»

Diarmuid D.



Idéal pour couper de la plaque de plâtre  
Perfect for plasterboard

- ▶ **Changement d'outils sans clef**  
Keyless tool release
- ▶ **Variateur de vitesse : 5000-15000 tr/min**  
Variable speed: 5000-15000 tr/min
- ▶ **Angle d'oscillation : 3.0°**  
Oscillation angle: 3.0°

Livré avec spatule courte, spatule large et plateau de ponçage avec 3 patins  
Delivered with short tool, large tool and sanding base, with 3 sheets



**Print**  
Empreinte



**RUBBER**  
Grip



**SPEED**  
Control



Outil multi fonctions - Multi purpose tool	XF-Tools	KIT XF-Tools
Gencode	<b>3431542160032</b>	<b>3431546162032</b>
Tension et puissance de la batterie - Battery voltage and power	<b>18 V</b>	<b>18 V - 1.5 Ah</b>
Kit batterie / chargeur Battery / charger kit	<b>Sans batterie ni chargeur</b> Without battery nor charger	<b>1 batterie 1.5 Ah &amp; chargeur</b> 1.5 Battery & charger
Temps de charge indicatif - Indicative charge time	-	<b>40 min</b>
Variateur de vitesse électronique - Electronic variable speed	<b>5000 - 15000 min<sup>-1</sup></b>	<b>5000 - 15000 min<sup>-1</sup></b>
Angle d'oscillation - Oscillation angle	<b>3,0°</b>	<b>3,0°</b>

Données logistiques - Logistic informations

Box 275x110x115 mm | Master 4 x 1,45 kg | Pal 216 | Ctr 20ft 6480 pcs



Consommables - Consumables

XF-Bat 15 : Batterie 1.5 Ah - Battery 1.5 Ah	<b>3431542160155</b>	<b>3431542160155</b>
XF-Bat 40 : Batterie 4.0 Ah - Battery 4.0 Ah	<b>3431542160162</b>	<b>3431542160162</b>
XF-Bat 50 : Batterie 5.0 Ah - Battery 5.0 Ah	<b>3431542160193</b>	<b>3431542160193</b>
XF-Kit 15 : Batterie 1.5 Ah & chargeur rapide - Battery 1.5 Ah & charger	<b>3431542160179</b>	<b>3431542160179</b>
XF-Kit 15 : Batterie 4.0 Ah & chargeur rapide - Battery 4.0 Ah & charger	<b>3431542160185</b>	<b>3431542160185</b>
XF-Kit 15 : Batterie 5.0 Ah & chargeur rapide - Battery 5.0 Ah & charger	<b>3431542160353</b>	<b>3431542160353</b>

# Agrafeuse / cloueuse - Stapler / nailer - XF-Stapler

18 V  
22/32 mm



**30** Une batterie unique pour **MACHINES**



«Son variateur permet de travailler même dans du chêne sec.»  
Diarmud D.



Prise en main ergonomique  
Ergonomic handle

- ▶ **2en1 : clous (32 mm max) Type 47 / agrafes (22 mm max) Type 55**  
2 in 1: nails (32 mm max) Type 47 / staples (22 mm max) Type 55
- ▶ **Contact de sécurité et réglage de puissance**  
Security contact and torque adjustment
- ▶ **Puissance d'agrafage ajustable par molette**  
Adjustable staple power with thumbwheel
- ▶ **Lumière LED pour éclairer la zone de travail**  
LED light to illuminate the work area
- ▶ **Crochet pour la ceinture**  
Belt clip

Livrée avec 1000 agrafes et 2500 clous  
Delivered with 1000 staples & 2500 nails

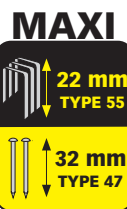

**SPEED**  
Control



**RUBBER**  
Grip



**22-32**  
mm



**LED**  
Light



Agrafeuse cloueuse - Stapler / nailer	XF-Stapler	KIT XF-Stapler
Gencode	<b>3431542160230</b>	<b>3431546162230</b>
Tension et puissance de la batterie - Battery voltage and power	<b>18 V</b>	<b>18 V - 1.5 Ah</b>
Kit batterie / chargeur Battery / charger kit	<b>Sans batterie ni chargeur</b> Without battery nor charger	<b>1 batterie 1.5 Ah &amp; chargeur</b> 1.5 Battery & charger
Temps de charge indicatif - Indicative charge time	-	<b>40 min</b>
Dimensions agrafes / pointes - Staples / nails sizes	<b>22 mm - Type 55 / 32 mm - Type 47</b>	

Données logistiques - Logistic informations

Box 185x135x270 mm | Master 10 x 2,25 kg | Pal 140 | Ctr 20ft 3000 pcs



Consommables - Consumables

5000 Agrafes 22 mm type 55 - Staples	<b>3431541159129</b>	<b>3431541159129</b>
5000 Clous 32 mm type 47- Nails	<b>3431541159112</b>	<b>3431541159112</b>
XF-Bat 15 : Batterie 1.5 Ah - Battery 1.5 Ah	<b>3431542160155</b>	<b>3431542160155</b>
XF-Bat 40 : Batterie 4.0 Ah - Battery 4.0 Ah	<b>3431542160162</b>	<b>3431542160162</b>
XF-Bat 50 : Batterie 5.0 Ah - Battery 5.0 Ah	<b>3431542160193</b>	<b>3431542160193</b>
XF-Kit 15 : Batterie 1.5 Ah & chargeur rapide - Battery 1.5 Ah & charger	<b>3431542160179</b>	<b>3431542160179</b>
XF-Kit 15 : Batterie 4.0 Ah & chargeur rapide - Battery 4.0 Ah & charger	<b>3431542160185</b>	<b>3431542160185</b>
XF-Kit 15 : Batterie 5.0 Ah & chargeur rapide - Battery 5.0 Ah & charger	<b>3431542160353</b>	<b>3431542160353</b>

# Pistolet à air chaud - Hot air gun - XF-Heatergun

18 V  
550°C



**30** Une batterie unique pour  
**MACHINES**



Sans fil  
Cordless

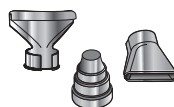

- ▶ **Température de chauffe : 550° C**  
Heating temperature: 550 °C
- ▶ **Temps de chauffe rapide : 5 s**  
Quick heating time: 5 s
- ▶ **Système de changement rapide des buses**  
Quick nozzle change system
- ▶ **Lumière d'éclairage LED**  
LED lighting light
- ▶ **Crochet d'attache**  
Hook hanging

Livré avec 3 buses  
Delivered with 3 nozzles



**550°  
Max**



**LED  
Light**



**RUBBER  
Grip**



**200L/min**



Pistolet à air chaud - Hot air gun

	XF-Heatergun	KIT XF-Heatergun
Gencode	<b>3431542160292</b>	<b>3431546162292</b>
Tension et puissance de la batterie - Battery voltage and power	<b>18 V</b>	<b>18 V - 4.0 Ah</b>
Kit batterie / chargeur Battery / charger kit	<b>Sans batterie ni chargeur</b> Without battery nor charger	<b>1 batterie 4.0 Ah &amp; chargeur</b> 4.0 Battery & charger
Temps de charge indicatif - Indicative charge time	-	<b>100 min</b>
Allure de chauffe - Heat setting	<b>550°C</b>	<b>550°C</b>
Vitesse de ventilation - Fan speed	<b>200L/min</b>	<b>200L/min</b>

Données logistiques - Logistic informations

Box 170x220x80 mm | Master 8 x 0,95 kg | Pal 288 | Ctr 20ft 8000 pcs



Consommables - Consumables

XF-Bat 15 : Batterie 1.5 Ah - Battery 1.5 Ah	3431542160155	3431542160155
XF-Bat 40 : Batterie 4.0 Ah - Battery 4.0 Ah	3431542160162	3431542160162
XF-Bat 50 : Batterie 5.0 Ah - Battery 5.0 Ah	3431542160193	3431542160193
XF-Kit 15 : Batterie 1.5 Ah & chargeur rapide - Battery 1.5 Ah & charger	3431542160179	3431542160179
XF-Kit 15 : Batterie 4.0 Ah & chargeur rapide - Battery 4.0 Ah & charger	3431542160185	3431542160185
XF-Kit 15 : Batterie 5.0 Ah & chargeur rapide - Battery 5.0 Ah & charger	3431542160353	3431542160353

DÉCAPAGE  
STRIPPING

ÉLECTROPORTATIF  
HANDPOWER TOOLS

X-FIT  
RANGE

ATELIER  
WORKSHOP

BOIS  
WOOD MACHINES

MÉTAL  
METAL MACHINES

NETTOYAGE  
CLEANING

MÉTIERS  
MANUAL WORK

JARDIN FILAIRE  
GARDEN TOOLS

Plus d'info sur  
**fartools.com**

# Grignoteuse à tôle - Nibbler - XFB-Nibbler

18 V  
1,2 mm



**30** Une batterie unique pour  
**MACHINES**



Idéale pour le bardage  
Usefull for cladding

- ▶ **Tête de coupe 4 positions**  
4 Positions cutting head
- ▶ **Capacité maximum : 1,2 mm dans l'acier / 0,8 mm dans l'inox**  
Maximum capacity : 1,2 mm for steel / 0,8 mm for stainless steel
- ▶ **Poignée 2 positions**  
2 Positions handle
- ▶ **Vitesse : 1200 tr/min**  
Speed: 1200 rpm

Livrée avec poignée auxiliaire gauche-droite et un poinçon  
Delivered with left/right auxiliary handle



**BRUSHLESS  
MOTOR**

Moteur  
sans charbon



Grignoteuse à tôle - Nibbler	XFB-Nibbler	KIT XFB-Nibbler
Gencode	<b>3431542160223</b>	<b>3431546162223</b>
Tension et puissance de la batterie - Battery voltage and power	<b>18 V</b>	<b>18 V - 1.5 Ah</b>
Kit batterie / chargeur Battery / charger kit	<b>Sans batterie ni chargeur</b> Without battery nor charger	<b>1 batterie 1.5 Ah &amp; chargeur</b> 1.5 Battery & charger
Temps de charge indicatif - Indicative charge time	-	<b>40 min</b>
Vitesse de rotation - Rotation speed	<b>1200 min<sup>-1</sup></b>	<b>1200 min<sup>-1</sup></b>
Capacité maxi - Max capacity	<b>1,2 mm</b>	<b>1,2 mm</b>

Données logistiques - Logistic informations

Box 170x80x320 mm | Master 10 x 2,1 kg | Pal 240 | Ctr 20ft 5100 pcs



Consommables - Consumables

Jeu de 2 poinçons - Set of 2 punches	<b>3431541150829</b>	<b>3431541150829</b>
XF-Bat 15 : Batterie 1.5 Ah - Battery 1.5 Ah	<b>3431542160155</b>	<b>3431542160155</b>
XF-Bat 40 : Batterie 4.0 Ah - Battery 4.0 Ah	<b>3431542160162</b>	<b>3431542160162</b>
XF-Bat 50 : Batterie 5.0 Ah - Battery 5.0 Ah	<b>3431542160193</b>	<b>3431542160193</b>
XF-Kit 15 : Batterie 1.5 Ah & chargeur rapide - Battery 1.5 Ah & charger	<b>3431542160179</b>	<b>3431542160179</b>
XF-Kit 15 : Batterie 4.0 Ah & chargeur rapide - Battery 4.0 Ah & charger	<b>3431542160185</b>	<b>3431542160185</b>
XF-Kit 15 : Batterie 5.0 Ah & chargeur rapide - Battery 5.0 Ah & charger	<b>3431542160353</b>	<b>3431542160353</b>



# Scie sauteuse - Jig saw - XF-Jig

18 V  
60 mm Max



**30** Une batterie unique pour  
**MACHINES**



Sans risque pour le câble d'alimentation  
No risk for power supply

- ▶ **Changement d'outil sans clef**  
Keyless tool release
- ▶ **Variateur de vitesse : 0-2600 tr/min**  
Variable speed: 0-2600 tr/min
- ▶ **Base inclinable 0 à 45°**  
Tilting base from 0 to 45°
- ▶ **Fonction pendulaire**  
Pendular function

Livrée avec guide parallèle et 2 lames  
Delivered with parallel guide and 2 blades



**SPEED**  
Control



**RUBBER**  
Grip



**PENDULAIRE**  
Pendulaire



**T type**  
Type T



Scie sauteuse - Jig saw	XF-Jig	KIT XF-Jig
Gencode	<b>3431542160094</b>	<b>3431546162094</b>
Tension et puissance de la batterie - Battery voltage and power	<b>18 V</b>	<b>18 V - 1.5 Ah</b>
Kit batterie / chargeur Battery / charger kit	<b>Sans batterie ni chargeur</b> Without battery nor charger	<b>1 batterie 1.5 Ah &amp; chargeur</b> 1.5 Battery & charger
Temps de charge indicatif - Indicative charge time	-	<b>40 min</b>
Variateur de vitesse électronique - Electronic variable speed	<b>0 - 2600 min<sup>-1</sup></b>	<b>0 - 2600 min<sup>-1</sup></b>
Base inclinable - Tilting base	<b>0-45°</b>	<b>0-45°</b>
Capacité de coupe dans le bois / métal - Wood/metal cutting capacities	<b>60 / 6 mm</b>	<b>60 / 6 mm</b>
Données logistiques - Logistic informations		

Box 230x80x245 mm | Master 4 x 2,20 kg | Pal 180 | Ctr 20ft 5112 pcs



3 431542 160094



3 431546 162094

### Consommables - Consumables

10 Lames T, 6/10 TPI bois & PVC Set of 10 T blades, 6/10 TPI for wood & plastic	<b>3431541158719</b>	<b>3431541158719</b>
XF-Bat 15 : Batterie 1.5 Ah - Battery 1.5 Ah	<b>3431542160155</b>	<b>3431542160155</b>
XF-Bat 40 : Batterie 4.0 Ah - Battery 4.0 Ah	<b>3431542160162</b>	<b>3431542160162</b>
XF-Bat 50 : Batterie 5.0 Ah - Battery 5.0 Ah	<b>3431542160193</b>	<b>3431542160193</b>
XF-Kit 15 : Batterie 1.5 Ah & chargeur rapide - Battery 1.5 Ah & charger	<b>3431542160179</b>	<b>3431542160179</b>
XF-Kit 15 : Batterie 4.0 Ah & chargeur rapide - Battery 4.0 Ah & charger	<b>3431542160185</b>	<b>3431542160185</b>
XF-Kit 15 : Batterie 5.0 Ah & chargeur rapide - Battery 5.0 Ah & charger	<b>3431542160353</b>	<b>3431542160353</b>

DÉCAPAGE  
STRIPPING

ÉLECTROPORTATIF  
HANDPOWER TOOLS

X-FIT  
RANGE

ATELIER  
WORKSHOP

BOIS  
WOOD MACHINES

MÉTAL  
METAL MACHINES

NETTOYAGE  
CLEANING

MÉTIER  
MANUAL WORK

JARDIN FILAIRE  
GARDEN TOOLS

Plus d'info sur  
**fartools.com**

# Scie circulaire - Circular saw - XF-Circular

18 V  
 ø 165 mm



**30** Une batterie unique pour  
**MACHINES**



Réglage hauteur de coupe  
 Cutting height adjustment

- ▶ **Base et carter Aluminium**  
 Aluminium base & carter
  - ▶ **Vitesse : 3800 tr/min**  
 Speed: 3800 rpm
  - ▶ **Lame inclinable 0 à 45°**  
 Tilting blade from 0 to 45°
  - ▶ **Blocage d'arbre**  
 Arbor lock
  - ▶ **Hauteur de coupe réglable 0 à 50 mm**  
 0 to 50 mm cutting height adjustment
- Livrée avec guide parallèle*  
 Delivered with parallel guide



**Arbor Lock**



**RUBBER Grip**



**Dust Collector**



Scie circulaire - Circular saw	XF-Circular	KIT XF-Circular
Gencode	<b>3431542160056</b>	<b>3431546162056</b>
Tension et puissance de la batterie - Battery voltage and power	<b>18 V</b>	<b>18 V - 1.5 Ah</b>
Kit batterie / chargeur Battery / charger kit	<b>Sans batterie ni chargeur</b> Without battery nor charger	<b>1 batterie 1.5 Ah &amp; chargeur</b> 1.5 Battery & charger
Temps de charge indicatif - Indicative charge time	-	<b>40 min</b>
Diamètre / alésage de la lame - Blade diameter / bore	ø 165 / 20 mm	ø 165 / 20 mm
Nombre de dents - Teeth number	20 T	20 T
Vitesse de rotation - Rotation speed	<b>3800 min<sup>-1</sup></b>	<b>3800 min<sup>-1</sup></b>
Lame inclinable - Tilting blade	<b>0-45°</b>	<b>0-45°</b>
Capacité de coupe dans le bois Wood cutting capacities	<b>90° = 50 mm</b> <b>45° = 30 mm</b>	<b>90° = 50 mm</b> <b>45° = 30 mm</b>

Données logistiques - Logistic informations

Box 235x185x300 mm | Master 2 x 3,25 kg | Pal 72 | Ctr 20ft 1664 pcs



Consommables - Consumables

Lame 48T - 48T Blade	3431541158399	3431541158399
Lame 24T - 48T Blade	3431541158313	3431541158313
XF-Bat 15 : Batterie 1.5 Ah - Battery 1.5 Ah	3431542160155	3431542160155
XF-Bat 40 : Batterie 4.0 Ah - Battery 4.0 Ah	3431542160162	3431542160162
XF-Bat 50 : Batterie 5.0 Ah - Battery 5.0 Ah	3431542160193	3431542160193
XF-Kit 15 : Batterie 1.5 Ah & chargeur rapide - Battery 1.5 Ah & charger	3431542160179	3431542160179
XF-Kit 15 : Batterie 4.0 Ah & chargeur rapide - Battery 4.0 Ah & charger	3431542160185	3431542160185
XF-Kit 15 : Batterie 5.0 Ah & chargeur rapide - Battery 5.0 Ah & charger	3431542160353	3431542160353

# Scie sabre - Reciprocating saw - XF-Saw2

18 V  
90 mm Max



**30** Une batterie unique pour **MACHINES**



Réglage support de l'outil  
Tools support adjustment

- ▶ **Changement d'outils sans clef**  
Keyless tool release
- ▶ **Variateur de vitesse : 0-3000 tr/min**  
Variable speed: 0-3000 tr/min
- ▶ **Fonction pendulaire**  
Pendular function
- ▶ **Capacité Bois = 90 mm / Métal = 10 mm**  
Capacity wood = 90 mm / Metal = 10 mm

Livrée avec une lame bois et une lame métal  
Delivered with wood and metal blade



**SPEED**  
Control



**RUBBER**  
Grip



**Universal**  
Universel



Scie sabre - Reciprocating saw	XF-Saw2	KIT XF-Saw2
Gencode	<b>3431542160063</b>	<b>3431546162063</b>
Tension et puissance de la batterie - Battery voltage and power	<b>18 V</b>	<b>18 V - 1.5 Ah</b>
Kit batterie / chargeur Battery / charger kit	<b>Sans batterie ni chargeur</b> Without battery nor charger	<b>1 batterie 1.5 Ah &amp; chargeur</b> 1.5 Battery & charger
Temps de charge indicatif - Indicative charge time	-	<b>40 min</b>
Variateur de vitesse électronique - Electronic variable speed	<b>0-3000 min<sup>-1</sup></b>	<b>0-3000 min<sup>-1</sup></b>
Capacité de coupe dans le bois/métal Wood/metal cutting capacities	<b>90 / 10 mm</b>	<b>90 / 10 mm</b>

Données logistiques - Logistic informations

Box 170x80x440 mm | Master 4 x 2,2 kg | Pal 128 | Ctr 20ft 3740 pcs



Consommables - Consumables

XF-Bat 15 : Batterie 1.5 Ah - Battery 1.5 Ah	3431542160155	3431542160155
XF-Bat 40 : Batterie 4.0 Ah - Battery 4.0 Ah	3431542160162	3431542160162
XF-Bat 50 : Batterie 5.0 Ah - Battery 5.0 Ah	3431542160193	3431542160193
XF-Kit 15 : Batterie 1.5 Ah & chargeur rapide - Battery 1.5 Ah & charger	3431542160179	3431542160179
XF-Kit 15 : Batterie 4.0 Ah & chargeur rapide - Battery 4.0 Ah & charger	3431542160185	3431542160185
XF-Kit 15 : Batterie 5.0 Ah & chargeur rapide - Battery 5.0 Ah & charger	3431542160353	3431542160353

DÉCAPAGE  
STRIPPING

ÉLECTROPORTATIF  
HANDPOWER TOOLS

X-FIT  
RANGE

ATELIER  
WORKSHOP

BOIS  
WOOD MACHINES

MÉTAL  
METAL MACHINES

NETTOYAGE  
CLEANING

MÉTIER  
MANUAL WORK

JARDIN FLAIRE  
GARDEN TOOLS

Plus d'info sur  
**fartools.com**

# Gonfleur / compresseur - Inflator / compressor - XF-Comp

18 V  
11 Bar Max



30 Une batterie unique pour  
MACHINES



Embout pneus, ballons, petits volumes  
Tire tip, balloons, small volumes



- ▶ Pression max 11 Bar / 1100k Pa  
Max pressure 11 Bar / 1100k Pa
- ▶ Ecran digital de contrôle, indicateur de pression  
Digital control screen with pressure indicator
- ▶ Fonction gonfleur  
Inflator function

Livré avec multiples buses de gonflage et chargeur allume cigare  
Delivered with multiple inflation nozzles and cigarette lighter charger



Gonfleur / compresseur - Inflator / compressor	XF-Comp	KIT XF-Comp
Gencode	3431542160278	3431546162278
Tension et puissance de la batterie - Battery voltage and power	18 V	18 V - 1.5 Ah
Kit batterie / chargeur Battery / charger kit	Sans batterie ni chargeur Without battery nor charger	1 batterie 1.5 Ah & chargeur 1.5 Battery & charger
Temps de charge indicatif - Indicative charge time	-	40 min
Pression Pressure	11 Bar 1100 kpa	11 Bar 1100 kpa

Données logistiques - Logistic informations

Box 225x155x240 mm | Master 4 x 1,95 kg | Pal 120 | Ctr 20ft 3240 pcs



Consommables - Consumables

XF-Bat 15 : Batterie 1.5 Ah - Battery 1.5 Ah	3431542160155	3431542160155
XF-Bat 40 : Batterie 4.0 Ah - Battery 4.0 Ah	3431542160162	3431542160162
XF-Bat 50 : Batterie 5.0 Ah - Battery 5.0 Ah	3431542160193	3431542160193
XF-Kit 15 : Batterie 1.5 Ah & chargeur rapide - Battery 1.5 Ah & charger	3431542160179	3431542160179
XF-Kit 15 : Batterie 4.0 Ah & chargeur rapide - Battery 4.0 Ah & charger	3431542160185	3431542160185
XF-Kit 15 : Batterie 5.0 Ah & chargeur rapide - Battery 5.0 Ah & charger	3431542160353	3431542160353

# Aspirateur vide cendres - Ashes vacuum cleaner - XF-Ashes

18 V  
8 kpa



**30** Une batterie unique pour **MACHINES**



Multi applications  
Different uses



«Bonne autonomie, efficace, léger et compact : que des points positifs.»  
Laurent L.

- ▶ **Autonome avec son propre moteur**  
Autonomous with its own engine
- ▶ **Cuve métal de 15 litres**  
Metal tank of 15 liters
- ▶ **Poignée pour transport facile**  
Handle for easy carrying
- ▶ **Filtre à cartouche pour les poussières les plus fines**  
Cartridge filter for thin dust



Livré avec un filtre cartouche et un tube inox 1 m, ø 30 mm  
Delivered with cartridge filter and a inox tube 1 m, ø 30 mm



Aspirateur vide cendres - Ashes vacuum cleaner	XF-Ashes	KIT XF-Ashes
Gencode	<b>3431542160322</b>	<b>3431546162322</b>
Tension et puissance de la batterie - Battery voltage and power	<b>18 V</b>	<b>18 V - 1.5 Ah</b>
Kit batterie / chargeur Battery / charger kit	<b>Sans batterie ni chargeur</b> Without battery nor charger	<b>1 batterie 1.5 Ah &amp; chargeur</b> 1.5 Battery & charger
Temps de charge indicatif - Indicative charge time	-	<b>40 min</b>
Volume de la cuve - Tank volume	<b>15 L</b>	<b>15 L</b>
Puissance - Power	<b>8 kpa</b>	<b>8 kpa</b>
Longueur du tuyau Hose length	<b>ø 30 mm</b> <b>1 m / Inox</b>	<b>ø 30 mm</b> <b>1 m / Inox</b>
Données logistiques - Logistic informations		

Box 285x390x280 mm | Master 1 x 2,8 kg | Pal 40 | Ctr 20ft 958 pcs



### Consommables - Consumables

Filtre cartouche - Cartridge filter	3431541018549	3431541018549
XF-Bat 15 : Batterie 1.5 Ah - Battery 1.5 Ah	3431542160155	3431542160155
XF-Bat 40 : Batterie 4.0 Ah - Battery 4.0 Ah	3431542160162	3431542160162
XF-Bat 50 : Batterie 5.0 Ah - Battery 5.0 Ah	3431542160193	3431542160193
XF-Kit 15 : Batterie 1.5 Ah & chargeur rapide - Battery 1.5 Ah & charger	3431542160179	3431542160179
XF-Kit 15 : Batterie 4.0 Ah & chargeur rapide - Battery 4.0 Ah & charger	3431542160185	3431542160185
XF-Kit 15 : Batterie 5.0 Ah & chargeur rapide - Battery 5.0 Ah & charger	3431542160353	3431542160353

DÉCAPAGE  
STRIPPING

ÉLECTROPORATIF  
HANDPOWER TOOLS

X-FIT  
RANGE

ATELIER  
WORKSHOP

BOIS  
WOOD MACHINES

MÉTAL  
METAL MACHINES

NETTOYAGE  
CLEANING

MÉTIERS  
MANUAL WORK

JARDIN FILAIRE  
GARDEN TOOLS

Plus d'info sur  
**fartools.com**

# Aspirateur eau et poussières - Vacuum cleaner - XFB-Vacuum

18 V  
16 kpa



**30** Une batterie unique pour **MACHINES**



Tube extensible  
Stretch hose

- ▶ **Eau et poussières**  
Water & dusts
- ▶ **Cuve polypropylène 10 L**  
Polypropylene tank 10 L
- ▶ **Fonction souffleur**  
Blower function
- ▶ **2 niveaux de puissance (11 - 16 kpa)**  
2 power levels (11 - 16 kpa)
- ▶ **Poignée pour transport facile**  
Handle for easy carrying

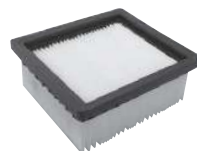

Livré avec flexible 1,3 m, extension 1,5 m, petite brosse plate et filtre cartouche  
Delivered with 1.3 m hose, 1.5 m extension, small flat brush and cartridge filter



**Blowing**  
Souffleur



**WET&DRY**

**BRUSHLESS  
MOTOR**

Moteur  
sans charbon



Aspirateur eau et poussières - Vacuum cleaner	XFB-Vacuum	KIT XFB-Vacuum
Gencode	<b>3431542160216</b>	<b>3431546162216</b>
Tension et puissance de la batterie - Battery voltage and power	<b>18 V</b>	<b>18 V - 1.5 Ah</b>
Kit batterie / chargeur Battery / charger kit	<b>Sans batterie ni chargeur</b> Without battery nor charger	<b>1 batterie 1.5 Ah &amp; chargeur</b> 1.5 Battery & charger
Temps de charge indicatif - Indicative charge time	-	<b>40 min</b>
Volume de la cuve - Tank volume	<b>10 L</b>	<b>10 L</b>
Puissance / débit d'air - Power / Air flow volume	<b>11 / 16 kpa / 10dm<sup>3</sup>/s</b>	<b>11 / 16 kpa / 10dm<sup>3</sup>/s</b>
Longueur du tuyau Hose length	<b>ø 40 mm</b> <b>1,3 + 1,5 m</b>	<b>ø 40 mm</b> <b>1,3 + 1,5 m</b>
Données logistiques - Logistic informations		
Box 340x250x350 mm   Master 1 x 3,65 kg   Pal 36   Ctr 20ft 960 pcs		

### Consommables - Consumables

Filtre cartouche - Cartridge filter	<b>3431541018556</b>	<b>3431541018556</b>
XF-Bat 15 : Batterie 1.5 Ah - Battery 1.5 Ah	<b>3431542160155</b>	<b>3431542160155</b>
XF-Bat 40 : Batterie 4.0 Ah - Battery 4.0 Ah	<b>3431542160162</b>	<b>3431542160162</b>
XF-Bat 50 : Batterie 5.0 Ah - Battery 5.0 Ah	<b>3431542160193</b>	<b>3431542160193</b>
XF-Kit 15 : Batterie 1.5 Ah & chargeur rapide - Battery 1.5 Ah & charger	<b>3431542160179</b>	<b>3431542160179</b>
XF-Kit 15 : Batterie 4.0 Ah & chargeur rapide - Battery 4.0 Ah & charger	<b>3431542160185</b>	<b>3431542160185</b>
XF-Kit 15 : Batterie 5.0 Ah & chargeur rapide - Battery 5.0 Ah & charger	<b>3431542160353</b>	<b>3431542160353</b>

# Lampe de travail LED - LED torch - XF-Light

18 V  
100 Lm



**30** Une batterie unique pour  
**MACHINES**



Inclinable 7 positions  
7 Positions tilting head



LED Light



RUBBER Grip



- ▶ Eclairage LED 3W type COB  
LED Lighting 3W COB type
- ▶ Inclinable de 0 à 180° avec 7 positions  
Tilting head from 0 to 180° 7 positions
- ▶ 100 Lm  
100 Lm

Lampe de travail LED - LED torch	XF-Light	KIT XF-Light
Gencode	<b>3431542160087</b>	<b>3431546162087</b>
Tension et puissance de la batterie - Battery voltage and power	<b>18 V</b>	<b>18 V - 1.5 Ah</b>
Kit batterie / chargeur Battery / charger kit	<b>Sans batterie ni chargeur</b> Without battery nor charger	<b>1 batterie 1.5 Ah &amp; chargeur</b> 1.5 Battery & charger
Temps de charge indicatif - Indicative charge time	-	<b>40 min</b>
Puissance - Power	<b>3 W</b>	<b>3 W</b>
Puissance d'éclairage - Lighting power	<b>100 Lm</b>	<b>100 Lm</b>

Données logistiques - Logistic informations

Box 117x85x180 mm | Master 25 x 0,45 kg | Pal 350 | Ctr 20ft 12375 pcs



Consommables - Consumables

XF-Bat 15 : Batterie 1.5 Ah - Battery 1.5 Ah	3431542160155	3431542160155
XF-Bat 40 : Batterie 4.0 Ah - Battery 4.0 Ah	3431542160162	3431542160162
XF-Bat 50 : Batterie 5.0 Ah - Battery 5.0 Ah	3431542160193	3431542160193
XF-Kit 15 : Batterie 1.5 Ah & chargeur rapide - Battery 1.5 Ah & charger	3431542160179	3431542160179
XF-Kit 15 : Batterie 4.0 Ah & chargeur rapide - Battery 4.0 Ah & charger	3431542160185	3431542160185
XF-Kit 15 : Batterie 5.0 Ah & chargeur rapide - Battery 5.0 Ah & charger	3431542160353	3431542160353

DÉCAPAGE  
STRIPPING

ÉLECTROPORTATIF  
HANDPOWER TOOLS

X-FIT  
RANGE

ATELIER  
WORKSHOP

BOIS  
WOOD MACHINES

MÉTAL  
METAL MACHINES

NETTOYAGE  
CLEANING

MÉTIERS  
MANUAL WORK

JARDIN FILAIRE  
GARDEN TOOLS

Plus d'info sur  
**fartools.com**

## Batteries - Batteries - XF-Bat 15 / XF-Bat 40 / XF-Bat 50

18 V

1.5 Ah / 4.0 Ah / 5.0 Ah



Indicateurs de charge  
Charge indicators

- ▶ Indicateurs de charge  
Charge indicators
- ▶ Technologie Li-ion 18 Volts  
18 volts Li-ion technology
- ▶ Batterie 1.5 à 5.0 Ah  
Battery from 1.5 to 5.0 Ah

Batteries - Batteries	XF-Bat 15	XF-Bat 40	XF-Bat 50
Gencode	3431542160155	3431542160162	3431542160193
Tension/puissance de la batterie - Battery voltage and power	18 V - 1.5 Ah	18 V - 4.0 Ah	18 V - 5.0 Ah
Temps de charge indicatif - Indicative charge time	40 min	100 min	120 min
Données logistiques - Logistic informations			
Box 110x164x60 mm   Master 20 x 0,4 kg   Pal 600   Ctr 20ft 20160 pcs			
Box 107x165x80 mm   Master 20 x 0,65 kg   Pal 640   Ctr 20ft 15840 pcs			
Box 110x165x75 mm   Master 20 x 0,7 kg   Pal 320   Ctr 20ft 15840 pcs			

## Chargeur rapide & Batteries - Charger & Batteries XF-Kit 15 / XF-Kit 40

18 V

1.5 Ah / 4.0 Ah



Indicateurs de charge  
Charge indicators

- ▶ Indicateurs de charge  
Charge indicators
- ▶ Technologie Li-ion 18 Volts  
18 volts Li-ion technology
- ▶ Batterie 1.5 à 4.0 Ah  
Battery from 1.5 to 4.0 Ah

Chargeur rapide et batterie - Fast charger and battery	XF-Kit 15	XF-Kit 40
Gencode	3431542160179	3431542160186
Tension/puissance de la batterie - Battery voltage and power	18 V - 1.5 Ah	18 V - 4.0 Ah
Temps de charge indicatif - Indicative charge time	40 min	100 min
Données logistiques - Logistic informations		
Box 280x130x115 mm   Master 10 x 1,25 kg   Pal 200   Ctr 20ft 7560 pcs		
Box 300x135x115 mm   Master 10 x 1,5 kg   Pal 280   Ctr 20ft 5800 pcs		



# L'univers **Atelier**

Workshop

CAISSES - SERVANTES - ÉTAUX - PALANS - TREUILS



DÉCAPAGE  
STRIPPING

ÉLECTROPORATIF  
HANDPOWER TOOLS

X-FIT  
RANGE

ATELIER  
WORKSHOP

BOIS  
WOOD MACHINES

MÉTAL  
METAL MACHINES

NETTOYAGE  
CLEANING

MÉTIER  
MANUAL WORK

JARDIN FILAIRE  
GARDEN TOOLS

Plus d'info sur  
**fartools.com**

## Caisses de transport et rangement - Carrying and storage box

25 kg Max.

**NOUVEAU**

- ▶ Système de caisses empilables, par emboîtement  
System of boxes stackable, by nesting HAS
- ▶ Matériau : polymères résistants  
Material: durable polymers
- ▶ Supportent jusqu'à 25 kg  
Support up to 25 kg
- ▶ Indice de protection IP 54  
IP54 protection indice



## Boite à outils - Toolbox

23 Litres  
25 kg Max.



**NOUVEAU**



- ▶ Système de caisses empilables, par emboîtement  
System of boxes stackable, by nesting HAS
- ▶ Matériau : polymères résistants  
Material: durable polymers
- ▶ Supportent jusqu'à 25 kg  
Support up to 25 kg
- ▶ Indice de protection IP 54  
IP54 protection indice



Boite à outils - Tool box

Gencode **3431541160316**

Données logistiques - Logistic informations



3 431541 160316

Box 700x640x100 mm | Master 1 x 13,55 kg | Pal 20 | Ctr 20ft 625 pcs

## Caisse à outils - Toolbox

49 Litres  
25 kg Max.



**NOUVEAU**



- ▶ Deux séparateurs amovibles  
Two removable dividers
- ▶ Système de caisses empilables, par emboîtement  
System of boxes stackable, by nesting HAS
- ▶ Matériau : polymères résistants  
Material: durable polymers
- ▶ Supportent jusqu'à 25 kg  
Support up to 25 kg
- ▶ Indice de protection IP 54  
IP54 protection indice

Caisse à outils - Tool box

Gencode **3431541160323**

Données logistiques - Logistic informations



Box 1090x230x140 mm | Master 1 x 15,0 kg | Pal 21 | Ctr 20ft 888 pcs

Verrous robustes  
Strong lock

## Caisse à outils - Toolbox

64 Litres  
25 kg Max.



**NOUVEAU**



- ▶ Poignée télescopique et roues, pour transporter et ranger efficacement vos outils lors de vos chantiers  
Telescopic handle and wheels, to efficiently transport and store your tools during your construction sites
- ▶ Deux porte outils, deux séparateurs amovibles  
Two tool holders, two removable dividers
- ▶ Système de caisses empilables, par emboîtement  
System of boxes stackable, by nesting HAS
- ▶ Matériau : polymères résistants  
Material: durable polymers
- ▶ Supportent jusqu'à 25 kg  
Support up to 25 kg
- ▶ Indice de protection IP 54  
IP54 protection indice

Boîte à outils - Tool box

Gencode **3431541160330**

Données logistiques - Logistic informations



Box 450x380x380 mm | Master 1 x 15,0 kg | Pal 21 | Ctr 20ft 888 pcs

DÉCAPAGE  
STRIPPING

ÉLECTROPORATIF  
HANDPOWER TOOLS

X-FIT  
RANGE

ATELIER  
WORKSHOP

BOIS  
WOOD MACHINES

MÉTAL  
METAL MACHINES

NETTOYAGE  
CLEANING

MÉTIER  
MANUAL WORK

JARDIN FILAIRE  
GARDEN TOOLS

Plus d'info sur  
**fartools.com**

## Servante d'atelier - Work stand

700 - 1130 mm

100 kg Max.



- ▶ Patins anti glisse  
Anti slipping pads
- ▶ Hauteur réglable de 700 à 1130 mm  
Adjusting height from 700 to 1130 mm
- ▶ Diamètre de pied : 41,5 mm  
Foot diameter : 41,5 mm
- ▶ Charge maxi. : 100 kg  
Max. charge. : 100 kg

Servante d'atelier - Work stand

Gencode **3431541115002**

Données logistiques - Logistic informations



Box 625x150x100 mm | Master 6 x 5,5 kg | Pal 48 | Ctr 20ft 472 pcs

## Etabli pliant - Foldable work bench - WB 100SB

600 x 480 mm

100 kg Max.



- ▶ Pliable : encombrement réduit  
Foldable : space saving
- ▶ Hauteur de table ajustable au pied  
Adjustable table height at the foot
- ▶ Blocage / déblocage au pied  
Blocking / unblocking at the foot
- ▶ Table modulable pour divers outils  
Flexible table for various tools
- ▶ 4 ergots de maintien  
4 holding tabs

Etabli pliant - Foldable work bench

**WB 100SB**

Gencode **3431541200227**

Charge maximum - Maximum weight load

100 kg



Box 700x640x100 mm | Master 1 x 13,55 kg | Pal 20 | Ctr 20ft 625 pcs

# Servante d'atelier - Work stand - MTS 200B

1 m  
100 kg Max.

- ▶ Servantes ajustables supportant jusqu'à 100 kg  
Adjustable rollers supporting up to 100 kg
- ▶ Roues de transport  
Transportation wheels
- ▶ Système de fixation de la machine à verrouillage rapide (vis fournies)  
Fixing system for quick-locking machine (screws included)
- ▶ Table avec 4 pieds repliables pour un rangement facile.  
Table with 4 folding legs for easy storage.
- ▶ 2 extensions latérales avec rouleaux ajustables  
2 lateral extensions with adjustable rollers

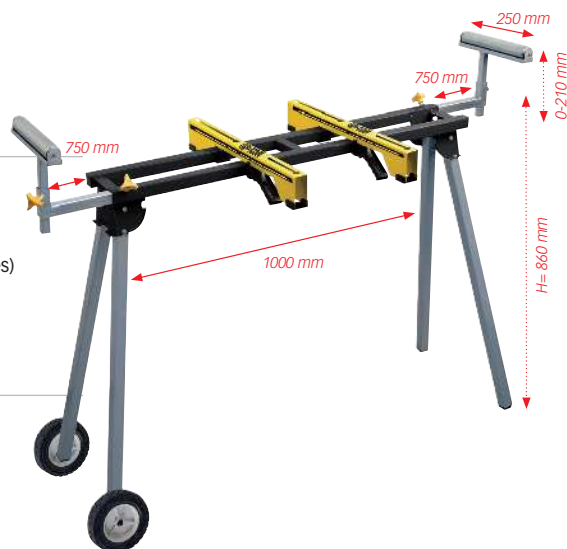
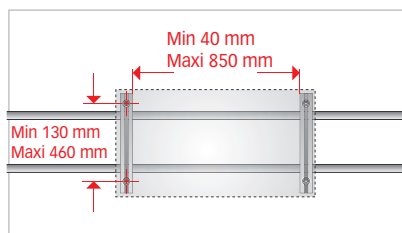

Servante d'atelier - Work stand

MTS 200B

Gencode 3431541200203

Données logistiques - Logistic informations



Box 1090x230x140 mm | Master 1 x 15,0 kg | Pal 21 | Ctr 20ft 888 pcs

DÉCAPAGE  
STRIPPING

ÉLECTROPORATIF  
HANDPOWER TOOLS

X-FIT  
RANGE

ATELIER  
WORKSHOP

BOIS  
WOOD MACHINES

MÉTAL  
METAL MACHINES

NETTOYAGE  
CLEANING

MÉTIER  
MANUAL WORK

JARDIN FILAIRE  
GARDEN TOOLS

Plus d'info sur  
**fartools.com**

## Etai d'établi en fonte - Iron bench vice - ETO 70

70 mm



- Base pivotante +/- 180°  
Rotative +/- 180°

Etai d'établi en fonte - Iron bench vice	<b>ETO 70</b>
Gencode	<b>3431541114531</b>
Longueur des mors - Jaw length	70 mm
Ouverture - Opening	40 mm
Base pivotante - Rotative base	360°
Données logistiques - Logistic informations	



Box 165x95x80 mm | Master 12 x 1,1 kg  
Pal 468 | Ctr 20ft 4040 pcs

## Etai d'établi en fonte - Iron bench vice - ETO 100

100 mm



**NOUVEAU**

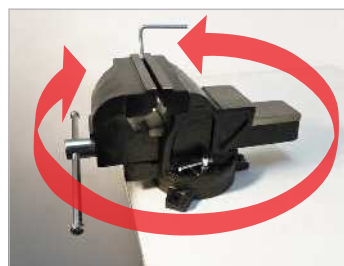

- Base pivotante +/- 180°  
Rotative +/- 180°

Etai d'établi en fonte - Iron bench vice	<b>ETO 100</b>
Gencode	<b>3431541114548</b>
Longueur des mors - Jaw length	100 mm
Ouverture - Opening	160 mm
Base pivotante - Rotative base	360°
Données logistiques - Logistic informations	



Box 405x210x215 mm | Master 1 x 12,2 kg  
Pal 35 | Ctr 20ft 1400 pcs

## Etai d'établi en fonte - Iron bench vice - ETO 125B

125 mm



- Base pivotante +/- 180°  
Rotative +/- 180°

Etai d'établi en fonte - Iron bench vice	ETO 125B
Gencode	<b>3431541114517</b>
Longueur des mors - Jaw length	125 mm
Ouverture - Opening	135 mm
Base pivotante - Rotative base	120° - 240° - 360°

### Données logistiques - Logistic informations



3 431541 1114517

Box 365x180x185 mm | Master 1 x 8,45 kg  
Pal 48 | Ctr 20ft 2330 pcs

## Etai d'établi en fonte - Iron bench vice - ETO 150

150 mm

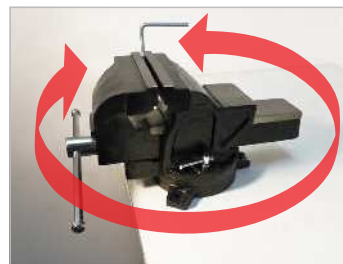

- Base pivotante +/- 180°  
Rotative +/- 180°

Etai d'établi en fonte - Iron bench vice	ETO 150
Gencode	<b>3431541114524</b>
Longueur des mors - Jaw length	150 mm
Ouverture - Opening	170 mm
Base pivotante - Rotative base	360°

### Données logistiques - Logistic informations



3 431541 1114524

Box 405x210x215 mm | Master 1 x 12,2 kg  
Pal 35 | Ctr 20ft 1400 pcs

DÉCAPAGE  
STRIPPING

ÉLECTROPORATIF  
HANDPOWER TOOLS

X-FIT  
RANGE

ATELIER  
WORKSHOP

BOIS  
WOOD MACHINES

MÉTAL  
METAL MACHINES

NETTOYAGE  
CLEANING

MÉTIER  
MANUAL WORK

JARDIN FILAIRE  
GARDEN TOOLS

Plus d'info sur  
**fartools.com**

## Support de perçage - Drill stand - DS 430B

80 mm

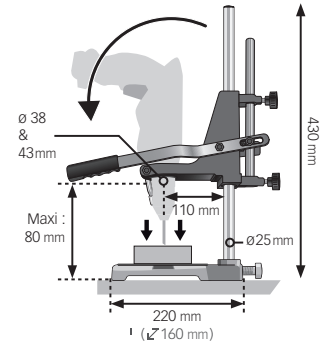

- ▶ Transforme votre perceuse en perceuse à colonne  
Turn your corded drill into a drill press
- ▶ Permet les perçages verticaux  
Allows vertical holes
- ▶ Fourni avec un anneau de réduction pour Ø 38 mm  
Supplied with a reduction ring for Ø 38 mm
- ▶ Ø 38 et 43 mm, hauteur totale : 430 mm,  
Profondeur de perçage : 80 mm  
Ø 38 & 43mm, total height: 430 mm,  
Drilling depth: 80 mm

Support de perçage - Drill stand

DS 430B

Gencode **3431541113008**

Données logistiques - Logistic informations



Box 75x100x535 mm | Master 10 x 2,5 kg | Pal 450 | Ctr 20ft 5600 pcs

## Ecrou de serrage universel - Universal clamp nut

M14



Livré en boîte distributrice de 20 unités  
Delivered in a dispenser box of 20 units



**ADAPTABLE**  
— AVEC LA PLUPART —  
**DES MEULEUSES**

- ▶ Universel  
Universal
- ▶ Toutes marques, tous diamètres et sans outil  
All brands, all diameters and without tool



Montage sans outil  
Mounting without tool

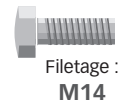
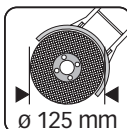
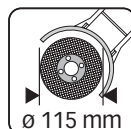

Filetage :  
M14

Ecrou de serrage universel - Universale clamp nut

Gencode **3431541101203**

Diamètre machines adaptables - Adaptable machine diameter

115 - 125 - 230 mm

Filetage - Thread

M14

Données logistiques - Logistic informations



Box 270x165x270 mm | Master 8,8 x 2 kg | Pal 40 | Ctr 20ft 2100 pcs



## Support pour meuleuse - Angle grinder stand - AGS 115-125

ø 115-125 mm



**ADAPTABLE**  
— AVEC LA PLUPART —  
DES MEULEUSES



Filetage :  
**M8 & M10**

- ▶ ø 115 - 125 mm,  
Adaptable avec la plupart des machines  
ø 115 - 125 mm,  
Adaptable with most machines

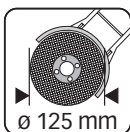
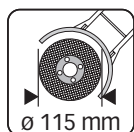

Support pour meuleuse - Angle grinder stand

**AGS 115-125**

Gencode **3431541113022**

Diamètre machines adaptables - *Adaptable machine diameter* 115 - 125 mm

Filetage - *Thread* M8 & M10

Données logistiques - *Logistic informations*



3 431541 1113022

Box 270x165x270 mm | Master 8,8 x 2 kg | Pal 40 | Ctr 20ft 2100 pcs

## Support pour meuleuse - Angle grinder stand - AGS 180-230

ø 180-230 mm



**ADAPTABLE**  
— AVEC LA PLUPART —  
DES MEULEUSES

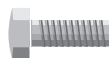
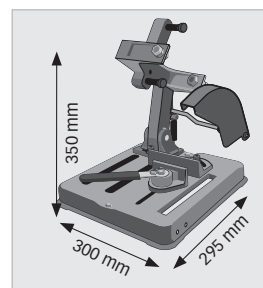

Filetage :  
**M12 & M14**

- ▶ ø 180 - 230 mm,  
Adaptable avec la plupart des machines  
ø 180 - 230 mm,  
Adaptable with most machines

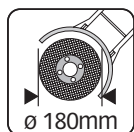

Support pour meuleuse - Angle grinder stand

**AGS 180-230**

Gencode **3431541113039**

Diamètre machines adaptables - *Adaptable machine diameter* 180 - 230 mm

Filetage - *Thread* M12 & M14

Données logistiques - *Logistic informations*



3 431541 1113039

Box 270x165x270 mm | Master 8,8 x 2 kg | Pal 40 | Ctr 20ft 2100 pcs

DÉCAPAGE  
STRIPPING

ÉLECTROPORATIF  
HANDPOWER TOOLS

X-FIT  
RANGE

ATELIER  
WORKSHOP

BOIS  
WOOD MACHINES

MÉTAL  
METAL MACHINES

NETTOYAGE  
CLEANING

MÉTIERS  
MANUAL WORK

JARDIN FILAIRE  
GARDEN TOOLS

Plus d'info sur  
**fartools.com**

## Treuil de halage - Winches hauling - TF 1000

**Câble 2,0 m**  
1000 kg

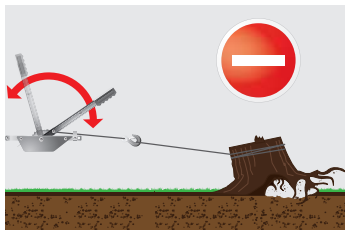

Ne pas utiliser ce produit pour du dessouchage !  
Stump removal prohibited !



\*450kg sur du travail en répétition  
\*450kg on repetitive works



- ▶ Poignée renforcée  
Reinforced handle
- ▶ Construction acier galvanisé = force et longévité  
Construction galvanized steel = strength and durability
- ▶ Doubles crochets 85 mm forgés, avec ressort sécurisé  
Double 85 mm hooks forged with secure spring
- ▶ Double cliquet robuste : enroulement par levier  
Double rugged ratchet : winding by lever

Treuil de halage - Winches hauling	TF 1000
Gencode	3431541820135
Dimension du câble - Steel cable sizes	ø 4 mm 2 m
Tambour / Bras de levier - Drum / Lever arm	ø 30 mm / 42 cm
Charge maxi - Maxi load	1000 kg*
Données logistiques - Logistic informations	



3 431541 820135

Box 75x100x535 mm | Master 10 x 2,5 kg | Pal 450 | Ctr 20ft 5600 pcs

## Treuil de halage - Winches hauling - TM 450

**10,0 m**  
450 kg



- ▶ Construction acier galvanisé  
Construction galvanized steel
- ▶ Rapport de transmission 4.2 : 1  
Gear ratio 4.2: 1
- ▶ Manivelle à double sens  
Crank two-way
- ▶ Cliquet réversible pour le débrayage de la bobine  
Reversible ratchet for the release of the coil

Treuil de halage - Winches hauling	TM 450
Gencode	3431541820142
Dimension du câble (recommandé) - Steel cable sizes (recommended) Non livré - Delivered without cable	ø 4 mm 10 m
Rapport de transmission - Gear ratio	4.2:1
Charge maxi / Charge de travail - Maxi load / maxi work load	450 / 360 kg
Données logistiques - Logistic informations	



3 431541 820142

Box 138x115x190 mm | Master 8 x 2,5 kg | Pal 450 | Ctr 20ft 6500 pcs

# Treuil de halage - Winches hauling - TE 907

9,0 m  
907 kg



Treuilage de véhicules  
Vehicle winching



Plaque pour attelage remorque  
Trailer coupling mounting plate steel



Halage de bateaux  
Boat hauling

- ▶ **Commande à distance**  
Remote control
- ▶ **Câble d'alimentation : 5 m**  
Power cable: 5 m
- ▶ **Petit et compact : idéal pour espaces restreints**  
Small and compact: ideal for restricted spaces
- ▶ **Parfait pour les ateliers, garages, fermes, usines...**  
Perfect for workshops, garages, farms, factories...

*Livré avec manivelle, pinces crocodile, support accroche remorque*  
Delivered with crank, alligator clips, trailer hanger bracket

Treuil de halage - Winches hauling	TE 907
Gencode	<b>3431541820159</b>
Puissance du moteur - Motor power (12 Vdc)	<b>300 W</b>
Vitesse à vide - No load speed	<b>1,8 m/min<sup>-1</sup></b>
Dimension du câble - Steel cable sizes	<b>ø 4,8 mm 9 m</b>
Tension fournie - Voltage supplied	<b>12 V</b>
Dimension crochet - Hook size	<b>1/4 "</b>
Charge maxi tirage - Maxi load	<b>907 kg</b>
Charge maxi marine - Maxi boat load	<b>2268 kg</b>
Charge maxi roulement - Maxi roll load	<b>2721 kg</b>
<b>Données logistiques - Logistic informations</b>	



Box 250x280x380 mm | Master 1 x 10,50 kg | Pal 120 | Ctr 20ft 902 pcs

DÉCAPAGE  
STRIPPING

ÉLECTROPORATIF  
HANDPOWER TOOLS

X-FIT  
RANGE

ATELIER  
WORKSHOP

BOIS  
WOOD MACHINES

MÉTAL  
METAL MACHINES

NETTOYAGE  
CLEANING

MÉTIERS  
MANUAL WORK

JARDIN FILAIRE  
GARDEN TOOLS

Plus d'info sur  
**fartools.com**

## Palan à chaîne - Chain hoist - CH 1T

2,5 m  
1 Tonne

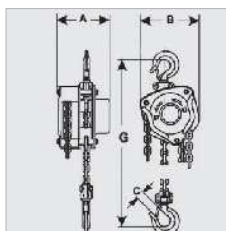

A	151
B	159
C	62
G (min)	315

- ▶ Frein de charge mécanique, roues pignons et arbres thermo-traités  
Mechanical brake
- ▶ 2 crochets orientables avec linguet de sécurité  
2 orientable hooks
- ▶ Chaîne en acier allié trempé  
Hardened alloy tool steel chain
- ▶ Crochet mousqueton  
Snap hook

Palan à chaîne - Chain hoist	<b>CH 1T</b>
Gencode	<b>3431541820081</b>
Charge maximum - Maximum weight load	1000 kg double mouflage
Hauteur de levage maxi - Maximum height	2,5 m

Données logistiques - Logistic informations



3 431541 820081

Box 250x190x150 mm | Master 1 x 13,0 kg | Pal 48 | Ctr 20ft 1200 pcs

## Palan à chaîne - Chain hoist - CH 2TB

2,5 m  
2 Tonnes

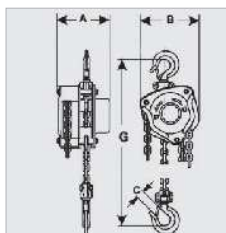

A	140
B	130
C	34
G (min)	400

- ▶ Frein de charge mécanique, roues pignons et arbres thermo-traités  
Mechanical brake
- ▶ 2 crochets orientables avec linguet de sécurité  
2 orientable hooks
- ▶ Chaîne en acier allié trempé  
Hardened alloy tool steel chain
- ▶ Crochet mousqueton  
Snap hook

Palan à chaîne - Chain hoist	<b>CH 2TB</b>
Gencode	<b>3431541820098</b>
Charge maximum - Maximum weight load	2000 kg double mouflage
Hauteur de levage maxi - Maximum height	2,5 m

Données logistiques - Logistic informations



3 431541 820098

Box 310x210x170 mm | Master 1 x 20,0 kg | Pal 48 | Ctr 20ft 1000 pcs

1,5 m  
1,5 T



- ▶ **Fonction palan et treuil (Vertical et horizontal)**  
Hoist and winches hauling functions (vertical & horizontal)
- ▶ **Idéal pour levage de charge < 1,5 Tonne (1500 kg)**  
Ideal for lifting loads < 1.5 Ton (1500 kg)
- ▶ **Fonction montée / descente**  
Up / down function
- ▶ **Crochet tournant à 360°**  
360° rotating hook
- ▶ **Frein automatique à double cliquet**  
Automatic double pawl brake

Palan à chaîne et levier - Chain hoist and lever	<b>PCL 1.5T</b>
Gencode	<b>3431541820630</b>
Charge maximum - Maximum weight load	1500 kg (1,5 T)
Longueur de chaîne - Chain length	1,5 m
Données logistiques - Logistic informations	



Box 449x180x170 mm | Master 1x10,5 kg | Pal 48 pcs | Ctr 20ft 2000 pcs

DÉCAPAGE  
STRIPPING

ÉLECTROPORATIF  
HANDPOWER TOOLS

X-FIT  
RANGE

ATELIER  
WORKSHOP

BOIS  
WOOD MACHINES

MÉTAL  
METAL MACHINES

NETTOYAGE  
CLEANING

MÉTIERS  
MANUAL WORK

JARDIN FILAIRE  
GARDEN TOOLS

Plus d'info sur  
**fartools.com**

# Palan électrique - Electric hoist - EP 500B

250 kg  
450 W

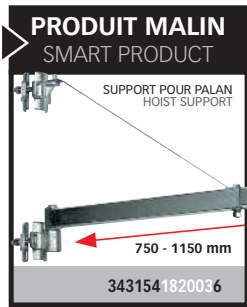

- ▶ **Moteur grande performance** | Standard GS = longévité de la machine  
High performance engine | Standard GS = machine longevity
- ▶ **Fixation pour installation sur potence**  
Fixing device for installation on bracket
- ▶ **Boîtier de commande (1,5 m)**  
Command case (1,5 m)
- ▶ **Arrêt d'urgence**  
Emergency stop
- ▶ **Crochet mouflage pour doubler la force de levage \***  
Hauling hook to double the lifting force \*

*Livré avec câble et télécommande*  
Delivered with cable and remote control



Palan électrique - Electric hoist		EP 500B
	Gencode	<b>3431541820029</b>
Puissance du moteur - Motor power (230V~50Hz) - 0,7 m		<b>450 W</b>
Charge maximum - Maximum weight		<b>250 kg *</b> <b>125 kg</b>
Vitesse à vide - No load speed		<b>4 m.min<sup>-1</sup></b> <b>8 m.min<sup>-1</sup></b>
Hauteur maximum - Maximum height		<b>6 m</b> <b>12 m</b>
Section du câble - Cable section		<b>ø : 3 mm</b>
Longueur câble télécommande - Remote control wire length		<b>1,5 m</b>
Données logistiques - Logistic informations		
 Box 410x100x255 mm   Master 4 x 2,87 kg   Pal 144   Ctr 20ft 1260 pcs		
Consommables - Consumables		
Support pour palan - Hoist support		<b>3431541820036</b>

# Palan électrique - Electric hoist - EP 400 2V

400 kg  
1000 W

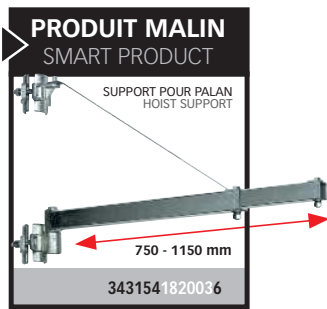

- ▶ **Moteur grande performance** | Standard GS = longévité de la machine  
High performance engine | Standard GS = machine longevity
- ▶ **Spécial: grande vitesse 7 et 14 m par minute**  
High speed version
- ▶ **Fixation pour installation sur potence**  
Fixing device for installation on bracket
- ▶ **Boîtier de commande (1,5 m)**  
Command case (1,5 m)
- ▶ **Arrêt d'urgence**  
Emergency stop
- ▶ **Crochet mouflage pour doubler la force de levage \***  
Hauling hook to double the lifting force \*

*Livré avec câble et télécommande*  
Delivered with cable and remote control



Palan électrique - Electric hoist	EP 400 2V
Gencode	<b>3431541820005</b>
Puissance du moteur - Motor power (230V~50Hz) - 0,7 m	<b>1000 W</b>
Charge maximum - Maximum weight	<b>400 kg *</b> <b>200 kg</b>
Vitesse à vide - No load speed	<b>7 m.min<sup>-1</sup></b> <b>14 m.min<sup>-1</sup></b>
Hauteur maximum - Maximum height	<b>10 m</b> <b>20 m</b>
Section du câble - Cable section	<b>ø : 4,0 mm</b>
Longueur câble télécommande - Remote control wire length	<b>1,5 m</b>
Données logistiques - Logistic informations	
 3 431541 820043   Box 410x100x255 mm   Master 4 x 2,87 kg   Pal 144   Ctr 20ft 1260 pcs	
Consommables - Consumables	
Support pour palan - Hoist support	<b>3431541820036</b>

DÉCAPAGE  
STRIPPING

ÉLECTROPORATIF  
HANDPOWER TOOLS

X-FIT  
RANGE

ATELIER  
WORKSHOP

BOIS  
WOOD MACHINES

MÉTAL  
METAL MACHINES

NETTOYAGE  
CLEANING

MÉTIER  
MANUAL WORK

JARDIN FILAIRE  
GARDEN TOOLS

Plus d'info sur  
**fartools.com**

# Palan électrique - Electric hoist - EP 1050B

600 kg  
1050 W

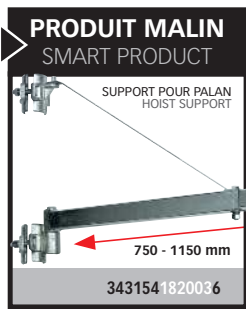

- ▶ **Moteur grande performance** | Standard GS = longévité de la machine  
High performance engine | Standard GS = machine longevity
- ▶ **Fixation pour installation sur potence**  
Fixing device for installation on bracket
- ▶ **Boîtier de commande (1,5 m)**  
Command case (1,5 m)
- ▶ **Arrêt d'urgence**  
Emergency stop
- ▶ **Crochet mouflage pour doubler la force de levage \***  
Hauling hook to double the lifting force \*

Livré avec câble et télécommande  
Delivered with cable and remote control



Palan électrique - Electric hoist		EP 1050B
	Gencode	<b>3431541820074</b>
Puissance du moteur - Motor power (230V~50Hz) - 0,7 m		<b>1050 W</b>
Charge maximum - Maximum weight		<b>600 kg *</b> <b>300 kg</b>
Vitesse à vide - No load speed		<b>4 m.min<sup>-1</sup></b> <b>8 m.min<sup>-1</sup></b>
Hauteur maximum - Maximum height		<b>6 m</b> <b>12 m</b>
Section du câble - Cable section		<b>ø : 4,5 mm</b>
Longueur câble télécommande - Remote control wire length		<b>1,5 m</b>
Données logistiques - Logistic informations		
 Box 410x100x255 mm   Master 4 x 2,87 kg   Pal 144   Ctr 20ft 1260 pcs		
Consommables - Consumables		
Support pour palan - Hoist support		<b>3431541820036</b>



L'univers

Wood machines range

# Stationnaire bois

TRAVAIL DU BOIS : COUPE - FAÇONNAGE - ASPIRATION...

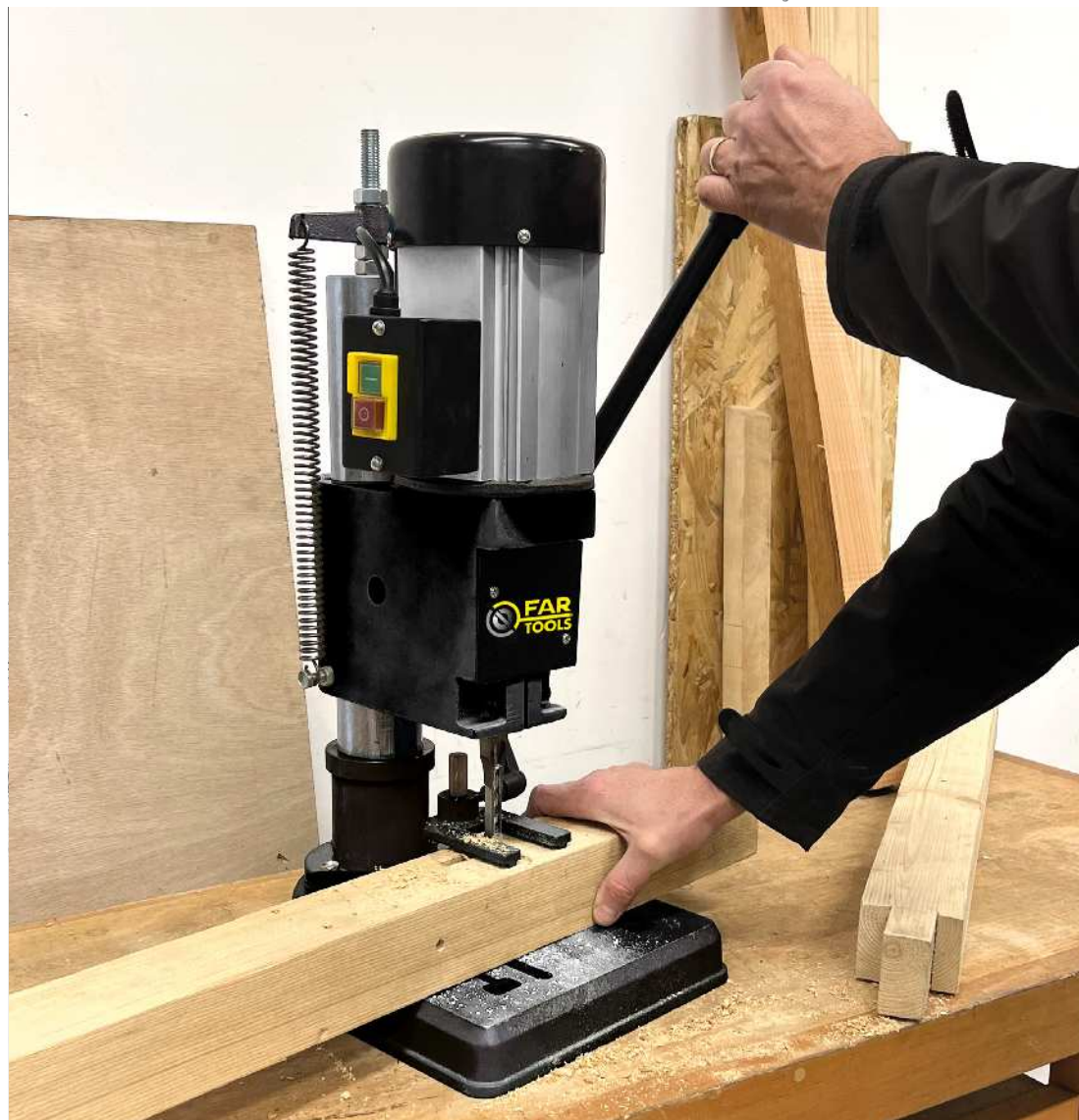

DÉCAPAGE  
STRIPPING

ÉLECTROPORTEFIF  
HANDPOWER TOOLS

X-FIT  
RANGE

ATELIER  
WORKSHOP

BOIS  
WOOD MACHINES

MÉTAL  
METAL MACHINES

NETTOYAGE  
CLEANING

MÉTIER  
MANUAL WORK

JARDIN FILAIRE  
GARDEN TOOLS

Plus d'info sur  
[fartools.com](http://fartools.com)

# Scie à onglet radiale multi-matériaux - Radial miter Saw - **SBM 210**

ø 210 mm  
1700 Watts



**PRODUIT MALIN**  
SMART PRODUCT

ADAPTEUR POUR ASPIRATEUR  
ADAPTER FOR VACUUM CLEANER

ø 40 mm  
ø 35,6 mm  
ø 32,4 mm  
ø 26,5 mm

3431541018518



Connexion à un aspirateur  
Vacuum cleaner connection



Lame spéciale bois et métaux  
Wood & metal special blade



Fonction radiale  
Radial function

- ▶ **Lame spéciale bois et métaux**  
Special blade for wood and metal
- ▶ **2 Vitesses de coupe**  
2 cutting speeds
- ▶ **Plateau indexable à l'avant = sécurité et confort pour trouver l'angle souhaité**  
Front indexable tray = safety and comfort to find the desired angle
- ▶ **Visée laser**  
Laser target
- ▶ **Fonction radiale**  
Radial function
- ▶ **Poignée de transport**  
Transportation handle
- ▶ **Blocage d'arbre**  
Arbor lock

Livrée avec 1 presse de serrage, 2 extensions de table avec supports, butées, sac à poussières et butée anti-bascule  
Delivered with clamping press, 2 table extensions with support, stops, dust bag & stabilization stop



**LASER**  
2x1,5V(AAA)



**Radiale**  
Sliding



**Multi-matériaux**  
Multi-materials

Scie à onglet radiale multi-matériaux - 8" Radial miter Saw		SBM 210
Gencode	343154 <b>1132139</b>	
Puissance du moteur - Motor power (230V-50Hz)	1700 W (S6)	
Diamètre / alésage de la lame - Blade diameter / bore	ø 210 / 25,4 mm	
Nombre de dents - Teeth number	36 T	
Vitesse de rotation Rotation speed	I: 3300 tr.min <sup>-1</sup> II: 5000 tr.min <sup>-1</sup>	
Capacité de coupe dans le bois Wood cutting capacities	 60x340 mm 32x340 mm 60x240 mm 32x240 mm	
Données logistiques - Logistic informations		
Box 790x460x350 mm   Master 1 x 15,0 kg   Pal 12 pcs   Ctr 20ft 210 pcs		
Consommables - Consumables		
Lame 36T multi matériaux - 36T multi materials blade		343154 <b>1139732</b>

# Scie à onglet radiale multi-matériaux - Radial miter Saw - SBM 255

ø 255 mm  
2000 Watts



## PRODUIT MALIN SMART PRODUCT

ADAPTATEUR POUR ASPIRATEUR  
ADAPTER FOR VACUUM CLEANER

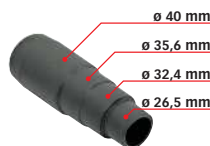

343154 10185 18



Connexion à un aspirateur  
Vacuum cleaner connection



Lame spéciale bois et métaux  
Wood & metal special blade



Fonction radiale  
Radial function

- ▶ **Lame spéciale bois et métaux**  
Special blade for wood and metal
- ▶ **2 Vitesses de coupe**  
2 cutting speeds
- ▶ **Plateau indexable à l'avant = sécurité et confort pour trouver l'angle souhaité**  
Front indexable tray = safety and comfort to find the desired angle
- ▶ **Visée laser**  
Laser target
- ▶ **Fonction radiale**  
Radial function
- ▶ **Poignée de transport**  
Transportation handle
- ▶ **Blocage d'arbre**  
Arbor lock

Livrée avec 1 presse de serrage, 2 extensions de table avec supports, butées, sac à poussières et butée anti-bascule  
Delivered with clamping press, 2 table extensions with support, stops, dust bag & stabilization stop



**LASER**  
2x1,5V(AAA)



**Radiale**  
Sliding



**Multi-matériaux**  
Multi-materials

Scie à onglet radiale-multi matériaux - 10" Radial miter Saw		SBM 255
Gencode	<b>3431541132184</b>	
Puissance du moteur - Motor power (230V-50Hz)	<b>2000 W (S6)</b>	
Diamètre / alésage de la lame - Blade diameter / bore	<b>ø 255 / 30 mm</b>	
Nombre de dents - Teeth number	<b>48 T</b>	
Vitesse de rotation Rotation speed	<b>I: 3200 tr.min<sup>-1</sup> II: 4800 tr.min<sup>-1</sup></b>	
Capacité de coupe dans le bois Wood cutting capacities	<b>78x310 mm 42x310 mm 78x210 mm 42x210 mm</b>	
Données logistiques - Logistic informations		
Box 760x460x395 mm   Master 1 x 20,0 kg   Pal 12 pcs   Ctr 20ft 210 pcs 3 431541 1132184		
Consommables - Consumables		
Lame 48T multi matériaux - 48T multi materials blade	<b>3431541139749</b>	

DÉCAPAGE  
STRIPPING

ÉLECTROPORATIF  
HANDPOWER TOOLS

X-FIT  
RANGE

ATELIER  
WORKSHOP

BOIS  
WOOD MACHINES

MÉTAL  
METAL MACHINES

NETTOYAGE  
CLEANING

MÉTIERS  
MANUAL WORK

JARDIN FILAIRE  
GARDEN TOOLS

Plus d'info sur  
**fartools.com**

# Scie de table réversible scie à onglet - FS 210

Flip over saw

Ø 210 mm  
1500 Watts

**NOUVEAU**



**PRODUIT MALIN**  
SMART PRODUCT

ADAPTEUR POUR ASPRATEUR  
ADAPTER FOR VACUUM CLEANER

- Ø 40 mm
- Ø 35,6 mm
- Ø 32,4 mm
- Ø 26,5 mm

34315410185 8

- ▶ **Une seule machine : 2 fonctions**  
One machine : 2 functions
- ▶ **Idéale pour de petits ateliers**  
Perfect for small workshops
- ▶ **Fonctions réversibles en moins de 5 secondes**  
Reversible in less than 5 seconds
- ▶ **Carter de protection transparent pour une parfaite visibilité**  
Transparent carter for better view
- ▶ **Buse d'aspiration des poussières**  
Dust collector
- ▶ **Lame inclinable de 0 à 45° et en hauteur de 0 à 50 mm**  
0 to 45° tilting blade, and adjusting cutting height 0 to 50 mm
- ▶ **Extension de table latérale repliable et ajustable**  
Foldable and adjustable lateral table extension
- ▶ **Machine compacte et transportable**  
Compact and transportable machine
- ▶ **Enrouleur de câble**  
Cable storage

Livrée avec guide parallèle, guide d'angle, poussoir et clef de serrage  
Delivered with parallel guide, angle guide, pushing bar and tightening wrench



Enrouleur de câble  
Cable storage



Guide d'angle  
Angle guide

Scie combinée - 8" Flip over saw	FS 210
Gencode	<b>3431541133556</b>
Puissance du moteur - Motor power (230V-50Hz)	<b>1500 W</b>
Diamètre / alésage de la lame - Blade diameter / bore	<b>Ø 210 / 25,4 mm</b>
Nombre de dents - Teeth number	<b>24 T</b>
Vitesse de rotation - Rotation speed	<b>5500 tr.min<sup>-1</sup></b>
Capacité de coupe dans le bois = Scie à onglet Wood cutting capacities = Mitre saw	<b>90° = 120x60 mm 45° = 80x60 mm</b>
Capacité de coupe dans le bois = Scie de table Wood cutting capacities = table saw	<b>90° = 50 mm</b>
Dimensions de table Table sizes	<b>375x430</b>
<b>Données logistiques - Logistic informations</b>	
Box 580x460x340 mm   Master 1 x 16,0 kg   Pal 18 pcs   Ctr 20ft 350 pcs	
<b>Consommables - Consumables</b>	
Lame 36T - 36T Blade	<b>3431541139732</b>

# Scie de table - Bench saw - TS 1200B

ø 210 mm  
1200 Watts



## PRODUIT MALIN SMART PRODUCT

ADAPTEUR POUR ASPIRATEUR  
ADAPTER FOR VACUUM CLEANER

ø 40 mm

ø 35,6 mm

ø 32,4 mm

ø 26,5 mm



3431541018518



Enrouleur de câble  
Cable storage



Guide d'angle  
Angle guide



Buse d'aspiration des poussières  
Dust collector

- ▶ **Idéale pour de petits ateliers**  
Perfect for small workshops
- ▶ **Carter de protection transparent pour une parfaite visibilité**  
Transparent carter for better view
- ▶ **Buse d'aspiration des poussières**  
Dust collector
- ▶ **Lame inclinable de 0 à 45° et en hauteur de 0 à 48 mm**  
0 to 45° tilting blade, and adjusting cutting height 0 to 48 mm
- ▶ **Extension de table latérale repliable et ajustable**  
Foldable and adjustable lateral table extension
- ▶ **Machine compacte et transportable**  
Compact and transportable machine
- ▶ **Enrouleur de câble**  
Cable storage

Livrée avec guide parallèle, guide d'angle, poussoir et clef de serrage  
Delivered with parallel guide, angle guide, pushing bar and tightening wrench

Scie de table - 8" Bench saw

TS 1200B

Gencode

3431541133662

Puissance du moteur - Motor power (230V-50Hz)

1200 W

Diamètre / alésage de la lame - Blade diameter / bore

ø 210 / 25,4 mm

Nombre de dents - Teeth number

24 T

Vitesse de rotation - Rotation speed

4800 tr.min<sup>-1</sup>

Capacité de coupe dans le bois  
Wood cutting capacities

90° = 48 mm  
45° = 42 mm

Dimensions de table  
Table sizes

400x525 mm  
+ 220x520 mm

Données logistiques - Logistic informations



Box 580x460x340 mm | Master 1 x 16,0 kg | Pal 18 pcs | Ctr 20ft 350 pcs

Consommables - Consumables

Lame 24T - 24T Blade

3431541138117

Lame 48T - 48T Blade

3431541138230

Lame 80T - 80T Blade

3431541138292

DÉCAPAGE  
STRIPPING

ÉLECTROPORATIF  
HANDPOWER TOOLS

X-FIT  
RANGE

ATELIER  
WORKSHOP

BOIS  
WOOD MACHINES

MÉTAL  
METAL MACHINES

NETTOYAGE  
CLEANING

MÉTIER  
MANUAL WORK

JARDIN FILAIRE  
GARDEN TOOLS

Plus d'info sur  
fartools.com

# Scie de table - Bench saw - TS 1800C

ø 250 mm  
1600 Watts



- ▶ **Table en aluminium**  
Aluminum table
- ▶ **Carter de protection transparent pour une parfaite visibilité**  
Transparent carter for better view
- ▶ **2 extensions de table latérale coulissantes en aluminium**  
2 sliding aluminum side table extensions
- ▶ **Livrée avec support et corps de machine monobloc**  
Delivered with a support and plastic body in one piece
- ▶ **Lame inclinable 0-45°**  
Tilting blade 0-45°
- ▶ **Réglage de la hauteur de coupe**  
Adjusting the cutting height
- ▶ **Range poussoir et lame supplémentaire intégrés au bâti**  
Pushing bar and additional blade storage integrated into the frame
- ▶ **Enrouleur de câble**  
Cable storage

*Livrée avec guide parallèle, guide d'angle, poussoir et butée anti-bascule*  
Delivered with parallel guide, angle guide, pushing bar and stabilization stop



Carter transparent  
Transparent carter



Guide d'angle  
Angle guide

Scie de table - 10" Bench saw		TS 1800C
Gencode		<b>3431541133990</b>
Puissance du moteur - Motor power (230V-50Hz)		<b>1600 W</b>
Diamètre / alésage de la lame - Blade diameter / bore		<b>ø 250 / 30 mm</b>
Nombre de dents - Teeth number		<b>36 T</b>
Vitesse de rotation - Rotation speed		<b>4800 tr.min<sup>-1</sup></b>
Capacité de coupe dans le bois Wood cutting capacities		<b>90° = 72 mm 45° = 50 mm</b>
Lame inclinable - Tilting blade		<b>0 - 45°</b>
Dimensions de table Table sizes		<b>545x625 mm + 2x (85x625) mm</b>
<b>Données logistiques - Logistic informations</b>		
Box 625x432x865 mm   Master 1 x 21,5 kg   Pal 8 pcs   Ctr 20ft 200 pcs		
<b>Consommables - Consumables</b>		
Lame 36T - 36T Blade		<b>3431541137981</b>

# Scie à ruban - Band saw - RBS 250C

1712 mm  
500 Watts

**PRODUIT MALIN**  
SMART PRODUCT

ADAPTEUR POUR ASPIRATEUR  
ADAPTER FOR VACUUM CLEANER

ø 40 mm  
 ø 35,6 mm  
 ø 32,4 mm  
 ø 26,5 mm

343154 10185 18



- ▶ **Molette de réglage de tension de lame = adapter la coupe à la densité du bois**  
Blade tension adjustment knob = adjusts the cutting to the density of the wood
- ▶ **Table inclinable = offre toutes les coupes d'angles possibles**  
Tilt table = offers all possible angle cuts
- ▶ **Buse d'aspiration = travail propre et sécurisé**  
Suction nozzle = clean and secure work
- ▶ **Avec support piétement large pour une meilleure stabilité et un travail en hauteur**  
With wide feet support for better stability and high work

*Livrée avec support, guide parallèle et poussoir*  
Delivered with stand, parallel guide and pushing bar



Molette de tension de lame  
Blade tension adjustment knob



Guide parallèle et poussoir  
Parallel guide and pushing bar

Scie à ruban - 10" Band saw	RBS 250C
Gencode	3431541132917
Puissance du moteur - Motor power (230V-50Hz)	500 W
Dimensions de la lame - Blade sizes	1712x10x1 mm
Nombre de dents - Teeth number	6 TPI
Vitesse de rotation Rotation speed	1400 tr.min <sup>-1</sup> 13m.s <sup>-1</sup>
Capacité de coupe maxi - Maximum cutting capacities	115 x 245 mm
Table inclinable - Tilting table	0 - 45°
Dimensions de table - Table sizes	302 x 304 mm
Niveau de bruit - Noise level (dB)	77,4-90,4 (+/- 3.0)
Données logistiques - Logistic informations	
Box 880x440x340 mm   Master 1 x 30,0 kg   Pal 6 pcs   Ctr 20ft 192 pcs	
Consommables - Consumables	
Lame 15 TPI 1712x8,4x0,35 mm - 15 TPI Blade	3431541138186
Lame 15 TPI 1712x10x1 mm - 15 TPI Blade	3431541137998

DÉCAPAGE  
STRIPPING

ÉLECTROPORATIF  
HANDPOWER TOOLS

X-FIT  
RANGE

ATELIER  
WORKSHOP

BOIS  
WOOD MACHINES

MÉTAL  
METAL MACHINES

NETTOYAGE  
CLEANING

MÉTIERS  
MANUAL WORK

JARDIN FILAIRE  
GARDEN TOOLS

Plus d'info sur  
fartools.com

# Scie à chantourner - Scroll saw - PSL 120B

127 mm  
120 Watts



- ▶ Démarrage au pied = mains libres  
Starting at the foot = hands free
- ▶ Carter de protection transparent pour une parfaite visibilité  
Transparent carter for better view
- ▶ Piétement pour travail à la bonne hauteur  
Base for working at the right height
- ▶ Table en fonte d'aluminium Ultra-rigide  
Ultra-rigid cast aluminum table
- ▶ Table inclinable 0 à 45°, Col de cygne de 406 mm  
0 to 45° tilting table, Distance between blade and support : 406 mm
- ▶ Chantournage précis avec éclairage et souffleur  
Jigsawing with light and blowing
- ▶ Variateur de vitesse de 400 à 1600 tr/min  
Speed variator from 400 to 1600 rpm

*Livrée avec son support, lampe, souffleur et une lame*  
Delivered with support, lighting system, blower and one blade



Démarrage au pied  
Foot start



Eclairage LED  
LED Light

Scie à chantourner - 16" Scroll saw		PSL 120B
	Gencode	<b>3431541132689</b>
Puissance du moteur - Motor power (230V~50Hz)		<b>120 W (S2)</b>
Dimensions de la lame - Blade sizes		<b>127 mm</b>
Vitesse de rotation - Rotation speed		<b>400 - 1600 tr.min<sup>-1</sup></b>
Capacité de coupe maxi - Maximum cutting capacities		<b>406 x 45 mm</b>
Table inclinable - Tilting table		<b>0 - 45°</b>
Dimensions de table - Table sizes		<b>252 x 413 mm</b>
Niveau de bruit - Noise level (dB)		<b>78 - 91 (+/- 3.0)</b>

#### Données logistiques - Logistic informations

3 431541132689 | Box 720x320x420 mm | Master 1 x 19,70 kg | Pal 12 pcs | Ctr 20ft 280 pcs

#### Consommables - Consumables

4 Lames (2 x 10 + 2 x 15 TPI) - Blades	<b>3431541138032</b>
4 Lames (2 x 24 + 2 x 18 TPI) - Blades	<b>3431541138100</b>
4 Lames hélicoïdales - Helicoid blades	<b>3431541138131</b>
Adaptateur universel - Universal Adaptator	<b>3431541137806</b>



# Combiné ponceur - Belt and disc sander - BDS 150

100x915 mm / ø 150 mm

370 Watts



Bras inclinable à 90°  
90° Tilting arm



Table inclinable 0-45°  
0-45° Tilting table

- ▶ **Bras de ponçage inclinable de 0 à 90°**  
Adjustable sanding arm from 0 to 90°
- ▶ **Bras et bâti en fonte = grande stabilité**  
Cast iron body and bench = high stability
- ▶ **Table Aluminium**  
Aluminium table
- ▶ **Table adaptable = offre toutes les orientations et angles pour le ponçage**  
Adaptable table = offers all orientations and angles for sanding

*Livrée avec un disque et une bande*  
Delivered with an abrasive belt and an abrasive disc

Combiné ponceur - Belt & disc sander	<b>BDS 150</b>
Gencode	<b>3431541132030</b>
Puissance du moteur - Motor power (230V-50Hz)	<b>370 W</b>
Dimensions de la bande - Belt sizes	<b>100 x 915 mm</b>
Diamètre du disque - Disc diameter	<b>ø 150 mm</b>
Vitesse de rotation Rotation speed	<b>2850 tr.min<sup>-1</sup> 8,3 m.s<sup>-1</sup></b>
Bras inclinable - Tilting arm	<b>0 - 90°</b>
Dimensions de table - Table sizes	<b>225 x 125 mm ALU</b>

#### Données logistiques - Logistic informations

3 431541 132030 | Box 570x275x315 mm | Master 1 x 19,70 kg | Pal 24 pcs | Ctr 20ft 520 pcs

#### Consommables - Consumables

6 disques A120/A80/A40 - 6 Discs	<b>3431541132597</b>
2 Bandes A120 - 2 Belts	<b>3431541133600</b>
2 Bandes A80 - 2 Belts	<b>3431541133617</b>
2 Bandes A40 - 2 Belts	<b>3431541133624</b>

DÉCAPAGE  
STRIPPING

ÉLECTROPORTATIF  
HANDPOWER TOOLS

X-FIT  
RANGE

ATELIER  
WORKSHOP

BOIS  
WOOD MACHINES

MÉTAL  
METAL MACHINES

NETTOYAGE  
CLEANING

MÉTIER  
MANUAL WORK

JARDIN FILAIRE  
GARDEN TOOLS

Plus d'info sur  
**fartools.com**

# Raboteuse dégauchisseuse - Planer thicknesser - PTH 254B

254 mm  
1500 Watts



- ▶ **Grande largeur de travail = 254 mm**  
Large working width = 254 mm
- ▶ **Carter collecteur pour aspirateur, utilisable pour rabot et dégauchisseuse**  
Collector housing for vacuum cleaner, usable for planer and thicknesser
- ▶ **Piètement pour travail à la bonne hauteur**  
Base for working at the right height
- ▶ **Réglage micrométrique de la passe**  
Micrometric adjustment of the cut
- ▶ **Table en Aluminium**  
Aluminium table
- ▶ **Cylindre porte fer : x 2**  
2 blades on the cylinder

*Livrée avec son support et 2 patins poignées de sécurité*  
Delivered with its support and 2 security pads



Fonction dégauchissage  
Thicknesser function



Fonction raboteuse  
Planer function

Raboteuse dégauchisseuse - 10" Planer thicknesser		PTH 254B
Gencode	3431541137578	
Puissance du moteur - Motor power (230V-50Hz)	1500 W	
Capacité de coupe maxi rabot - Planer maximum cutting capacities Passe - Cutting height	7-120 x 254 mm 0-2 mm	
Capacité de coupe maxi dégauchissage - Thicknesser maximum cutting capacities Passe - Cutting height	254 mm 0-2,5 mm	
Vitesse de rotation Rotation speed	9000 tr.min <sup>-1</sup> 6 m.s <sup>-1</sup>	
Dimensions de table rabot / dégauchissage Table sizes for planer / thicknesser	270x265 mm 920x265 mm	
Données logistiques - Logistic informations		
3 431541 1137578   Box 1027x508x433 mm   Master 1 x 33,50 kg   Pal 6 pcs   Ctr 20ft 110 pcs		
Consommables - Consumables		
Jeu de 2 fers réversibles 258x22x2,0 mm - 2 reversible blades		3431541139565

# Tour à bois - Wood lathe - TBF 1000

900 mm  
550 Watts

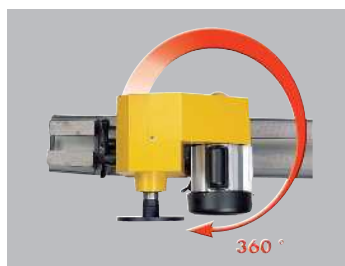

Moteur rotatif 360°  
Rotary motor 360°



Plateau de tournage  
turn plate

- ▶ **Rotation à 360° = permet de tourner de gros diamètres**  
Rotation at 360° = allows you to rotate large diameters
- ▶ **Puissante = grande qualité de réalisation**  
Powerful = high performance quality
- ▶ **Support pour travail en hauteur = confort et sécurité**  
Support for work in height = comfort and safety
- ▶ **Variateur de vitesses mécanique**  
Mechanical variable speed
- ▶ **Banc en fonte = excellente rigidité, évite les vibrations**  
Cast iron bench = good rigidity, avoids vibrations

Livré avec plateau de tournage, 1 étagère, 2 pointes porte outils, support et accessoires  
Delivered with turn plate, 1 shelf, 2 points tool holder, support and accessories

Tour à bois - Wood lathe		TBF 1000
Gencode		<b>3431541132474</b>
Puissance du moteur - Motor power (230V-50Hz)		<b>550 W</b>
Variateur de vitesse électronique - Electronic variable speed		<b>450 - 2100 min<sup>-1</sup></b>
Capacité maximum de tournage Maximum turning capacity		<b>ø 300 mm 900 mm</b>
Filetage - Threading		<b>25,4 mm 1" (8 TPI)</b>
Cône morse - Morse type		<b>CM2 / MT2</b>

#### Données logistiques - Logistic informations

3 431541 132474  Box 1360x330x390 mm | Master 1 x 82,5 kg | Pal 6 | Ctr 20ft 172 pcs

#### Consommables - Consumables

Copieur - Copying device	3431541132498
Mandrin 4 mors concentriques - Chuck with 4 concentric jaws	3431541137011
Mandrin à mors réversibles - Reversible chuck with 4 independant jaws	3431541132573
8 Ciseaux à bois - 8 Wood chisels	3431541138155

DÉCAPAGE  
STRIPPING

ÉLECTROPORATIF  
HANDPOWER TOOLS

X-FIT  
RANGE

ATELIER  
WORKSHOP

BOIS  
WOOD MACHINES

MÉTAL  
METAL MACHINES

NETTOYAGE  
CLEANING

MÉTIER  
MANUAL WORK

JARDIN FILAIRE  
GARDEN TOOLS

Plus d'info sur  
**fartools.com**

**300 mm**  
250 Watts

## PRODUIT MALIN SMART PRODUCT

MANDRIN 4 MORS CONCENTRIQUES  
CHUCK WITH 4 CONCENTRIC JAWS



3431541137011

## PRODUIT MALIN SMART PRODUCT

8 CISEAUX À BOIS  
8 WOOD CHISELS



3431541138155

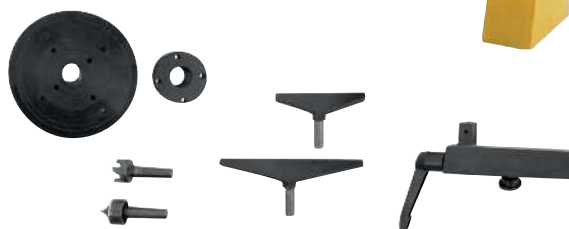

- ▶ **Compact = facilement transportable et pratique à ranger / stocker**  
Compact = easily portable and convenient for storing / storing
- ▶ **Puissante = grande qualité de réalisation**  
Powerful = high performance quality
- ▶ **Capacité de tournage : L 300 mm / ø 250 mm**  
Turning capacity: L 300 mm / ø 250 mm
- ▶ **Variateur de vitesses électronique**  
Electronic variable speed
- ▶ **Banc en fonte = excellente rigidité, évite les vibrations**  
Cast iron bench = good rigidity, avoids vibrations

Livré avec 1 contre pointe CM1, 1 broche d'entraînement CM1, 1 tige d'extraction, 1 plateau de tournage  
Delivered with 1 counter tip MT1, 1 4-pin, 1 extraction rod, 1 turning tray



**SPEED**  
Control

Tour à bois - Wood lathe		TBS 400B
	Gencode	<b>3431541132511</b>
Puissance du moteur - Motor power (230V-50Hz)		<b>250 W</b>
Variateur de vitesse électronique - Electronic variable speed		<b>750 - 3200 min<sup>-1</sup></b>
Capacité maximum de tournage Maximum turning capacity		<b>ø 200 mm 300 mm</b>
Filetage - Threading		<b>25,4 mm 1" (8 TPI)</b>
Cône morse - Morse type		<b>CM1 / MT1</b>
Données logistiques - Logistic informations		
Box 710x335x90 mm   Master 1 x 21 kg   Pal 21   Ctr 20ft 610 pcs		
Consommables - Consumables		
Mandrin 4 mors concentriques - Chuck with 4 concentric jaws		<b>3431541137011</b>
Mandrin à mors réversibles - Reversible chuck with 4 independant jaws		<b>3431541132573</b>
8 Ciseaux à bois - 8 Wood chisels		<b>3431541138155</b>



Créations fines et précises  
Fine and precise creations

## Mandrin 4 mors concentriques

Chuck with 4 concentric jaws

Ø 10-63 mm  
1" 8 Tpi



Livré avec adaptateur M 18  
Delivered with M18 adapter

Mandrin 4 mors concentriques Chuck with 4 concentric jaws	
Gencode	<b>3431541137011</b>
Ouverture - Opening	Ø 10 - 63 mm / M18
Type de filetage - Threading type	25,4 mm / 8TPI
Données logistiques - Logistic informations	
 Box 120x150x150 mm   Master 8 x 3,40 kg Pal 144   Ctr 20ft 13000 pcs	
Adaptable sur - Feet on	
113250 - 113251 - 113247	

## Mandrin à mors réversibles

Reversible chuck with 4 independant jaws

Ø 12-132 mm  
M18 / 1" 8 Tpi

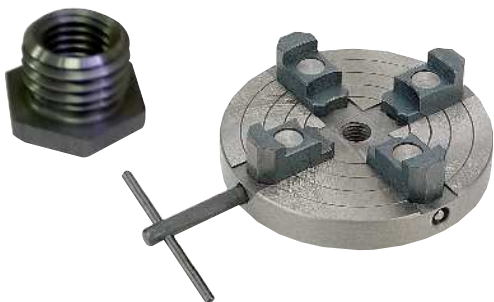

Livré avec adaptateur M 18/25,4  
Delivered with M18/25,4 adapter

Mandrin à mors réversibles Reversible chuck with 4 independant jaws	
Gencode	<b>3431541132573</b>
Ouverture - Opening	Ø 12 - 132 mm / M18
Type de filetage - Threading type	25,4 mm / 8TPI
Données logistiques - Logistic informations	
 Box 190x90x200 mm   Master 10 x 3,00 kg Pal 250   Ctr 20ft 8000 pcs	
Adaptable sur - Feet on	
113250 - 113251 - 113247	

## Copieur pour tour à bois

Wood lathe copying device

900 mm

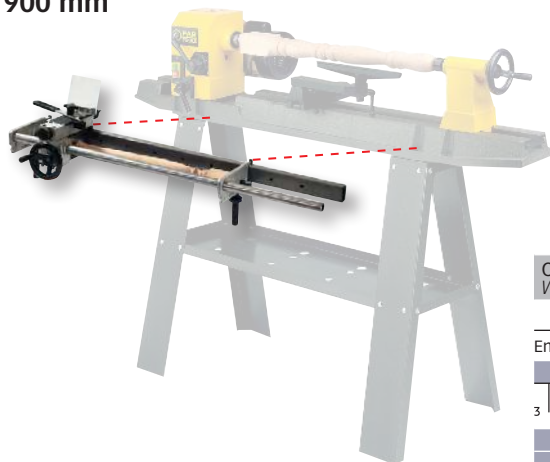

Copieur pour tour à bois Wood lathe copying device	
Gencode	<b>3431541132498</b>
Entraxe maximum - Maximum center distance	900 mm
Données logistiques - Logistic informations	
 Box 1800x2700x1080 mm   Master 1 x 15,90 kg Pal 21   Ctr 20ft 670 pcs	
Adaptable sur - Feet on	
113247	

DÉCAPAGE  
STRIPPING

ÉLECTROPORTATIF  
HANDPOWER TOOLS

X-FIT  
RANGE

ATELIER  
WORKSHOP

BOIS  
WOOD MACHINES

MÉTAL  
METAL MACHINES

NETTOYAGE  
CLEANING

MÉTIER  
MANUAL WORK

JARDIN FILAIRE  
GARDEN TOOLS

Plus d'infos sur  
**fartools.com**









Longueur développée	Largeur (mm)	DÉLIGNAGE		USAGE GÉNÉRAL	COUPE FINE MÉTAUX NON FERREUX	MACHINES CORRESPONDANTES
		4 TPI		6 TPI	15 TPI	
2240 mm	13		113825			113292
	16	113819				113292
1790 mm	6			113816		113291-2
	10			113828		113291-2
1712 mm	8,4			113799	113818	113291 / 113291-3
1425 mm	6,5			113805		113289
1400 mm	6				113806	113289-2
Length	Width (mm)	4 TPI		6 TPI	15 TPI	FEETS ON
		STRAIGHT CUTS		GENERAL USE	THIN CUT NON FERROUS METAL	



Sac papier Paper dust bag	Filtre cartouche Cartridge filter	Filtre mousse Foam filter	Filtre toile Fabric filter	MACHINES CORRESPONDANTES FEETS ON
101833	101809	101850		101027/101032
			101814	101256
	101862		101861	101256-2
101834	101819			101211
101822				101021/101026/101020
101833	101812	101850		101215
101827				101025/101031
		101846	101808	101210
	101818			101082
	101817			101081



	Dim.(mm) Sizes (mm)	  			MACHINES CORRESPONDANTES
		10 TPI	15 TPI	Multi	FEETS ON
	133x2,7x0,8	113803	113803		113254/113258/113260/113266/113268
	133x1,8x0,4		113810		113254
	133			113813	113254
	Adaptateur universel Universal Adaptor			 113780	113254



	Dim. / Sizes (mm)	Gencode	Pour / For:
 Réversible	258x22x2,0	3431541139565	PTH 254B (113757)

# Mortaiseuse a bédane carré - Mortiser - MS 3625B

90 mm  
500 Watts

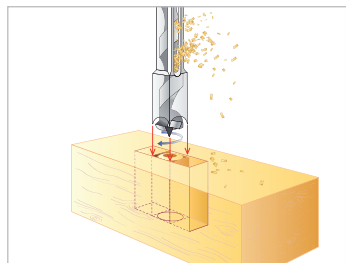
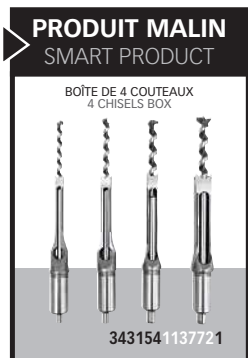

Capacités maxi 76 mm  
76 mm maximum capacities

- ▶ **Mécanisme de crémaillère**  
Mechanism of toothed rack
- ▶ **Bâti en fonte et acier**  
Iron and steel made base
- ▶ **Broche B16 pour ø 1 à 13 mm, queue ø 19 mm**  
B16 spindle from ø 1 to 13 mm, 19 mm diameter
- ▶ **Col de cygne 90 mm**  
Swan neck 90 mm



YouTube



Mortaiseuse a bédane carré - Mortiser	MS 3625B
Gencode	3431541137707
Puissance du moteur - Motor power (230V-50Hz)	500 W (S2)
Vitesse de rotation - Rotation speed	1440 tr.min <sup>-1</sup>
Profondeur de coupe - Cutting depth	90 mm
Dimensions de table - Table sizes	330 x 260 mm
Diamètre de mandrin Tools diameter	ø 13 mm B16
Données logistiques - Logistic informations	
3 431541 137707 Box 5360x300x700 mm   Master 1 x 28,85 kg   Pal 20 pcs   Ctr 20ft 270 pcs	
Consommables - Consumables	
Boîte de 4 copeaux ø 8/10/12/16 mm - 4 Chisels box	3431541137721

DÉCAPAGE  
STRIPPING

ÉLECTROPORTATIF  
HANDPOWER TOOLS

X-FIT  
RANGE

ATELIER  
WORKSHOP

BOIS  
WOOD MACHINES

MÉTAL  
METAL MACHINES

NETTOYAGE  
CLEANING

MÉTIERS  
MANUAL WORK

JARDIN FILAIRE  
GARDEN TOOLS

Plus d'info sur  
fartools.com

# Défonceuse sur table - Table electric router - MR 40PB

1500 Watts

DÉCAPAGE  
STRIPPING

ÉLECTROPORATIF  
HANDPOWER TOOLS

X-FIT  
RANGE

ATELIER  
WORKSHOP

BOIS  
WOOD MACHINES

MÉTAL  
METAL MACHINES

NETTOYAGE  
CLEANING

MÉTIER  
MANUAL WORK

JARDIN FILAIRE  
GARDEN TOOLS

Plus d'info sur  
**fartools.com**

-153-



Supports 18 outils intégrés  
18 integrated tools support



Table inclinable 0-45°  
0-45° Tilting table

- ▶ **Variateur de vitesse**  
Variable speed
- ▶ **Réglage de la course en face avant**  
Front depth adjustment
- ▶ **Réglage sans outils des butées anti-retour**  
Keyless adjustment of gauges
- ▶ **Bati en PVC moulé**  
Plastic construction base
- ▶ **Supports 18 outils intégrés**  
18 integrated tools support
- ▶ **Carter de protection transparent pour une parfaite visibilité**  
Transparent carter for better visibility
- ▶ **Vendeur muet**  
Mute seller



*Livrée avec guide d'angle et 3 peignes anti-rebond*  
*Delivered with 1 angle guide and 3 combs rebound stop*

Défonceuse sur table - Table electric router		MR 40PB
Gencode		<b>3431541134027</b>
Puissance du moteur - Motor power (230V-50Hz)		<b>1500 W</b>
Vitesse de rotation - Rotation speed		<b>8000-28000 tr.min<sup>-1</sup></b>
Profondeur de coupe - Cutting depth		<b>0 - 40 mm</b>
Dimensions de table - Table sizes		<b>600 x 460 mm</b>
Diamètre de pinces - Tools diameter		<b>ø 6/8/12 mm</b>
Données logistiques - Logistic informations		
3  431541134027   Box 630x490x400 mm   Master 1 x 20,00 kg   Pal 10 pcs   Ctr 20ft 200 pcs		
Consommables - Consumables		
Jeu de 12 fraises ø 8 mm - Cutters		<b>3431541158047</b>









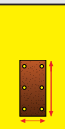
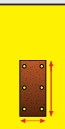

Tables de correspondance Consommables / Machines - Cross tables Consumables / Machines

LAMES - BLADES

	Aisilage (mm)	DELIGNAGE		COUPE STANDARD				COUPE FINE METAUX NON FERREUX	BOIS/METAUX	MACHINES CORRESPONDANTES
		24 Dents	36/40 T	30 Dents	36 Dents	48 Dents	60 Dents	80 Dents	Denture spéciale	
ø 110 mm	ø20								115838	115440
ø 185 mm	ø20	115832	115834							115436/115439/115437
ø 200 mm	ø20	113809								113365
ø 210 mm	ø25,4	113811			113973	113823		113829	113892	113211/113382/113366
	ø30									113393
ø 255 mm	ø16									113393
	ø25,4						113969			113385
	ø30				113798				113974	113393/113399
	Bore (mm)	24 Teeth	36/40 T			48 Teeth	60 Teeth	80 Teeth	Specific blade	FEETS ON
		DESTRIPPING		STANDARD CUT				THIN CUT NON FERROUS METAL	WOOD/METAL	

PAPIERS ABRASIFS - ABRASIVE PAPER

	Dim.(mm)	Réf.	DECAPAGE FORT	DECAPAGE	EGRENAGE	PONCAGE	FINITION			MACHINES CORRESPONDANTES
			GRAIN 40	GRAIN 60	GRAIN 80	GRAIN 120	GRAIN 150	GRAIN 180	GRAIN 240	
	117x228 (1/2)	115852 (1)	X							115160
		115853 (1)			X					
		115854 (1)					X			
	93x238 (1/3)	115868 (3)		X	X	X				115150/115155/715287 115135
	ø 125	115862 (1)	X							115152/115156
		115865 (1)			X					
		115866 (1)				X				
		115917 (1)			X	X		X		
	ø 150	113259 (2)	X		X	X				113200/113201/113203
	ø 180	115882 (1)	X							115167/115165
		115883 (1)		X						
		115884 (1)			X					
		115885 (1)				X				
		115877 (1)					X			
	ø 225	115895 (1)			X				X	115162/115159
		115896 (1)			X					
		115897 (1)				X				
		115898 (1)						X		
		115899 (1)							X	
115910 (1)			x 2		x 2		x 2			
	140x140x80	115859 (1)	X							115137/115136
		115860 (1)			X					
		115861 (1)				X				
	13x457	115880 (3)	X		X	X				115458
	40x760	115930 (3)				X				115025
		115931 (3)						X		
		115932 (3)							X	
		115933 (3)		X						
	100x914	115934 (3)			X					113200/113201/113202
		113360 (3)				X				
113361 (3)				X						
113362 (3)		X								
	Sizes (mm)		A 40	A 60	A 80	A 120	A 150	A 180	A 240	FEETS ON
			HARD STRIPPING	STRIPPING	SAND HARD	SANDING	FINISHING			

(1) Type auto agrippant (2) Type adhésif (3) Type standard  
 (1) Scratch type (2) Adhesive type (3) standard Type

L'univers

Metal machines range

# Stationnaire métal

TRAVAIL DU MÉTAL : MEULAGE - PERÇAGE - TRONÇONNAGE...



DÉCAPAGE  
STRIPPING

ÉLECTROPORTATIF  
HANDPOWER TOOLS

X-FIT  
RANGE

ATELIER  
WORKSHOP

BOIS  
WOOD MACHINES

MÉTAL  
METAL MACHINES

NETTOYAGE  
CLEANING

MÉTIERS  
MANUAL WORK

JARDIN FILAIRE  
GARDEN TOOLS

Plus d'info sur  
[fartools.com](http://fartools.com)

## Touret à meuler - Bench grinder - MBG 120B

Meule ø 75 mm / Meule brosse synthétique ø 75 mm  
120 Watts

**POLYVALENT**  
**MULTIPURPOSE**



Affûtage des petits outils  
Small tools sharpening



Flexible pour travail de finition  
Flexible for precision work

- ▶ **Variateur de vitesse** = tous matériaux et tous usages  
Speed variator = all materials and all uses
- ▶ **Polyvalent : meule, brosse à polir et flexible**  
Polyvalent: grinding, polishing brush & flexible
- ▶ Variateur de vitesse électronique  
Electronic variable speed
- ▶ Ecran polycarbonate haute résistance  
High strength polycarbonate screen
- ▶ Flexible connectable à l'arbre : travail précis  
Flexible connectable to the shaft : precise work

Touret à meuler - Bench grinder		MBG 120B
	Gencode	3431541101722
Puissance du moteur - Motor power (230V-50Hz)		120 W
Vitesse de rotation outil gauche - Left tool rotation speed		0-9900 tr.min <sup>-1</sup>
Dimensions outil gauche - Left tool sizes		75x20x10 mm A120
Vitesse de rotation outil droite - Right tool rotation speed		0-9900 tr.min <sup>-1</sup>
Dimensions outil droite - Right tool sizes		75x20x10 mm Fibre synthétique
Données logistiques - Logistic informations		
Box 255x150x165 mm   Master 4 x 2,50 kg   Pal 144   Ctr 20ft 3648 pcs		
Consommables page 166 - Consumables see page 166		

# Touret à meuler - Bench grinder - BGN 150C

Meule ø 150 mm / Meule ø 150 mm  
150 Watts



▶ Idéal pour les petits travaux d'affûtage / ébavurage / meulage  
Ideal for small sharpening/burring/Grinding

- ▶ Lampe LED et support d'outil  
LED light and tool rest
- ▶ Ecran polycarbonate haute résistance  
High strength polycarbonate screen



Eclairage de précision LED  
LED precision lighting

Touret à meuler - 6" Bench grinder	BGN 150C
Gencode	<b>3431541101814</b>
Puissance du moteur - Motor power (230V~50Hz)	<b>150 W</b>
Vitesse de rotation outil gauche - Left tool rotation speed	<b>2950 tr.min<sup>-1</sup></b>
Dimensions outil gauche - Left tool sizes	<b>150x12,7x16 mm A36</b>
Vitesse de rotation outil droite - Right tool rotation speed	<b>2950 tr.min<sup>-1</sup></b>
Dimensions outil droite - Right tool sizes	<b>150x12,7x16 mm A60</b>

Données logistiques - Logistic informations



Box 295x205x205 mm | Master 1 x 4,80 kg | Pal 98 | Ctr 20ft 2100 pcs

Consommables page 166 - Consumables see page 166

DÉCAPAGE  
STRIPPING

ÉLECTROPORATIF  
HANDPOWER TOOLS

X-FIT  
RANGE

ATELIER  
WORKSHOP

BOIS  
WOOD MACHINES

MÉTAL  
METAL MACHINES

NETTOYAGE  
CLEANING

MÉTIERS  
MANUAL WORK

JARDIN FLAIRE  
GARDEN TOOLS

Plus d'info sur  
**fartools.com**

# Touret à meuler - Bench grinder - BG 150C

Meule ø 150 mm / Meule ø 150 mm  
350 Watts

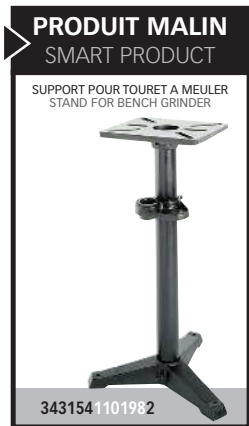

AFFÛTEUR DE FORETS  
DRILL SHARPENER



## INNOVATION



Affûteur de forets à métaux intégré  
Integrated metal drill Sharpener

- ▶ Puissance et précision = idéal pour les gros outils  
Power and precision = ideal for large tools
- ▶ Aiguiser de forets intégré pour forets à métaux  
Integrated metal drill bit sharpener
- ▶ Corps alu = meilleure diffusion de la chaleur  
Alu body = better heat diffusion
- ▶ Lampe LED et support d'outil  
LED light and tool rest
- ▶ Ecran polycarbonate haute résistance  
High strength polycarbonate screen
- ▶ Interrupteur magnétique de sécurité  
Safety magnetic switch

Livré avec meule grain A36 et meule grain A60  
Delivered with A36 grinder and A60 grinder



Idéal pour les gros outils  
Ideal for large tools

Touret à meuler - 6" Bench grinder	BG 150C
Gencode	3431541102507
Puissance du moteur - Motor power (230V-50Hz)	350 W (S2)
Vitesse de rotation outil gauche - Left tool rotation speed	2950 tr.min <sup>-1</sup>
Dimensions outil gauche - Left tool sizes	150x12,7x20 mm A36
Vitesse de rotation outil droite - Right tool rotation speed	2950 tr.min <sup>-1</sup>
Dimensions outil droite - Right tool sizes	150x12,7x20 mm A60

### Données logistiques - Logistic informations



Box 385x280x250 mm | Master 1 x 10,05 kg | Pal 54 | Ctr 20ft 1110 pcs

Consommables page 166 - Consumables see page 166

# Touret à meuler - Bench grinder - BG 200C

Meule ø 200 mm / Meule ø 200 mm  
400 Watts

DÉCAPAGE  
STRIPPING

ÉLECTROPORTATIF  
HANDPOWER TOOLS

X-FIT  
RANGE

ATELIER  
WORKSHOP

BOIS  
WOOD MACHINES

MÉTAL  
METAL MACHINES

NETTOYAGE  
CLEANING

MÉTIER  
MANUAL WORK

JARDIN FLAIRE  
GARDEN TOOLS

Plus d'info sur  
**fartools.com**

-159-

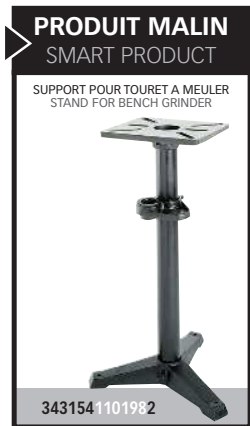

AFFÛTEUR  
DE FORETS  
DRILL  
SHARPENER



## INNOVATION



Affûteur de forets à métaux intégré  
Integrated metal drill Sharpener

- ▶ Haute performance = spécial travail en série et atelier  
High performance = special work in series and workshop
- ▶ Aiguiser de forets intégré pour forets à métaux  
Integrated metal drill bit sharpener
- ▶ Corps alu = meilleure diffusion de la chaleur  
Alu body = better heat diffusion
- ▶ Lampe LED et support d'outil  
LED light and tool rest
- ▶ Ecran polycarbonate haute résistance  
High strength polycarbonate screen
- ▶ Interrupteur magnétique de sécurité  
Safety magnetic switch

Livré avec meule grain A36 et meule grain A60  
Delivered with A36 grinder and A60 grinder



Idéal pour les gros outils  
Ideal for large tools

Touret à meuler - 8" Bench grinder	BG 200C
Gencode	3431541102408
Puissance du moteur - Motor power (230V-50Hz)	400 W (S2)
Vitesse de rotation outil gauche - Left tool rotation speed	2950 tr.min <sup>-1</sup>
Dimensions outil gauche - Left tool sizes	200x16x20 mm A36
Vitesse de rotation outil droite - Right tool rotation speed	2950 tr.min <sup>-1</sup>
Dimensions outil droite - Right tool sizes	200x16x20 mm A60

Données logistiques - Logistic informations



Box 390x290x285 mm | Master 1 x 14,20 kg | Pal 40 | Ctr 20ft 920 pcs

Consommables page 166 - Consumables see page 166

# Touret à meuler - Bench grinder - BGB 150D

Meule ø 150 mm / Meule Brosse ø 150 mm  
400 Watts

AFFÛTEUR  
DE FORETS  
DRILL  
SHARPENER



## PRODUIT MALIN SMART PRODUCT

SUPPORT POUR TOURET A MEULER  
STAND FOR BENCH GRINDER



3431541101982

## INNOVATION



Affûteur de forets à métaux intégré  
Integrated metal drill Sharpener

- ▶ 2 fonctions : **affûtage et décapage**  
2 functions: **sharpening and stripping**
- ▶ **Aiguseur de forets intégré pour forets à métaux**  
**Integrated metal drill bit sharpener**
- ▶ **Corps alu = meilleure diffusion de la chaleur**  
**Alu body = better heat diffusion**
- ▶ **Lampe LED et support d'outil**  
**LED light and tool rest**
- ▶ **Ecran polycarbonate haute résistance**  
**High strength polycarbonate screen**
- ▶ **Interrupteur magnétique de sécurité**  
**Safety magnetic switch**

Livré avec meule grain A36 et brosse de décapage  
Delivered with A36 grinder and stripping brush



LED  
Light



Meule spéciale décapage  
Stripping grinder

Touret à meuler - 6" Bench grinder	BGB 150D
Gencode	<b>3431541102552</b>
Puissance du moteur - Motor power (230V-50Hz)	<b>400 W</b>
Vitesse de rotation outil gauche - Left tool rotation speed	<b>2950 tr.min<sup>-1</sup></b>
Dimensions outil gauche Left tool sizes	<b>150x12,7x20 mm A36</b>
Vitesse de rotation outil droite - Right tool rotation speed	<b>2950 tr.min<sup>-1</sup></b>
Dimensions outil droite Right tool sizes	<b>150x12,7x12,7 mm</b>
Données logistiques - Logistic informations	
Box 476x210x255 mm   Master 1 x 7,8 kg   Pal 36   Ctr 20ft 1030 pcs	
Consommables page 166 - Consumables see page 166	



3 431541 102552

# Touret à meuler - Bench grinder - **SBG 150C**

Meule ø 150 mm / Bande 50 x 690 mm

350 Watts

DÉCAPAGE  
STRIPPING

ÉLECTROPORATIF  
HANDPOWER TOOLS

X-FIT  
RANGE

ATELIER  
WORKSHOP

BOIS  
WOOD MACHINES

MÉTAL  
METAL MACHINES

NETTOYAGE  
CLEANING

MÉTIER  
MANUAL WORK

JARDIN FILAIRE  
GARDEN TOOLS

Plus d'info sur  
**fartools.com**

AFFÛTEUR  
DE FORETS  
DRILL  
SHARPENER



## PRODUIT MALIN SMART PRODUCT

SUPPORT POUR TOURET A MEULER  
STAND FOR BENCH GRINDER



3431541101982

## INNOVATION



Affûteur de forets à métaux intégré  
Integrated metal drill Sharpener

- ▶ 2 fonctions : ponçage et affûtage  
2 functions: sanding and sharpening
- ▶ Aiguiser de forets intégré pour forets à métaux  
Integrated metal drill bit sharpener
- ▶ Corps alu = meilleure diffusion de la chaleur  
Alu body = better heat diffusion
- ▶ Lampe LED et support d'outil  
LED light and tool rest
- ▶ Ecran polycarbonate haute résistance  
High strength polycarbonate screen
- ▶ Interrupteur magnétique de sécurité  
Safety magnetic switch

Livré avec meule grain A60 et une bande de ponçage  
Delivered with A60 grinder and belt sander



LED  
Light



Fonction ponçage  
Sanding function

Touret à meuler - 6" Bench grinder	SBG 150C
Gencode	3431541102453
Puissance du moteur - Motor power (230V-50Hz)	350 W (S2)
Vitesse de rotation outil gauche - Left tool rotation speed	2950 tr.min <sup>-1</sup>
Dimensions outil gauche Left tool sizes	150x12,7x20 mm A60
Vitesse de rotation outil droite - Right tool rotation speed	15,5 m.s <sup>-1</sup>
Dimensions outil droite - Right tool sizes	50x690 mm

Données logistiques - Logistic informations



3 431541 102453

Box 443x393x260 mm | Master 1 x 8,50 kg | Pal 26 | Ctr 20ft 560 pcs

Consommables page 166 - Consumables see page 166



# Touret à meuler - Bench grinder - CBG 150/200D

Meule à eau ø 200 mm / Meule ø 150 mm  
350 Watts

AFFÛTEUR  
DE FORETS  
DRILL  
SHARPENER

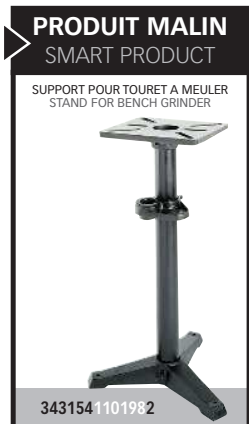

## INNOVATION



Affûteur de forets à métaux intégré  
Integrated metal drill Sharpener

- ▶ **Spécial aiguïsage** : précision et stabilité  
Special sharpening: precision and stability
- ▶ **Aiguiseur de forets intégré pour forets à métaux**  
Integrated metal drill bit sharpener
- ▶ **Corps alu** = meilleure diffusion de la chaleur  
Alu body = better heat diffusion
- ▶ **Lampe LED et support d'outil**  
LED light and tool rest
- ▶ **Ecran polycarbonate haute résistance**  
High strength polycarbonate screen
- ▶ **Interrupteur magnétique de sécurité**  
Safety magnetic switch

Livré avec meule grain A60 et meule à eau grain A80  
Delivered with A60 grinder and A80 water grinder



Meule à eau gr 80  
A80 water grinder

Touret à meuler - 8" & 6" Bench grinder	CGB 150/200D
Gencode	<b>3431541102354</b>
Puissance du moteur - Motor power (230V-50HZ)	<b>350 W</b>
Vitesse de rotation outil gauche - Left tool rotation speed	<b>140 tr.min<sup>-1</sup></b>
Dimensions outil gauche Left tool sizes	<b>200x12,7x40 mm A80</b>
Vitesse de rotation outil droite - Right tool rotation speed	<b>2950 tr.min<sup>-1</sup></b>
Dimensions outil droite Right tool sizes	<b>150x12,7x20 mm A36</b>

Données logistiques - Logistic informations



Box 472x308x307 mm | Master 1 x 9,7 kg | Pal 25 | Ctr 20ft 600 pcs

Consommables page 166 - Consumables see page 166

# Affûteur - Sharpener - W3S 200

Meule ø 200 mm / Meule cuir ø 200 mm  
120 Watts



«Affûtage rapide et précis.  
Meule solide et machine peu bruyante.»

Stéphane G.



Affûte tous vos outils :  
couteaux céramique, métal,  
lame de robot de tondeuse...  
All blade sharpening: Ceramic  
or metal knives, planer or lawnmower  
blades...



Bras de support, plus de précision  
Support arm, more precision



Disque de démorfilage en cuir  
Leather honing disc

- ▶ Variateur de vitesse  
Variable speed
- ▶ Inverseur de sens  
Wheel reversing control
- ▶ Réservoir d'eau amovible  
Removable water tank
- ▶ Couple réglable  
Adjustable torque
- ▶ Corps en injection plastique  
Plastic body
- ▶ Poignée de transport  
Carrying handle

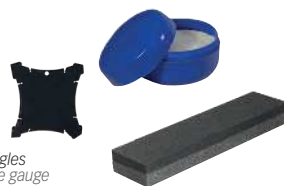

Livré avec pâte à graisser, pierre à polir et rapporteur d'angles  
Delivered with grinding stone, grease compound and angle gauge

YouTube



Affûteur - 8" Sharpener	W3S 200
Gencode	3431541101753
Puissance du moteur - Motor power (230V-50Hz)	120 W
Vitesse de rotation outil gauche - Left tool rotation speed	30-150 tr.min <sup>-1</sup>
Dimensions outil gauche Left tool sizes	200x12x40 mm A80
Vitesse de rotation outil droite - Right tool rotation speed	30-150 tr.min <sup>-1</sup>
Dimensions outil droite Right tool sizes	200x12x30 mm A36

Données logistiques - Logistic informations



3 431541 101753

Box 475x315x305 mm | Master 1 x 9,7 kg | Pal 30 | Ctr 20ft 721 pcs

Consommables page 166 - Consumables see page 166

DÉCAPAGE  
STRIPPING

ÉLECTROPORATIF  
HANDPOWER TOOLS

X-FIT  
RANGE

ATELIER  
WORKSHOP

BOIS  
WOOD MACHINES

MÉTAL  
METAL MACHINES

NETTOYAGE  
CLEANING

MÉTIERS  
MANUAL WORK

JARDIN FILAIRE  
GARDEN TOOLS

Plus d'info sur  
fartools.com

## Affûteur - Sharpener - AG 50

Meules ø 50 / ø 50 mm  
20 W



- ▶ **Facilité d'utilisation**  
Easy to use
- ▶ **2 niveaux de finition (ébauche-finition) pour un résultat professionnel**  
2 stages sharpening system for professional results at home
- ▶ **Angle d'aiguisage parfaitement respecté pour un guidage précis de la lame**  
Perfectly honed sharpening angle for precise blade guidance
- ▶ **Compact ; Aiguisage des couteaux métal & céramique**  
Compact ; Sharpening metal & ceramic knife

Affûteur - Sharpener	AG 50
Gencode	3431541101623
Puissance du moteur - Motor power (230V-50Hz)	20 W
Vitesse de rotation outil droite et gauche - Right and left tool rotation speed	3700 tr.min <sup>-1</sup>
Dimensions outil droite et gauche Right and left tool sizes	50 x 16 mm A80
Données logistiques - Logistic informations	
Box 500X260X360 mm   Master 8 x 1,30 kg   Pal 192   Ctr 20ft 5400 pcs	

3 431541 101623

## Affûteur de forets métal - Metal working drill - AFF 70B

95 W



- ▶ **20 diamètres de forets, de 3 à 12 mm**  
20 drills diameters, from 3 to 12 mm
- ▶ **Réglage de la finesse d'affûtage, pour des forets efficaces**  
Easy grinding stone settings, for more efficient drills

Affûteur - Sharpener	AFF 70B
Gencode	3431541101685
Puissance du moteur - Motor power (230V-50Hz)	95 W
Vitesse de rotation - Rotation speed	1500 tr.min <sup>-1</sup>
Données logistiques - Logistic informations	
Box 200x120x180 mm   Master 4 x 1,30 kg   Pal 180   Ctr 20ft 5418 pcs	

3 431541 101685

# Affûteur multi fonctions - Sharpener - AFM 65

Meule ø 48 mm

65 W



- ▶ **Multi fonctions**  
**Multi functions**
- ▶ **Idéal pour affûter forets, burins, ciseaux, couteaux, etc...**  
Perfect for drills, chisels, scissors, knives, etc...
- ▶ **Avec flexible mini meuleuse**  
Supplied with flexible for mini grinder accessories
- ▶ **Affûteur de Lames / burins (largeur de 6 à 51 mm)**  
Blade / chisel sharpener (width from 6 to 51 mm)
- ▶ **Ecran polycarbonate résistant**  
Resisting polycarb guard



Affûteur multi fonctions - Sharpener	AFM 65
Gencode	3431541101739
Puissance du moteur - Motor power (230V-50Hz)	65 W
Vitesse de rotation - Rotation speed	4800 tr.min <sup>-1</sup>
Dimensions meule Disc size	48 mm A80

Données logistiques - Logistic informations



3 431541 101739

Box 175x200x220 mm | Master 4 x 1,42 kg | Pal 96 | Ctr 20ft 3100 pcs

DÉCAPAGE  
STRIPPING

ÉLECTROPORTATIF  
HANDPOWER TOOLS

X-FIT  
RANGE

ATELIER  
WORKSHOP

BOIS  
WOOD MACHINES

MÉTAL  
METAL MACHINES

NETTOYAGE  
CLEANING

MÉTIERS  
MANUAL WORK

JARDIN FILAIRE  
GARDEN TOOLS

Plus d'info sur  
**fartools.com**

Kit d'adaptation universel - Universal adaptation set

Gencode **3431541108271**



3 431541 108271



Permet d'adapter tout alésage de meule ou brosse sur tout diamètre arbre  
To adapt any grinder or brush on any arbor size

Ø 32/25 - 32/20 - 32/16 - 25/20 - 20/18 - 20/16 - 20/12,7

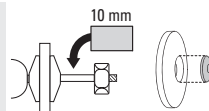

 A X B X C mm	MEULE CORINDON GRIS GRAY CORUNDUM GRINDER	MEULE CORINDON GRIS GRAY CORUNDUM GRINDER	CORINDON SUPERIEUR BLANC WHITE TOP GRADE CORUNDUM	CARBURE DE SILICIUM VERT GREEN SILICON CARBIDE
	<b>A 36</b>	<b>A 60</b>	<b>A 180</b>	<b>C 120</b>
150 X 12,7 X 20 mm	3431541108127	3431541108141		
150 X 32 X 20 mm				3431541108110
150 X 32 X 25 mm		3431541108028		
200 X 16 X 20 mm	3431541108165	3431541108189		
200 X 32 X 25 mm		3431541108059		
200 X 20 X 40 mm			3431541108103 (180)	
EBAVURAGE / MEULAGE CORDON DE SOUDURE DEBURRING / GRINDING SOLDERING LINE	☺ ☺ ☺	☺ ☺		
AFFUTAGE OUTILS DE JARDIN GARDEN TOOLS SHARPENING	☺	☺ ☺ ☺	☺ ☺	☺
AFFUTAGE COUTELLERIE KNIVES SHARPENING		☺	☺ ☺ ☺	☺ ☺
AFFUTAGE OUTILS CARBURE CARBIDE TOOLS SHARPENING				☺ ☺ ☺

2 BANDES ABRASIVES - 2 ABRASIVE BELTS

	A 120 690 x 50 mm	3431541108509
	A 80 690 x 50 mm	3431541108516
	A 40 690 x 50 mm	3431541108523
	Brosse fibre synthétique 75x20x10 mm	3431541108309
	Meule A 80 75x20x10 mm	3431541108318



 A X B X C mm	BROSSE LAITONÉE COATED WIRE BRUSH	
	150 X 32-16 X 20 mm	150 X 25 X 25 mm
SUR METAUX RIBBES ET BOIS ON METAL, STONE AND WOOD	DECAPAGE FORT SUR SURFACES RESISTANTES HARD STRIPPING ON RESISTING SURFACES	☺ ☺ ☺
	FORMES DIFFICILES DIFFICULT SHAPES	☺
	DECAPAGE SUR GRANDES SURFACES PLANES STRIPPING ON LARGE FLAT SURFACES	☺
	DECAPAGE ROUILLE ET PEINTURE RUST AND PAINT STRIPPING	☺

# Perceuse d'établi - Drill press - DPC 16E

**B16**  
350 Watts



700 mm

- ▶ **Etau fourni**  
Vice delivered
- ▶ **Carter poulies asservi**  
Belt carter servo control system
- ▶ **Table tournante**  
Turning table

*Livrée avec étau N° 2,5, 65 mm*  
*Delivered with N° 2.5 vice, 65 mm*



**STOP**  
ø1-16 mm



**+/- 180°**



**65 mm**  
N° 2,5



**Table**  
ø 165 mm

Perceuse d'établi - 4" Drill press	DPC 16E
Gencode	<b>3431541112025</b>
Puissance du moteur - Motor power (230V~50Hz)	<b>350 W ALU</b>
Vitesse de rotation Rotation speed	<b>620-2620 tr.min<sup>-1</sup> x 5</b>
Type de broche - Spindle	<b>B16</b>
Course de la broche - Spindle travel	<b>50 mm</b>
Col de cygne - Distance between spindle and column	<b>105 mm</b>
Diamètre de la colonne - Column diameter	<b>46 mm</b>
Capacité maxi de perçage avec CM - Maximum drilling capacity with MT	-
Hauteur totale - Total height	<b>700 mm</b>
Capacité maxi sur table - Maximum capacity on table	<b>355 mm</b>
Capacité maxi sur pied - Maximum capacity on foot	<b>270 mm</b>

Données logistiques - Logistic informations



3 431541 112025

Box 270x430x560 mm | Master 1 x 21,4 kg | Pal 20 | Ctr 20ft 610 pcs

Consommables page 173 - Consumables see page 173



Broche B 16  
Spindle B 16

# Perceuse d'établi - Drill press - DPB 25E

CM2/MT2  
550 Watts



1070 mm

- ▶ **Table ajustable par crémaillère**  
Adjustable table with toothed rack
- ▶ **Visée laser**  
Laser target
- ▶ **Etau fourni**  
Vice delivered
- ▶ **Cartier poulies asservi**  
Belt carter servo control system
- ▶ **Table tournante**  
Turning table

Livrée avec étau N°4, 100 mm  
Delivered with N°4 vice, 100 mm



Visée laser de précision  
Precision laser sighting

Perceuse d'établi - 6" Drill press	DPB 25E
Gencode	<b>3431541112070</b>
Puissance du moteur - Motor power (230V~50Hz)	<b>550 W ALU</b>
Vitesse de rotation Rotation speed	<b>180 - 2770 tr.min<sup>-1</sup> x 16</b>
Type de broche - Spindle	<b>CM2/MT2</b>
Course de la broche - Spindle travel	<b>85 mm</b>
Col de cygne - Distance between spindle and column	<b>162,5 mm</b>
Diamètre de la colonne - Column diameter	<b>72 mm</b>
Capacité maxi de perçage avec CM - Maximum drilling capacity with MT	<b>ø 22 mm</b>
Hauteur totale - Total height	<b>1070 mm</b>
Capacité maxi sur table - Maximum capacity on table	<b>610 mm</b>
Capacité maxi sur pied - Maximum capacity on foot	<b>420 mm</b>

Données logistiques - Logistic informations



Box 270x470x770 mm | Master 1 x 39,0 kg | Pal 7 | Ctr 20ft 320 pcs

Consommables page 173 - Consumables see page 173

DÉCAPAGE  
STRIPPING

ÉLECTROPORATIF  
HANDPOWER TOOLS

X-FIT  
RANGE

ATELIER  
WORKSHOP

BOIS  
WOOD MACHINES

MÉTAL  
METAL MACHINES

NETTOYAGE  
CLEANING

MÉTIER  
MANUAL WORK

JARDIN FILAIRE  
GARDEN TOOLS

Plus d'infos sur  
**far**tools.com

# Perceuse d'établi - Drill press - DPB 35E

**CM3/MT3**  
750 Watts



1060 mm

- ▶ **Table ajustable par crémaillère**  
Adjustable table with toothed rack
- ▶ **Visée laser**  
Laser target
- ▶ **Etau fourni**  
Vice delivered
- ▶ **Cartier poulies asservi**  
Belt carter servo control system
- ▶ **Table tournante**  
Turning table

Livrée avec étau N°4, 100 mm  
Delivered with N°4 vice, 100 mm



Perceuse d'établi - 7" Drill press		DPB 35E
	Gencode	<b>3431541112124</b>
Puissance du moteur - Motor power (230V~50Hz)		<b>750 W</b>
Vitesse de rotation Rotation speed		<b>180 - 2770 tr.min<sup>-1</sup> x 16</b>
Type de broche - Spindle		<b>CM3/MT3</b>
Course de la broche - Spindle travel		<b>85 mm</b>
Col de cygne - Distance between spindle and column		<b>176 mm</b>
Diamètre de la colonne - Column diameter		<b>80 mm</b>
Capacité maxi de perçage avec CM - Maximum drilling capacity with MT		<b>ø 32 mm</b>
Hauteur totale - Total height		<b>1060 mm</b>
Capacité maxi sur table - Maximum capacity on table		<b>550 mm</b>
Capacité maxi sur pied - Maximum capacity on foot		<b>375 mm</b>

Données logistiques - Logistic informations



Box 270x460x770 mm | Master 1 x 70,0 kg | Pal 7 | Ctr 20ft 260 pcs

Consommables page 173 - Consumables see page 173



Etau N°4, 100 mm  
N°4 vice, 100 mm



# Perceuse colonne - Floor drill press - DPC 25C

**CM2/MT2**  
550 Watts

1560 mm



- ▶ **Table ajustable par crémaillère**  
Adjustable table with toothed rack
- ▶ **Visée laser**  
Laser target
- ▶ **Étau fourni**  
Vice delivered
- ▶ **Cartier poulies asservi**  
Belt carter servo control system
- ▶ **Table tournante rainurée drainable**  
Turning table with recuperation tank and drain hole

Livrée avec étau N°4, 100 mm  
Delivered with N°4 vice, 100 mm



Table 250 x 250 mm  
250 x 250 mm table

Perceuse colonne - 6" Floor drill press		DPC 25C
	Gencode	<b>3431541112094</b>
Puissance du moteur - Motor power (230V~50Hz)		<b>550 W ALU</b>
Vitesse de rotation Rotation speed		<b>180 - 2770 tr.min<sup>-1</sup> x 16</b>
Type de broche - Spindle		<b>CM2/MT2</b>
Course de la broche - Spindle travel		<b>85 mm</b>
Col de cygne - Distance between spindle and column		<b>162,5 mm</b>
Diamètre de la colonne - Column diameter		<b>72 mm</b>
Capacité maxi de perçage avec CM - Maximum drilling capacity with MT		<b>ø 22 mm</b>
Hauteur totale - Total height		<b>1560 mm</b>
Capacité maxi sur table - Maximum capacity on table		<b>1095 mm</b>
Capacité maxi sur pied - Maximum capacity on foot		<b>550 mm</b>

Données logistiques - Logistic informations



3 431541 112094

Box 1100x450x270 mm | Master 1 x 60,0 kg | Pal 7 | Ctr 20ft 200 pcs

Consommables page 173 - Consumables see page 173

DÉCAPAGE  
STRIPPING

ÉLECTROPORATIF  
HANDPOWER TOOLS

X-FIT  
RANGE

ATELIER  
WORKSHOP

BOIS  
WOOD MACHINES

MÉTAL  
METAL MACHINES

NETTOYAGE  
CLEANING

MÉTIER  
MANUAL WORK

JARDIN FILAIRE  
GARDEN TOOLS

Plus d'infos sur  
**fartools.com**

**CM3/MT3**  
750 Watts

1580 mm



- ▶ **Table ajustable par crémaillère**  
Adjustable table with toothed rack
- ▶ **Visée laser**  
Laser target
- ▶ **Étau fourni**  
Vice delivered
- ▶ **Carter poulies asservi**  
Belt carter servo control system
- ▶ **Table tournante avec bac de récupération vidangeable**  
Turning table with recuperation tank and drain hole

Livrée avec étau N°4, 100 mm  
Delivered with N°4 vice, 100 mm



Perceuse colonne - 7" Floor drill press		DPC 35C
	Gencode	<b>3431541112186</b>
Puissance du moteur - Motor power (230V~50Hz)		<b>750 W</b>
Vitesse de rotation Rotation speed		<b>180 - 2770 tr.min<sup>-1</sup> x 16</b>
Type de broche - Spindle		<b>CM3/MT3</b>
Course de la broche - Spindle travel		<b>85 mm</b>
Col de cygne - Distance between spindle and column		<b>176 mm</b>
Diamètre de la colonne - Column diameter		<b>80 mm</b>
Capacité maxi de perçage avec CM - Maximum drilling capacity with MT		<b>ø 32 mm</b>
Hauteur totale - Total height		<b>1580 mm</b>
Capacité maxi sur table - Maximum capacity on table		<b>1070 mm</b>
Capacité maxi sur pied - Maximum capacity on foot		<b>595 mm</b>

Données logistiques - Logistic informations



Box 1140x490x270 mm | Master 1 x 80,0 kg | Pal 7 | Ctr 20ft 180 pcs

Consommables page 173 - Consumables see page 173



Broche CM3 / MT3  
Spindle CM3 / MT3

Mandrin auto-serrant MT2/CM2  
Keyless chuck MT2/CM2

1,5 / 13 mm

1,5 / 16 mm

Gencode **3431541114852 3431541114821**



Arbre  
Arbor

MT2/CM2 - B16

Gencode **3431541114838**



Mandrin 3 mors indépendants  
Chuck with 3 independent jaws

ø 125 mm

Gencode **3431541143159**



Adaptable sur - Feet on  
114070 - 114250 - 114135

Réducteur cone morse  
Morse taper reductor

CM2/MT2  
CM3/MT3

CM2/MT2  
CM4/MT4

CM4/MT4  
CM3/MT3

Gencode **3431541143524 3431541114876 3431541143562**



Coffret de tarauds et filières  
Taps and dies set

MT2/CM2

Gencode **3431541143708**



Poulie trapezoïdale  
Trapezoidal pulley

50 x 14 mm

50 x 24 mm

80 x 19 mm

80 x 24 mm

80 x 28 mm

120 x 19 mm

120 x 24 mm

120 x 28 mm

Gencode **3431541172203 3431541172302 3431541172401 3431541172456 3431541172654 3431541172553 3431541172609 3431541172708**



13x8 mm



Moteur - Motor				
Gencode	<b>3431541171060</b>	<b>3431541171114</b>	<b>3431541171169</b>	<b>3431541171411</b>
Puissance du moteur Motor power	1 CV (Alu) 736 W	2 CV (Alu) 1472 W	3 CV (Alu) 2208 W	3 CV (Alu) 2208 W
Vitesse de rotation / Nombre de pôles bobinage Rotation speed / Windings poles number	1500 min <sup>-1</sup> 4 P	1500 min <sup>-1</sup> 4 P	1500 min <sup>-1</sup> 4 P	3000 min <sup>-1</sup> 2 P
<b>V</b>	80 mm	90 mm	100 mm	90 mm
<b>W</b>	19 mm	24 mm	28 mm	24 mm
<b>X</b>	125 mm	140 mm	160 mm	140 mm
<b>Y</b>	100 mm	100 mm	140 mm	100 mm
<b>Z</b>	40 mm	50 mm	60 mm	50 mm

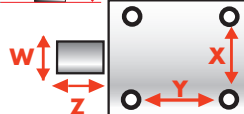
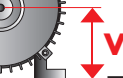
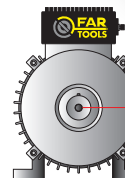

IP54 / Disjoncteur thermique - Thermal circuit breaker

Etaux - Vices

Gencode **3431541114593 3431541114616 3431541114623 3431541114630**

<b>A</b> Largeur des mors - Jaws width	65 mm	100 mm	125 mm	150 mm
<b>B</b> Profondeur des mors - Jaws depth	20 mm	20 mm	20 mm	20 mm
<b>C</b> Ouverture des mors - Jaws opening	56 mm	100 mm	125 mm	145 mm
<b>D</b> Entraxe - Distance between holes center	105 mm	135 mm	150 mm	185 mm
<b>N°</b> Type - Type	2,5	4	5	6

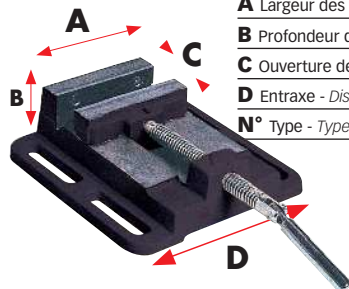

DÉCAPAGE  
STRIPPING

ÉLECTROPORATIF  
HANDPOWER TOOLS

X-FIT  
RANGE

ATELIER  
WORKSHOP

BOIS  
WOOD MACHINES

MÉTAL  
METAL MACHINES

NETTOYAGE  
CLEANING

MÉTIER  
MANUAL WORK

JARDIN FLAIRE  
GARDEN TOOLS

Plus d'info sur  
**far.tools.com**

L'univers

Cleaning range

# Nettoyage

NETTOYER - ASPIRER - DÉTACHER - VIDANGER



DÉCAPAGE  
STRIPPING

ÉLECTROPORATIF  
HANDPOWER TOOLS

X-FIT  
RANGE

ATELIER  
WORKSHOP

BOIS  
WOOD MACHINES

MÉTAL  
METAL MACHINES

NETTOYAGE  
CLEANING

MÉTIERS  
MANUAL WORK

JARDIN FILAIRE  
GARDEN TOOLS

Plus d'info sur  
[fartools.com](http://fartools.com)

# Station de nettoyage - Cleaning station - SN 500

1,7 L  
500 W

**PRODUIT MALIN**  
SMART PRODUCT

**DETERGENT PRO**  
PROFESSIONAL DETERGENT

Parfum léger  
Light fragrance

1 L  
= 30 m<sup>2</sup>

Formule spéciale  
professionnels  
special  
professional  
formula



**MADE IN FRANCE**

343154 1018808



Clip pour rangement du tuyau  
Hose storage clip



Embout d'aspiration transparent  
Transparent suction tip



Pratique dans les petits espaces  
Practice in small spaces

- ▶ **Puissance et efficacité : 11,5 kpa**  
Power and efficiency: 11.5 kpa
- ▶ **Très pratique pour les petits espaces (voitures, canapés, etc...)**  
Very practical for small spaces (cars, sofas, etc...)
- ▶ **Cuve plastique 1,7 L eau et détergent non moussant**  
Plastic tank 1.7 L water and detergent
- ▶ **Clip pour rangement du tuyau**  
Hose storage clip
- ▶ **Longueur du tuyau 1,5 m**  
Hose length 1,5 m

*Livré avec 1 suceur transparent pour petites surfaces + une brosse*  
*Delivered with 1 transparent nozzle for small surfaces + a brush*

**YouTube**



Station de nettoyage - Cleaning station	SN 500
Gencode	3431541010338
Puissance du moteur - Motor power (230V-50Hz)	500 W 11,5 kpa
Volume de la cuve - Tank volume	1,7 L eau & détergent 0,6 L eau sale
Longueur du tuyau - Hose length	1,5 m
Données logistiques - Logistic informations	
Box 460x350x345 mm   Master 1 x 5,0 kg   Pal NC   Ctr 20ft 510 pcs	
3 431541 010338	
Consommables - Consumables	
Shampooing moquette parfumé - Carpet shampoo	3431541018808

# Nettoyeur, shampooineuse, aspirateur eau et poussières

## Cleaner, shampoo, wet & dry Vacuum cleaner - SPO 20LB

18 kpa  
1200W



**PRODUIT MALIN**  
SMART PRODUCT

DETERGENT PRO  
PROFESSIONAL DETERGENT

Parfum léger  
Light fragrance

1 L = 30 m<sup>2</sup>

Formule spéciale professionnels  
Special professional formula

MADE IN FRANCE

3431541018808



- ▶ 4 en 1 : Aspiration eau / poussières / Soufflage / Shampooing
- ▶ 4 in 1: Water suction / dust / Blow / Shampoo
- ▶ Détergent injecté sous 2,3 Ba : idéal pour sols textiles et synthétiques
- ▶ Detergent injected under pressure 2.3 Bar: ideal for textile and synthetic floors
- ▶ Réservoir amovible 4 L : pour détergent / eau claire
- ▶ Removable tank 4 L: for detergent / clear water
- ▶ Réduit le temps de séchage du textile par 2
- ▶ Reduces the drying time of the textile by 2

Livré avec multiples accessoires  
Delivered with different accessories



x 4  
**Blowing**  
Souffleur



**4 in 1**



**WET&DRY**



Pratique dans les petits espaces  
Practice in small spaces



Idéal sols textiles  
Ideal textile floors

Nettoyeur, shampooineuse, aspirateur eau et poussières Cleaner, shampoo, wet & dry Vacuum cleaner	SPO 20LB
Gencode	<b>3431541012158</b>
Puissance du moteur - Motor power (230V-50Hz)	<b>1200 W</b> <b>18 kpa</b>
Volume de la cuve - Tank volume	<b>20 L</b> <b>Polypropylène</b>
Raccord tournant - Turning connector	<b>Ok</b>
Longueur du tuyau - Hose length	<b>ø 35 mm</b> <b>1,5 m</b>

Données logistiques - Logistic informations



Box 360x360x595 mm | Master 1 x 730 kg | Pal 16 | Ctr 20ft 345 pcs

Consommables - Consumables

Filtre cartouche - Cartridge filter	3431541018815
Sac à poussières - Dustbags	3431541018822
Filtre mousse (x3) - Foam filter	3431541018839
Shampooing moquette parfumé - Carpet shampoo	3431541018808

DÉCAPAGE  
STRIPPING

ÉLECTROPORATIF  
HANDPOWER TOOLS

X-FIT  
RANGE

ATELIER  
WORKSHOP

BOIS  
WOOD MACHINES

MÉTAL  
METAL MACHINES

NETTOYAGE  
CLEANING

MÉTIERS  
MANUAL WORK

JARDIN FILAIRE  
GARDEN TOOLS

Plus d'info sur  
**fartools.com**

# Aspirateur vide cendres - Ashes vacuum cleaner - APG 4

4 L  
600 Watts



**SPECIAL**  
poêles à granulés  
pellet stoves



**Format mini : cuve 4 L**  
**Mini format: 4 L tank**

Léger, facile à transporter et à ranger  
Light, easy to transport and store

**Accessoires inclus**  
**Accessories included**



Embout ALU  
ALU nozzle

- ▶ Autoaspirant  
Autosuction
- ▶ Cuve acier 4 L  
4 L steel tank
- ▶ Tube ø 32 mm aluminium  
Tube ø 32 mm aluminium
- ▶ Flexible 50 cm ø 38 mm  
Hose 50 cm ø 38 mm
- ▶ Poignée pour transport facile  
Handle for easy carrying

Livré avec filtre cartouche, un flexible, une rallonge aluminium et un embout  
Delivered with cartridge filter, a hose, an aluminium extension and a nozzle



Spécial poêle à granulés  
Special pellet stove

Aspirateur vide cendres - Ashes vacuum cleaner	APG 4
Gencode	3431541010840
Puissance du moteur - Motor power (230V-50Hz)	600 W 13 kpa
Volume de la cuve - Tank volume	4 L Acier
Longueur du tuyau - Hose length	ø 38 mm 0,5 m
Données logistiques - Logistic informations	
Box 250x225x225 mm   Master 0   Pal 84 pcs   Ctr 20ft 2370 pcs	
3 431541 010840	
Consommables - Consumables	
Filtre cartouche - Cartridge filter	3431541018631

# Aspirateur vide cendres - Ashes vacuum cleaner - AMF 18F

18 L  
800 Watts

**NOUVEAU**



Autoaspirant  
AutoSuction



XF-Ashes - 216032 - P 117



EXISTE AUSSI EN VERSION BATTERIE  
ALSO AVAILABLE IN BATTERY VERSION



Peu encombrant  
Compact



Aspiration des cendres pour BBQ  
Cold BBQ ashes aspiration



- ▶ **Fonction souffleur**  
Blower function
- ▶ **Moteur 800 W intégré**  
Integrated 800 W motor
- ▶ **Autoaspirant**  
AutoSuction
- ▶ **Cuve acier 18 L**  
18 L steel tank
- ▶ **Poignée pour faciliter le transport**  
Handle for easier carrying
- ▶ **Embout Alu**  
Aluminium nozzle
- ▶ **Tube 1 mètre ø 34 mm acier**  
1 meter ø 34 mm metal tube

Livré avec filtre cartouche et bonnette ignifugée  
Delivered with cartridge filter and flame retardant fabric cloth

**2 in 1**



Blowing  
Souffleur

Aspirateur vide cendres - Ashes vacuum cleaner	AMF 18F
Gencode	<b>3431541010819</b>
Puissance du moteur - Motor power (230V-50Hz)	<b>800 W</b> <b>16 kpa</b>
Volume de la cuve - Tank volume	<b>18 L</b> <b>Acier - Steel</b>
Longueur du tuyau - Hose length	<b>ø 34 mm</b> <b>1,0 m</b>
Données logistiques - Logistic informations	
3 431541 010819   Box 310x310x340 mm   Master 1 x 3,70 kg   Pal 30   Ctr 20ft 880 pcs	
Consommables - Consumables	
Filtre cartouche - Cartridge filter	<b>3431541018112</b>

DÉCAPAGE  
STRIPPING

ÉLECTROPORATIF  
HANDPOWER TOOLS

X-FIT  
RANGE

ATELIER  
WORKSHOP

BOIS  
WOOD MACHINES

MÉTAL  
METAL MACHINES

NETTOYAGE  
CLEANING

MÉTIERS  
MANUAL WORK

JARDIN FILAIRE  
GARDEN TOOLS

Plus d'info sur  
**fartools.com**



# Aspirateur vide cendres - Ashes vacuum cleaner - APG 15

15 L  
1000 Watts

**SPECIAL**  
poêles à granulés  
pellet stoves



Accessoires spécial poêle à granulés  
Special accessories for pellet stoves



Aspiration des cendres de cheminée  
Ashes aspiration

- ▶ **Système à décolmatage**  
Unclogging function
  - ▶ **Autoaspirant**  
Autosuction
  - ▶ **Cuve acier 15 L**  
15 L steel tank
  - ▶ **Poignée range câble pour faciliter le transport**  
Handle with cable storage for easier carrying
  - ▶ **Embout Alu**  
Aluminium nozzle
  - ▶ **Tube 1 mètre ø 35 mm acier**  
1 meter ø 35 mm metal tube
  - ▶ **Nombreux accessoires spécial poêle à granulés**  
Special accessories
- Livré avec filtre cartouche et 3 embouts  
Delivered with cartridge filter and 3 tips



Aspirateur vide cendres - Ashes vacuum cleaner		APG 15
Gencode		3431541010833
Puissance du moteur - Motor power (230V-50Hz)		1000 W 18 kpa
Volume de la cuve - Tank volume		15 L Acier - Steel
Longueur du tuyau - Hose length		ø 35 mm 1,0 m
Données logistiques - Logistic informations		
3 431541 010833		
Box 305x305x380 mm   Master 1 x 4,75 kg   Pal 30   Ctr 20ft 785 pcs		
Consommables - Consumables		
Filtre cartouche - Cartridge filter		343154101860

# Aspirateur eau et poussières - Vacuum cleaner - NETUP 20IC

20 L  
1400W



- ▶ **Vidange de cuve**  
Draining tank
- ▶ **Compact et léger** = pour atteindre les endroits difficiles d'accès  
Compact and lightweight = to reach difficult accesses
- ▶ **Cuve Inox 20 L eau et poussière**  
20 L inox tank water and dust
- ▶ **Tube télescopique + rallonge métal avec réglage du débit d'air**  
Metal telescopic tube + extension with air flow adjustment
- ▶ **Fonction souffleur** = pour repousser la poussière  
Blower function = to repel dust
- ▶ **2 roues arrières robustes + 2 roues multidirectionnelles** = grande maniabilité  
2 heavy-duty rear wheels + 2 multidirectional wheels = high handling

*Livré avec de nombreux accessoires*  
*Delivered with many accessories*



Vidange de cuve  
Draining tank



Fonction souffleur  
Air blowing function



x 4



**Blowing**  
Souffleur



**Air flow**  
Débit d'air



**Raccord**  
Tournant



**WET&DRY**

Aspirateur eau et poussières - Vacuum cleaner

NETUP 20IC

Gencode

**3431541010277**

Puissance du moteur - Motor power (230V-50Hz)

**1400 W**  
**18 kpa - 209 m³/h**

Volume de la cuve - Tank volume

**20 L**

**Inox**

Longueur du tuyau - Hose length

**ø 42 mm**  
**2,5 m**

Données logistiques - Logistic informations



3 431541 010277

Box 373x366x398 mm | Master 1 x 7,80 kg | Pal 18 | Ctr 20ft 532 pcs

Consommables - Consumables

Filtre cartouche - Cartridge filter

**3431541018099**

Sac à poussières - Dustbags

**3431541018334**

DÉCAPAGE  
STRIPPING

ÉLECTROPORTATIF  
HANDPOWER TOOLS

X-FIT  
RANGE

ATELIER  
WORKSHOP

BOIS  
WOOD MACHINES

MÉTAL  
METAL MACHINES

NETTOYAGE  
CLEANING

MÉTIERS  
MANUAL WORK

JARDIN FILAIRE  
GARDEN TOOLS

Plus d'infos sur  
**fartools.com**

# Aspirateur eau et poussières - Vacuum cleaner - NETUP 25IC

25 L  
1400W



Prise asservie  
Power socket



Vidange de cuve  
Draining tank



Fonction souffleur  
Air blowing function

- ▶ **Vidange de cuve**  
Draining tank
- ▶ **Prise asservie temporisée 3 s**  
Timer slave socket 3 s
- ▶ **Compact et léger = pour atteindre les endroits difficiles d'accès**  
Compact and lightweight = to reach difficult accesses
- ▶ **Cuve Inox 25 L eau et poussière**  
25 L inox tank water and dust
- ▶ **Tube télescopique + rallonge métal avec réglage du débit d'air**  
Metal telescopic tube + extension with air flow adjustment
- ▶ **Fonction souffleur = pour repousser la poussière**  
Blower function = to repel dust
- ▶ **2 roues arrière robustes + 2 roues multidirectionnelles = grande maniabilité**  
2 heavy-duty rear wheels + 2 multidirectional wheels = high handling

Livré avec de nombreux accessoires  
Delivered with many accessories



x 4



**Blowing**  
Souffleur



**Air flow**  
Débit d'air



**Raccord**  
Tournant



**Prise**  
Asservie



**WET&DRY**

Aspirateur eau et poussières - Vacuum cleaner

NETUP 25IC

Gencode **3431541010321**

Puissance du moteur - Motor power (230V-50Hz)

**1400 W**  
**18 kpa - 209 m³/h**

Volume de la cuve - Tank volume

**25 L**  
**Inox**

Longueur du tuyau - Hose length

**ø 42 mm**  
**2,5 m**

Données logistiques - Logistic informations



3 431541 010321

Box 373x366x468 mm | Master 1 x 9,05 kg | Pal 18 | Ctr 20ft 449 pcs

Consommables - Consumables

Filtre cartouche - Cartridge filter

**3431541018099**

Sac à poussières - Dustbags

**3431541018334**

# Aspirateur eau et poussières - Vacuum cleaner - NETUP 30PB

18 kpa  
1200W

**SPECIAL**  
plâtre et gravats  
plaster and rubbles



«Très bien pour l'aspiration de gravats ou de poussières.»  
Laurent L.



Décolmatage mécanique  
Mechanical cleaning



Décolmatage manuel par brosse  
Manual cleaning by brushing



Prise asservie  
Sunchronized socket

- ▶ **Décolmatage manuel par brosse**  
Manual cleaning by brushing
- ▶ **Prise asservie temporisée : démarrage 3s / Arrêt différé 8s**  
3s / 8s timer power socket: delayed start 3s / Delayed stop 8s
- ▶ **Vidange de cuve**  
Draining tank
- ▶ **Fonction souffleur**  
Blower function
- ▶ **Cuve inox 30 L eau et poussière**  
30 L inox tank water and dust
- ▶ **Tube télescopique + rallonge métal avec réglage du débit d'air**  
Metal telescopic tube + extension with air flow adjustment

Livré avec filtre cartouche, bonnette, sac à poussières, adaptateur, brosse étagère, brosse large, suceur et rallonge de tube.  
Delivered with cartridge filter, windscreen, dust bag, adaptor, shelf brush, broad brush, squeegee



x 4 **Blowing**  
Souffleur



**Air flow**  
Débit d'air



**Raccord**  
Tournant



**Prise**  
Asservie



**WET&DRY**



Aspirateur eau et poussières - Vacuum cleaner

NETUP 30PB

Gencode **3431541012110**

Puissance du moteur - Motor power (230V-50Hz)

1200 W  
18 kpa - 108m³/h

Volume de la cuve - Tank volume

30 L  
Inox

Longueur du tuyau - Hose length

ø 35 mm  
2,5 m

Données logistiques - Logistic informations



Box 360x360x595 mm | Master 1 x 7,30 kg | Pal 16 | Ctr 20ft 345 pcs

3 431541 012110

Consommables - Consumables

Filtre cartouche - Cartridge filter

3431541018297

Sac à poussières - Dustbags

3431541018341

DÉCAPAGE  
STRIPPING

ÉLECTROPORATIF  
HANDPOWER TOOLS

X-FIT  
RANGE

ATELIER  
WORKSHOP

BOIS  
WOOD MACHINES

MÉTAL  
METAL MACHINES

NETTOYAGE  
CLEANING

MÉTIERS  
MANUAL WORK

JARDIN FILAIRE  
GARDEN TOOLS

Plus d'infos sur  
**fartools.com**

# Aspirateur eau et poussières - Vacuum cleaner - MF 35PLASTER

20 kpa  
1600W

**SPECIAL**  
plâtre et gravats  
plaster and rubbles



«Sac tissu résistant et réutilisable.»  
Aurélien D.



Décolmatage  
Air pulse cleaning

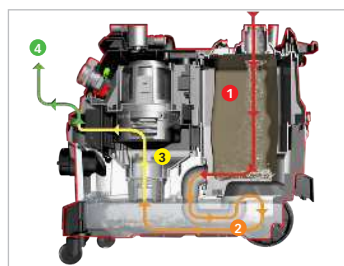

3 niveaux de filtration  
3 filtration levels



Fonction PLÂTRE  
PLASTER function

- ▶ **Système multi filtres en série pour toutes poussières et eaux**  
Multi filters system in series for all dust and water
  - ▶ **Double entrée d'aspiration**  
Double suction inlet
  - ▶ **Prise asservie temporisée : démarrage instantané / arrêt différé 10 s**  
Timed slave socket: instantaneous start / 10 s delayed stop
  - ▶ **Fonction décolmatage manuel**  
Manual unclogging function
  - ▶ **Fonction souffleur variable = pratique pour repousser la poussière**  
Variable blower function = ideal to repel dust
  - ▶ **Variateur du débit d'air pour l'aspirateur ou le souffleur**  
Air flow controller for the vacuum cleaner or blower
- Livré avec 2 filtres cartouche, 2 sacs en tissu, tube inox, 2 suceurs larges, 1 brosse ronde, 1 adaptateur, 1 suceur long.*  
Supplied with 2 cartridge filters, 2 fabric bags, stainless steel tube, 2 wide nozzles, 1 round brush, 1 adapter, 1 long nozzle.



x 4 **Blowing**  
Souffleur



**Air flow**  
Débit d'air



**SPEED**  
Control



**Prise**  
Asservie



**WET&DRY**



Aspirateur eau et poussières - Vacuum cleaner	<b>MF 35PLASTER</b>
Gencode	<b>3431541012134</b>
Puissance du moteur - Motor power (230V-50Hz)	<b>1600 W</b> <b>20 kpa</b>
Volume de la cuve - Tank volume	<b>35 L</b> <b>PVC</b>
Longueur du tuyau - Hose length	<b>ø 32 mm</b> <b>2 m</b>

Données logistiques - Logistic informations

Box 610x375x575 mm | Master 1 x 16,45 kg | Pal 10 | Ctr 20ft 216 pcs

Consommables - Consumables

3 431541012134	Barcode
3431541018563	Filter cartouche mousse - Foam cartridge filter
3431541018570	Filter cartouche - Cartridge filter
3431541018587	Sac toile pour cuve - Fabric bag for tank
3431541018594	Sac a poussières extérieur - Exterior bag for tank

# Aspirateur à décolmatage - Vacuum cleaner - NETUP 30AUTO

20 kpa  
1600W

**SPECIAL**  
chantier & plâtre  
Construction & plaster

**NOUVEAU**

**DÉCOLMATAGE AUTOMATIQUE**

Toutes les 20 secondes

Automatic unclogging every 20 seconds

**AUTOMATIC**



► **Décolmatage automatique toutes les 20 secondes**  
Automatic pulse cleaning every 20s

► **Prise asservie temporisée (2000W maxi) :**  
démarrage instantané / arrêt différé 3 s

Timed slave socket (2000W max): instantaneous start / 3 s delayed stop

► **Flexible 4 m antistatique**  
4 M anti-static hose

► **Moteur endurant = Idéal travaux de chantier**  
Enduring engine = Usefull on construction site

► **Fonction eaux et poussières**  
Wet & dry function

► **Tube télescopique métal**  
Metal telescopic tube

Livré avec un flexible 2,5 m, un tube télescopique, un filtre cartouche, un sac à poussières, un adaptateur, une brosse large, un suceur

Delivered with a 2.5 m hose, a telescopic tube, a cartridge filter, a dust bag, an adapter, a wide brush, a nozzle



Décolmatage **AUTOMATIQUE**  
Auto pulse cleaning



Sécurité anti-débordement  
Overflow security



x 4



Prise  
Asservie



WET&DRY



Fonction PLÂTRE  
PLASTER function

Aspirateur eau et poussières - Vacuum cleaner		NETUP 30AUTO
Gencode		<b>3431541012318</b>
Puissance du moteur - Motor power (230V-50Hz)		<b>1600 W</b> <b>20 kpa</b>
Volume de la cuve - Tank volume		<b>30 L</b> <b>PVC</b>
Longueur du tuyau - Hose length		<b>ø 32 mm</b> <b>4 m</b>
Données logistiques - Logistic informations		
Box N.C. mm   Master 1 x N.C.   Pal N.C.   Ctr 20ft N.C.		
Consommables - Consumables		
Filtre cartouche - Cartridge filter		<b>3431541018648</b>
Sac toile pour cuve - Fabric bag for tank		<b>3431541018655</b>

DÉCAPAGE  
STRIPPING

ÉLECTROPORTATIF  
HANDPOWER TOOLS

X-FIT  
RANGE

ATELIER  
WORKSHOP

BOIS  
WOOD MACHINES

MÉTAL  
METAL MACHINES

NETTOYAGE  
CLEANING

MÉTIERS  
MANUAL WORK

JARDIN FLAIRE  
GARDEN TOOLS

Plus d'info sur  
**fartools.com**

70 L  
3000W



- ▶ **Vidange de cuve**  
Draining tank
- ▶ **Cuve basculante = vidange facile des poussières**  
Tilting tank = easy to drain dust
- ▶ **Cuve Inox 70 L eau et poussière**  
70 L inox tank water and dust
- ▶ **3 moteurs indépendants de 1000 W**  
3 puissances possibles : 1000 / 2000 / 3000 W  
3 independent motors of 1000 W  
3 possible potencies: 1000/2000/3000 W
- ▶ **Suceur large à l'avant : travail des très grandes surfaces**  
Wide front nozzle: work for big area

*Livré avec 1 suceur large pour grandes surfaces*  
*Delivered with 1 wide nozzle for large surfaces*

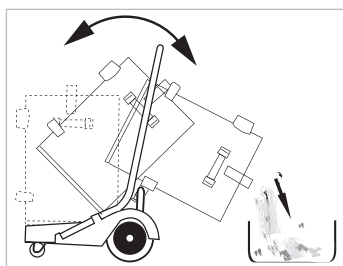

Vidange de cuve  
Draining tank



x 4



**Raccord**  
Tournant



**WET&DRY**



Suceur large : grandes surfaces  
Wide nozzle : big surfaces

Aspirateur eau et poussières - Vacuum cleaner		PRO NET70B
Gencode	3431541012561	
Puissance du moteur - Motor power (230V-50Hz)	3x 1000 W 18 kpa - 180 m³/h	
Volume de la cuve - Tank volume	70 L Inox	
Longueur du tuyau - Hose length	ø 38 mm 3,0 m	
Données logistiques - Logistic informations		
Box 630x520x840 mm   Master 1 x 30,00 kg   Pal 8   Ctr 20ft 108 pcs		
 3 431541 012561		
Consommables - Consumables		
Filtere cartouche - Cartridge filter	3431541018624	
Filtere toile pour cuve - Fabric filter for tank	3431541018617	

L'univers de la

Metrology range

# Métrie

OUTILS DE MESURE : DISTANCE - NIVEAU - TEMPÉRATURE - HUMIDITÉ...



DÉCAPAGE  
STRIPPING

ÉLECTROPORATIF  
HANDPOWER TOOLS

X-FIT  
RANGE

ATELIER  
WORKSHOP

BOIS  
WOOD MACHINES

MÉTAL  
METAL MACHINES

NETTOYAGE  
CLEANING

MÉTRÉLOGIE  
METROLOGY

JARDIN FILAIRE  
GARDEN TOOLS

Plus d'info sur  
[fartools.com](http://fartools.com)



## Niveau laser en croix - laser level - NL 12

12 m



«La tolérance est très correcte pour tous les travaux.»

Wilfried Z.



- ▶ **Autostabilisation du niveau à +/- 3,5 °**  
Self adjustable level, since 3,5 °
- ▶ **Portée : 12 mètres**  
Range: 12 meters
- ▶ **Arêtes protégées par revêtement caoutchouc**  
Edges protected by rubber coating
- ▶ **Filetage standard trépied (compatible accessoires photo), pour grande stabilité**  
Thread for arrangement on a tripod, for better stability
- ▶ **Type de rayon : en croix**  
Type of spoke: cross
- ▶ **Couleur de rayons : rouge**  
Rays color: red
- ▶ **Arrêt automatique**  
Auto power off



Livré avec pochette de protection  
Delivered with protection Pouch

Niveau laser en croix - Laser level	NL 12
Gencode	3431541325050
Tension/puissance de la batterie - Battery voltage and power	2 x 1,5 V AA LR 06 (non fournies)
Visée laser - Laser target	Classe 2 / 1mW max
Portée de la mesure - Measure range	12 m
Données logistiques - Logistic informations	



3 431541 1325050

Box 130x70x110 mm | Master 10 x 0,3 kg | Pal 650 pcs | Ctr 20ft 4300 pcs

## Niveau laser 360° - 360° laser level - NL 20

20 m

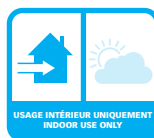

- ▶ **Ligne horizontale à 360 °**  
360 ° Horizontal line
- ▶ **Autostabilisation du niveau à +/- 3 mm**  
Self adjustable level, since 3 mm
- ▶ **Portée : 20 mètres**  
Range: 20 meters
- ▶ **Arêtes protégées par revêtement plastique**  
Edges protected by plastic coating
- ▶ **Filetages standards trépied (compatible accessoires photo), pour grande stabilité**  
Threads for arrangements on a tripod, for better stability
- ▶ **Type de rayon : Horizontal, vertical ou en croix**  
Type of spoke: Horizontal, vertical or cross
- ▶ **Couleur de rayons : rouge**  
Rays color: red
- ▶ **Arrêt automatique**  
Auto power off

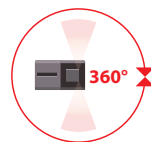

Livré avec pochette de protection  
Delivered with protection Pouch

Niveau laser 360° en croix - 360° Laser level	NL 20
Gencode	3431541325098
Tension/puissance de la batterie Battery voltage and power	4 x 1,5 V AA LR 06 (non fournies)
Visée laser - Laser target	Classe 2 / 1mW max
Portée de la mesure - Measure range	20 m
Données logistiques - Logistic informations	



3 431541 1325098

Box 140x82x140 mm | Master 10 x 0,525 kg | Pal 1500 pcs | Ctr 20ft 15000 pcs

# Télémètre laser - Rangefinder - TL 30

30 m



«Bonne précision à l'intérieur comme à l'extérieur. Calculs complets.»  
Pierre J.

**3 en 1**

Distances  
Surfaces  
Volumes

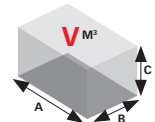
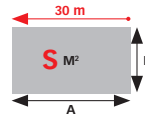

- ▶ **3 types de mesure : distance, surface et volume**  
3 types of measurement : distance, surface & volume
- ▶ **Arêtes protégées par revêtement caoutchouc**  
Edges protected by rubber coating
- ▶ **Filetage standard pour disposition sur un trépied (compatible accessoires photo), pour une meilleure stabilité**  
Thread for arrangement on a tripod, for better stability
- ▶ **Mesure simple, en continu ou par addition**  
Simple measurement, continuously or by addition

Livré avec dragonne  
Supplied with wrist strap



Télémètre laser - Rangefinder	<b>TL 30</b>
Gencode	<b>3431541325067</b>
Tension/puissance de la batterie - Battery voltage and power	2 x 1,5 V AAA (non fournies)
Visée laser - Laser target	Classe 2 / 1mW max
Portée de la mesure - Measurement range	30 m

Données logistiques - Logistic informations



3 431541 325067

# Détecteur d'humidité DIGITAL - DIGITAL moisture detector - 2 IN 1



«La détection est fiable sur différents matériaux.»  
Méline L.



- ▶ **Détection d'humidité par induction et par aiguilles dans différents matériaux, de 6 à 70 % (± 10 %)**  
Induction and needle humidity detection in different materials from 6 to 70 % (± 10 %)
- ▶ **Température ambiante**  
Ambient temperature
- ▶ **A travers : plaque de plâtre, béton, bois tendre, bois sec.**  
Across: plasterboard, concrete, softwood, dry wood.
- ▶ **Détection de la température ambiante, en ° Celsius et ° Fahrenheit**  
Temperature detection, in ° Celsius and ° Fahrenheit
- ▶ **Capot de protection pour aiguilles**  
Protective carter for needles

Livré avec pochette de protection  
Delivered with protection Pouch



Détecteur d'humidité DIGITAL - DIGITAL moisture detector	<b>2 IN 1</b>
Gencode	<b>3431541325074</b>
Tension/puissance de la batterie - Battery voltage and power	2 x 1,5 V AAA (non fournies)
Capacité de détection - Detection capacity	6 - 70 %

Données logistiques - Logistic informations



3 431541 325074

Box 110x70x237 mm | Master 20 x 0,2 kg | Pal 560 pcs | Ctr 20ft 77630 pcs

DÉCAPAGE  
STRIPPING  
ÉLECTROPORTATIF  
HANDPOWER TOOLS  
X-FIT  
RANGE  
ATELIER  
WORKSHOP  
BOIS  
WOOD MACHINES  
MÉTAL  
METAL MACHINES  
NETTOYAGE  
CLEANING  
MÉTROLOGIE  
METROLOGY  
JARDIN FILAIRE  
GARDEN TOOLS

Plus d'info sur  
**far.tools.com**

-40° à +530°



- ▶ **Ecran LCD rétro-éclairé**  
Backlit LCD display
- ▶ **Arrêt automatique**  
Auto power off
- ▶ **Mesure de - 40° C à 530° C, en Celsius ou en Fahrenheit**  
Measurement from - 40° C to 530° C, in Celsius or Fahrenheit
- ▶ **Mesure la température à distance (Ratio 12:1)**  
Remotely measure temperature (Ratio 12: 1)



Thermomètre infrarouge DIGITAL DIGITAL infrared thermometer	IRT 530
Gencode	<b>3431541325081</b>
Tension/puissance de la batterie - Battery voltage and power	2 x 1,5 V AAA (non fournies)
Visée laser - Laser target	Classe 2 / 1mW max
Portée de la mesure - Measure range	3,6 m
Données logistiques - Logistic informations	



3 431541 325081

Box 165x50x280 mm | Master 30 x0,15 kg | Pal 600 pcs | Ctr 20ft 20000 pcs

L'univers de la

Building range

# Construction

PERVIBRATION - RAINURAGE - PERÇAGE - DÉMOLITION

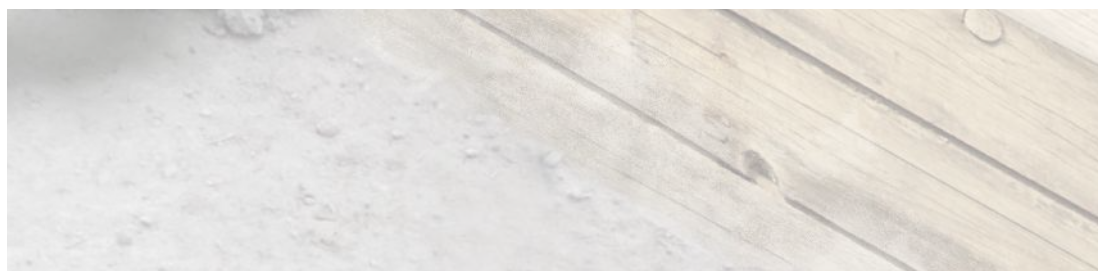

DÉCAPAGE  
STRIPPING

ÉLECTROPORTATIF  
HANDPOWER TOOLS

X-FIT  
RANGE

ATELIER  
WORKSHOP

BOIS  
WOOD MACHINES

MÉTAL  
METAL MACHINES

NETTOYAGE  
CLEANING

CONSTRUCTION  
BUILDING

JARDIN FILAIRE  
GARDEN TOOLS

Plus d'info sur  
[fartools.com](http://fartools.com)

# Offre complète de 1 à 2 mètres linéaires

Complete offer from 1 to 2 meters linear



# Marteau perforateur SDS - SDS rotary hammer - HY 1500D

6,0 J  
1600 Watts



## PRODUIT MALIN SMART PRODUCT

ADAPTATEUR POUR ASPIRATEUR  
ADAPTER FOR VACUUM CLEANER

ø 70 mm maxi



34315411592:5

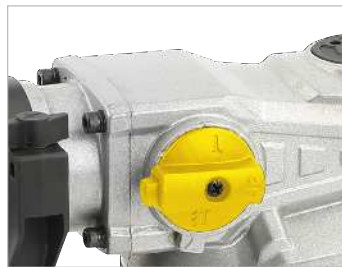

x 4 fonctions  
x 4 fonctions



Poignée anti-vibration  
Anti vibrations system

- ▶ Grande puissance : 6,0 J  
High power: 6,0 J
- ▶ Système anti-vibrations  
Anti vibrations system
- ▶ Poignée avant amovible et orientable à 360 °  
Removable and 360 ° swivel front handle
- ▶ 4 fonctions : Perçage + Percussion / Percussion + burinage  
Burinage / Ajustement angle burin  
4 functions: Drilling + Percussion / Percussion + Chiseling  
Chiseling / Chisel angle adjustment
- ▶ Tête en métal  
Metal head
- ▶ Mandrin SDS  
SDS chuck



Livré en mallette avec accessoires : 3 forets SDS + 2 burins (plat et pointu)  
Delivered with accessories: 3 SDS drills + 2 chisels (flat and pointed)



SDS



MULTI  
Multi



PERCU.  
Impact



Grip  
RUBBER  
Grip

Marteau perforateur SDS - SDS Rotary hammer

HY 1500D

Gencode

3431541154759

Puissance du moteur - Motor power (230V-50Hz)

1600 W | 6,0 J

Vitesse de rotation - Rotation speed

800 min<sup>-1</sup>

Fonction percussion - Impact function

4000 hit.min<sup>-1</sup>

Multifonctions - Multifunctions

x 4

Niveau de bruit - Noise level (dB)

96-107 (+/-3,0)

Données logistiques - Logistic informations



3 431541154759

Box 430x130x340 mm | Master 2 x 8,0 kg | Pal 48 | Ctr 20ft 1350 pcs

Consommables - Consumables

Mandrin à clef 13 mm - Key chuck

3431541158009

DÉCAPAGE  
STRIPPING

ÉLECTROPORATIF  
HANDPOWER TOOLS

X-FIT  
RANGE

ATELIER  
WORKSHOP

BOIS  
WOOD MACHINES

MÉTAL  
METAL MACHINES

NETTOYAGE  
CLEANING

CONSTRUCTION  
BUILDING

JARDIN FILAIRE  
GARDEN TOOLS

Plus d'info sur  
fartools.com

# Marteau perforateur SDS MAX - SDS MAX rotary hammer - RH10 MAX

10,0 J  
1600 Watts



«Que du positif !  
Poids contenu, peu de vibrations  
et hyper efficace.»  
Laurent L.



**PRODUIT MALIN**  
SMART PRODUCT

ADAPTATEUR POUR ASPIRATEUR  
ADAPTER FOR VACUUM CLEANER

ø 70 mm maxi

+

343154115923 5



x 3 fonctions  
x 3 fonctions



Poignée anti-vibration  
Anti vibrations system

- ▶ Grande puissance : 10,0 J  
High power: 10,0 J
- ▶ Mandrin SDS MAX  
SDS MAX chuck
- ▶ Système anti-vibration  
Anti vibration system
- ▶ Poignée avant orientable à 360°  
360° Swivel front handle
- ▶ 3 fonctions :  
Percussion + burinage / Burinage / Ajustement angle burin  
3 functions:  
ImpactDrill + Chipping / Fixed impact / Chisel angle adjustment
- ▶ Tête en métal  
Metal head



Livré en mallette avec accessoires : 1 foret SDS Max + 1 burin (pointu)  
Delivered with accessories: 1 SDS Max drill bit + 1 chisel (pointed)



SDS  
MAX



MULTI  
Multi



PERCU.  
Impact



RUBBER  
Grip

Marteau perforateur SDS MAX - SDS MAX Rotary hammer	RH10 MAX
Gencode	3431541153905
Puissance du moteur - Motor power (230V-50Hz)	1600 W   10,0 J
Vitesse de rotation - Rotation speed	630 min <sup>-1</sup>
Fonction percussion - Impact function	3800 hit.min <sup>-1</sup>
Multifonctions - Multifunctions	x 3
Niveau de bruit - Noise level (dB)	88 - 99 (+/-3,0)
Données logistiques - Logistic informations	
Box 450x384x132 mm   Master 2 x 7,30 kg   Pal 48   Ctr 20ft 400 pcs	
Consommables - Consumables	
Spatule métal pour SDS max (18 x 400 x 150 mm) - SDS MAX Spatula	3431541157829



3 431541 1153905

# Piqueur burineur SDS MAX - SDS MAX Chisel hammer - RH20 MAX

20,0 J  
1300 Watts



- ▶ Grande puissance : 20,0 J  
High power: 20,0 J
- ▶ Mandrin SDS MAX  
SDS MAX chuck
- ▶ Système anti-vibration  
Anti vibration system
- ▶ Poignée de force pour prise en main de la machine,  
orientable à 360°  
Power handle for grip the machine,  
360° Swivel front handle
- ▶ Tête en métal  
Metal head



Livré en mallette avec accessoires : 2 burins (pointu + plat), clef de serrage et flacon d'huile  
Delivered with accessories: 2 chisels (pointed + flat), key and oil bottle



Poignée anti-vibration  
Anti vibrations system

Piqueur burineur SDS MAX - SDSMAX Chisel hammer	RH20 MAX
Gencode	3431541153851
Puissance du moteur - Motor power (230V-50Hz)	1300 W   20,0 J
Fonction percussion - Impact function	3800 hit.min <sup>-1</sup>
Données logistiques - Logistic informations	
	
Box 510x290x390 mm   Master 2 x 19 kg   Pal 48   Ctr 20ft 970 pcs	
Consommables - Consumables	
Spatule métal pour SDS max (18 x 400 x 150 mm) - SDS MAX Spatula	3431541157829

DÉCAPAGE  
STRIPPING

ÉLECTROPORTATIF  
HANDPOWER TOOLS

X-FIT  
RANGE

ATELIER  
WORKSHOP

BOIS  
WOOD MACHINES

MÉTAL  
METAL MACHINES

NETTOYAGE  
CLEANING

CONSTRUCTION  
BUILDING

JARDIN FILAIRE  
GARDEN TOOLS

Plus d'info sur  
[fartools.com](http://fartools.com)



# Brise béton - Demolition hammer - DBH 1700D

60 Joules  
1700 Watts



«Puissant, bonne prise en main et relativement silencieux.»  
Aurélien D.



SUPPORT BRISE BÉTON  
MÉTAL AVEC ILLV CARTON  
DEMOLITION HAMMER  
METAL DISPLAY WITH ILLV

3431541400566

Optimisez vos mètres linéaires  
Optimize your displays

- ▶ Grande puissance : 60,0 J  
High power: 60,0 J
- ▶ Mandrin HEX 30  
HEX 30 chuck
- ▶ Poignée principale avec double zone d'absorption des vibrations  
Back handle with twice antivibration system
- ▶ Poignée auxiliaire orientable 360°  
360° rotation front handle
- ▶ Interrupteur gachette  
Trigger switch
- ▶ Protection réservoir de graisse métallique  
Metallic grease tank protection

Livré en mallette plastique avec roues de transport,  
2 burins (pointu et plat) et flacon d'huile  
Delivered in plastic case with 2 chisels (pointed + flat) and oil bottle

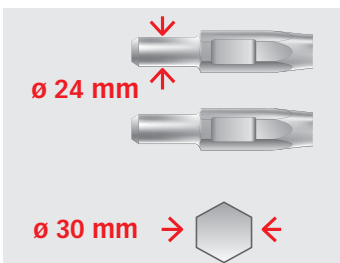

Brise béton - Demolition hammer		DBH 1700D
Gencode		3431541153691
Puissance du moteur - Motor power (230V-50Hz)		1700 W - 60 Joules
Fonction percussion - Impact function		1900 hit.min <sup>-1</sup>
Nombre de fonctions - number of functions		1
Type d'embout - Tip		Hexagonal
Données logistiques - Logistic informations		
Box 880x355x190 mm   Master 1 x 23,45 kg   Pal 18 pcs   Ctr 20ft 580 pcs		
Consommables - Consumables		
Burin plat - Flat chisel 33x400 mm		3431541158122
Pointe diamant - Diamond chisel 30x410 mm		3431541158139

## Burin bêche - Metal peg plier

140 mm

- ▶ Emmanchement hexagonal  
Hexagonal bit



Gencode **3431541157804**

Données logistiques - Logistic informations



Box 30x550x110 mm | Master 1x3,55 kg  
Pal 3500 | Ctr 20ft 25000 pcs

## Plateau de compactage - Compaction plate

200 x 260 mm

- ▶ Emmanchement hexagonal  
Hexagonal bit

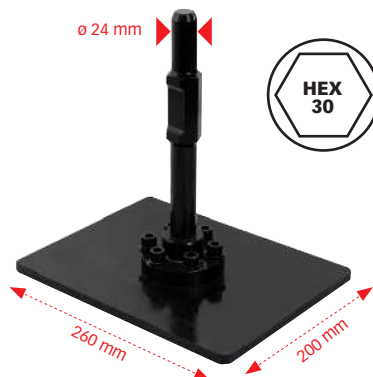

Gencode **3431541157811**

Données logistiques - Logistic informations



Box 300x220x30 mm | Master 1x6,25 kg  
Pal 2000 | Ctr 20ft 25000 pcs

## Spatule métal - Metal spatula

SDS MAX - 150 mm

- ▶ Embout SDS MAX  
SDS MAX bit
- ▶ Idéal pour décoller carrelage, faïence et colle  
Ideal for removing tiles, earthenware and glue

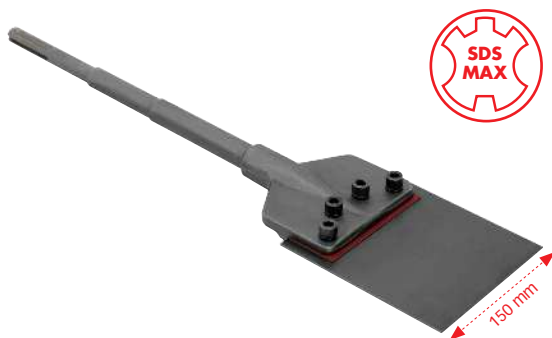

Gencode **3431541157828**

Données logistiques - Logistic informations



Box 18x400x150 mm | Master 10x3,28 kg  
Pal 2500 | Ctr 20ft 25000 pcs

## Spatule métal - Metal spatula

SDS PLUS - 75 mm

- ▶ Embout SDS Plus  
SDS plus bit
- ▶ Idéal pour décoller carrelage, faïence et colle  
Ideal for removing tiles, earthenware and glue

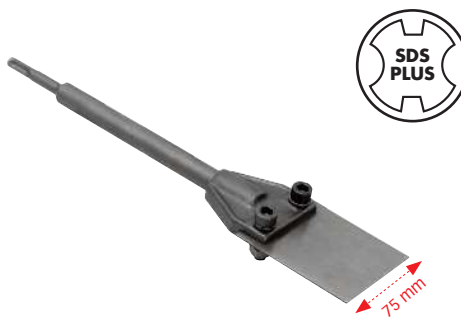

Gencode **3431541157835**

Données logistiques - Logistic informations



Box 14x230x75 mm | Master 10x0,99 kg  
Pal 2900 | Ctr 20ft 25000 pcs

DÉCAPAGE  
STRIPPING

ÉLECTROPORATIF  
HANDPOWER TOOLS

X-FIT  
RANGE

ATELIER  
WORKSHOP

BOIS  
WOOD MACHINES

MÉTAL  
METAL MACHINES

NETTOYAGE  
CLEANING

CONSTRUCTION  
BUILDING

JARDIN FILAIRE  
GARDEN TOOLS

Plus d'info sur  
**far.tools.com**

# Carotteuse - Core drill - CB 1700

ø 83 mm  
1600 Watts



## PRODUIT MALIN SMART PRODUCT

TREPANS DIAMANTÉS  
DIFFÉRENTS DIAMETRES  
DIAMOND DRILL BITS, SEVERAL  
DIAMETERS



BRIQUE  
BRICK

PIERRE  
STONE

BÉTON  
CONCRETE



Tous matériaux  
All materials



Forage a sec ou à eau  
Wet or dry drilling



Idéal pour le perçage des éclairages  
Ideal for drilling lights

- ▶ **Prise de protection contre les surtensions (PRCD)**  
Surge protection socket
- ▶ **Protection thermique manuelle**  
Manual auto relay
- ▶ **Poignée 3 positions**  
Handle 3 positions
- ▶ **Robinet d'alimentation en eau + tuyau raccord source d'eau**  
Water supply tap + water source connection hose
- ▶ **Crosse ergonomique d'appui**  
Ergonomic stock
- ▶ **Diamètre de perçage maximum : 130 mm**  
Maximum drilling diameter: 130 mm
- ▶ **Thermique de sécurité**  
Thermal protection

*Livré avec trépan diamanté ø 83 mm, charbons, clef de serrage et tuyau eau*  
*Delivered with diamond drill bit ø 83 mm, carbon brushes, key and water pipe*

Carotteuse - Core drill		CB 1700
	Gencode	<b>3431541150867</b>
Puissance du moteur - Motor power (230V-50Hz)		<b>1700 W</b>
Vitesse - Speed		<b>0-1990 tr.min<sup>-1</sup></b>
Dimensions outil - tool sizes		<b>ø 83 x 400 mm</b>
Dimensions outil maximum - tool maximal size		<b>ø 130 mm Maxi</b>
Diamètre de l'arbre - Arbor diameter		<b>1" 1/4-7</b>
<b>Données logistiques - Logistic informations</b>		
		Box 1420x130x180 mm   Master 1 x 5,6kg   Pal 18 pcs   Ctr 20ft 330 pcs
<b>Consommables - Consumables</b>		
Trépan diamanté ø 83 - l 400 mm - Diamond drill bit ø 83 - l 400 mm		<b>3431541150959</b>
Trépan diamanté ø 102 - l 400 mm - Diamond drill bit ø 102 - l 400 mm		<b>3431541150966</b>
Trépan diamanté ø 132 - l 400 mm - Diamond drill bit ø 132 - l 400 mm		<b>3431541150973</b>

# Carotteuse sur support - Core drill with support - CB 2300S

Maxi ø 180 mm  
2300 Watts

**NOUVEAU**

**PRODUIT MALIN**  
SMART PRODUCT

TRÉPANS DIAMANTÉS  
DIFFÉRENTS DIAMÈTRES  
DIAMOND DRILL BITS, SEVERAL  
DIAMETERS



Tous matériaux  
All materials



Confort d'utilisation en perçage horizontal  
Ease of use in horizontal drilling



- ▶ **Prise de protection contre les surtensions (PRCD)**  
Surge protection socket
- ▶ **Protection thermique manuelle**  
Manual auto relay
- ▶ **Robinet d'alimentation en eau + tuyau raccord source d'eau**  
Water supply tap + water source connection hose
- ▶ **Diamètre de perçage maximum : 180 mm**  
Maximum drilling diameter: 180

*Livrée sans trépan diamanté, avec charbons, clef de serrage et tuyau eau*  
*Delivered without diamond drill bit, with carbon brushes, key and water pipe*

Carotteuse sur support - Core drill with support

CB 2300S

Gencode	<b>3431541150898</b>
Puissance du moteur - Motor power (230V-50Hz)	<b>2300 W</b>
Vitesse - Speed	<b>0-1400 tr.min<sup>-1</sup></b>
Dimensions outil maximum - tool maximal size	<b>ø 180 mm Maxi</b>
Diamètre de l'arbre - Arbor diameter	<b>1" 1/4-7</b>

Données logistiques - Logistic informations



3 431541 150898

Box N.C. | Master N.C.g | Pal N.C. | Ctr 20ft N.C.

Consommables - Consumables

Trépan diamanté ø 83 - l 400 mm - Diamond drill bit ø 83 - l 400 mm	<b>3431541150959</b>
Trépan diamanté ø 102 - l 400 mm - Diamond drill bit ø 102 - l 400 mm	<b>3431541150966</b>
Trépan diamanté ø 132 - l 400 mm - Diamond drill bit ø 132 - l 400 mm	<b>3431541150973</b>

DÉCAPAGE  
STRIPPING

ÉLECTROPORATIF  
HANDPOWER TOOLS

X-FIT  
RANGE

ATELIER  
WORKSHOP

BOIS  
WOOD MACHINES

MÉTAL  
METAL MACHINES

NETTOYAGE  
CLEANING

CONSTRUCTION  
BUILDING

JARDIN FILAIRE  
GARDEN TOOLS

Plus d'info sur  
**far.tools.com**

# Rainureuse - Slot cutter - SC 150F

ø 150 mm  
1700 Watts

**NOUVEAU**



Indicateur de mise sous tension  
Power indicator



Disque de haute qualité  
High quality disc

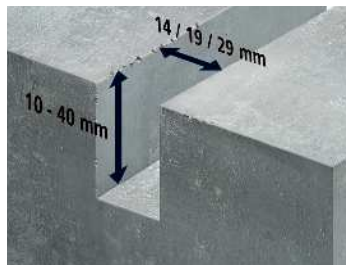

- ▶ **Thermique de sécurité automatique**  
Automatic thermal protection
- ▶ Démarrage progressif  
Soft start
- ▶ Disque de haute qualité  
High quality cutting disc
- ▶ Réglage rapide de la profondeur de coupe  
Cutting depth fast adjustment
- ▶ Réglage largeur de rainure par jeu d'entretoises  
Groove width adjustment by set of spacers
- ▶ Collecteur de poussières  
Dust collector
- ▶ Protection thermique en cas de surchauffe  
Thermal protection

Livré avec 2 disques diamant HQ ø 150 mm  
Delivered with 2 discs ø 150 mm



**DUST**  
Collector

Rainureuse - Slot cutter

SC 150F

Gencode **3431541154414**

Puissance du moteur - Motor power (230V~50Hz)

**1700 W**

Diamètre / alésage de la lame - Blade diameter / bore

**ø 150 / 22,2 mm**

Largeur de la rainure - Cutting width

**14 / 19 / 29 mm**

Vitesse de rotation - Rotation speed

**4500 tr.min<sup>-1</sup>**

Profondeur de coupe - Depth cutting

**10-40 mm**

Données logistiques - Logistic informations



Box 355x215x360 mm | Master 2 X 7,4 kg | Pal 36 pcs | Ctr 20ft 910 pcs

Consommables - Consumables

Disque - Disc

**3431541190214**

# Découpeuse à matériaux - Materials cutter - MC 355A

2600 W  
 ø 355 mm

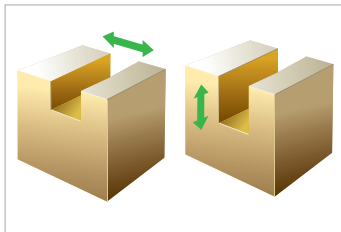

Coupe : l 3,2x h 120 mm  
 Cutting: l 3,2x h 120 mm



Tous types de matériaux  
 All types of materials

- ▶ Profondeur ajustable, jusqu'à 120 mm  
 Adjustable depth, up to 120 mm
- ▶ Démarrage progressif  
 Soft start
- ▶ Système hydraulique  
 Hydraulic system
- ▶ PRCD : Disjoncteur différentiel de protection des personnes  
 Protective differential circuit breaker
- ▶ Carter indexable sans outil  
 Carter to be swivelled without tool
- ▶ Roues de déplacement  
 Travel wheels

Livrée avec disque, système hydraulique, système de protection PRCD, roues et clé allen.  
 Delivered with disc, hydraulic system, PRCD protection system, wheels and allen key.



Découpeuse à matériaux - Materials cutter	MC 355A
Gencode	3431541150874
Puissance du moteur - Motor power (230V-50Hz)	2600 W
Vitesse de rotation - Rotation speed	4300 tr.min <sup>-1</sup>
Capacité de coupe - Cutting capacity	120 mm
Filetage - Thread	M 10

Données logistiques - Logistic informations



Box 310x295x230 mm | Master 1 x 6,5 kg | Pal 36 pcs | Ctr 20ft 780 pcs

Consommables - Consumables

Disque Ø 355 mm - Disc Ø 355 mm

3431541150881

DÉCAPAGE  
STRIPPING

ÉLECTROPORATIF  
HANDPOWER TOOLS

X-FIT  
RANGE

ATELIER  
WORKSHOP

BOIS  
WOOD MACHINES

MÉTAL  
METAL MACHINES

NETTOYAGE  
CLEANING

CONSTRUCTION  
BUILDING

JARDIN FILAIRE  
GARDEN TOOLS

Plus d'info sur  
**fartools.com**

## Plateau de ponçage béton pour meuleuse d'angle

Concrete sanding pad

Ø 180 mm



- Compatible sur toutes les meuleuses d'angle 180/230 mm grâce au jeu de 6 bagues d'adaptation  
Compatible with all angle grinders 180/230 mm thanks to the set of 6 adapter rings
- Trappe escamotable pour travail des angles et bordures  
Retractable hatch for working on corners and edges
- Collecteur de poussières  
Dust collector

Plateau de ponçage béton Concrete sanding pad	
Gencode	3431541159242
Compatibilité - Compatibility	Meuleuse Ø 230 mm
Aspiration des poussières - Dust extraction	ok
Carter escamotable - Retractable housing	ok
Données logistiques - Logistic informations	
Box 230x230x95 mm   Master 12x1,6 kg Pal 180   Ctr 20ft 25000 pcs	

## Plateau de ponçage béton pour meuleuse d'angle

Concrete sanding pad

Ø 125 mm



- Compatible sur toutes les meuleuses d'angle 115/125 mm grâce au jeu de 4 bagues d'adaptation  
Compatible with all angle grinders 115/125 mm thanks to the set of 4 adapter rings
- Trappe escamotable pour travail des angles et bordures  
Retractable hatch for working on corners and edges
- Collecteur de poussières  
Dust collector

Plateau de ponçage béton Concrete sanding pad	
Gencode	3431541159266
Compatibilité - Compatibility	Meuleuse Ø 125 mm
Aspiration des poussières - Dust extraction	ok
Carter escamotable - Retractable housing	ok
Données logistiques - Logistic informations	
Box 190x94x170 mm   Master 20x0,6 kg Pal 360   Ctr 20ft 30000 pcs	

## Carter de rainureuse pour meuleuse d'angle

Concrete grooving housing

Ø 125 mm



- Compatible sur toutes les meuleuses d'angle 115/125 mm grâce au jeu de 4 bagues d'adaptation  
Compatible with all angle grinders 115/125 mm thanks to the set of 4 adapter rings
- Capot avant escamotable pour raccord de rainurage sol/mur parfaitement aligné  
Retractable front cover for perfectly aligned floor/wall grooving connection
- Collecteur de poussières  
Dust collector

Carter de rainureuse Concrete grooving housing	
Gencode	3431541159259
Compatibilité meuleuses Angle grinder Compatibility	Ø 115 - 125 mm A variateur de vitesses
Aspiration des poussières - Dust extraction	ok
Données logistiques - Logistic informations	
Box 260x200x100 mm   Master 12x1,48 kg Pal 168   Ctr 20ft 25000 pcs	

# Meuleuse d'angle - Angle grinder - KL 230E

ø 230 mm  
2350 Watts

**PRODUIT MALIN**  
SMART PRODUCT

ÉCROU DE SERRAGE UNIVERSEL  
UNIVERSAL CLAMP NUT



3431541101203



3 431541 101203



Poignée orientable à +/- 90°  
Adjustable handle +/- 90°

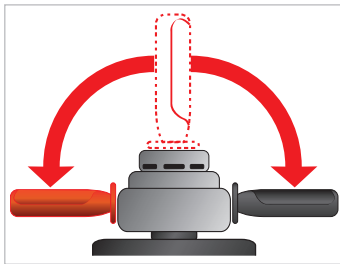

Poignée 3 positions  
3 positions handle



Carter indexable avec clé (fournie)  
Swivelled carter with key (provided)

- ▶ Poignée arrière orientable +/- 90°  
Adjustable handle +/- 90°
- ▶ Démarrage progressif  
Soft start
- ▶ Blocage d'arbre  
Arbor lock
- ▶ Poignée 3 positions / Poignée arrière rotative anti-vibration  
Handle 3 positions / Anti-vibration rotating rear handle
- ▶ Carter indexable  
Case to be swivelled

Livrée avec poignée et clé de serrage  
Delivered with handle and tightening key



**Arbor Lock**



**Soft Start**



**RUBBER Grip**

Meuleuse d'angle - Angle grinder	KL 230E
Gencode	<b>3431541150775</b>
Puissance du moteur - Motor power (230V-50Hz)	<b>2350 W</b>
Vitesse de rotation - Rotation speed	<b>5800 tr.min<sup>-1</sup></b>
Diamètre / alésage de la lame - Blade diameter / bore	<b>ø 230 / 22,2 mm</b>
Diamètre de l'arbre - Arbor diameter	<b>M14</b>
Nombre de position de poignée - Handle positions number	<b>x 3</b>
Blocage d'arbre - Arbor lock	<b>OK</b>

Données logistiques - Logistic informations



Box 510x280x190 mm | Master 2x5,5 kg | Pal 40 | Ctr 20ft 2000 pcs

DÉCAPAGE  
STRIPPING

ÉLECTROPORTATIF  
HANDPOWER TOOLS

X-FIT  
RANGE

ATELIER  
WORKSHOP

BOIS  
WOOD MACHINES

MÉTAL  
METAL MACHINES

NETTOYAGE  
CLEANING

CONSTRUCTION  
BUILDING

JARDIN FLAIRE  
GARDEN TOOLS

Plus d'info sur  
**far.tools.com**



# Surfaceuse multi-matériaux - Multi materials surfer - PMF 1300

ø 125/150 mm  
1400 Watts



Polissage automobile (ø 150 mm)  
Polishing



Décapage du métal (ø 75 mm)  
Metal cleaning



Meulage du métal (ø 125 mm)  
Metal grinding



Surfaceuse béton (ø 125 mm)  
Concrete surfer

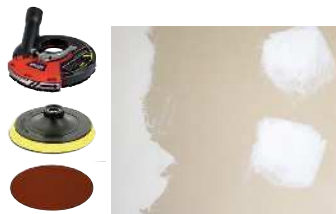

Ponçage du plâtre avec aspiration  
Plaster sanding with suction



Ponçage du bois (ø 125 mm)  
Wood sanding



«Travail en bordure  
-> Evite la poussière.  
Très bon produit,  
polyvalent,  
bonne prise en main.»  
Damien M.

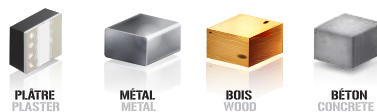

- ▶ **Multifonctions : multimatériaux**  
Multifunctions: multimaterials
- ▶ **Ponçage en bordure**  
Edge sanding
- ▶ **Poignée ajustable et ergonomique**  
Adjustable and ergonomic handle
- ▶ **Connectable à un aspirateur à décolmatage**  
Connectable to a unclogging vacuum cleaner
- ▶ **Carter indexable sans outils**  
Case to be swivelled without a tool
- ▶ **Variateur de vitesse électronique**  
Electronic variable speed



Livrée en mallette avec 8 accessoires  
Delivered in BMC with 8 accessories



Surfaceuse multi-matériaux - Multi materials surfer	PMF 1300
Gencode	3431541150324
Puissance du moteur - Motor power (230V-50Hz)	1400 W
Variateur de vitesse électronique - Electronic variable speed	3000 - 10000 min <sup>-1</sup>
Dimensions disque (ponçage-meulage) - Disc sizes (sanding - grinding)	ø 125 x 22,2 mm
Dimensions du disque (polissage - lustrage) - Disc sizes (polishing - finishing)	ø 150 mm
Diamètre de l'arbre - Arbor diameter	M14
Blocage d'arbre - Arbor lock	OK

### Données logistiques - Logistic informations

3 431541150324 Box 1100x260x260 mm | Master 1 x 4,4 kg | Pal 18 pcs | Ctr 20ft 330 pcs

### Consommables - Consumables

Disque béton - Concrete disc	3431541158894
Set 6 abrasifs : 2xA80 / 2x120 / 2x180 - 6 Abrasive pads	3431541159174
Brosse ø 100 mm - 100 mm brush	3431547500376

# Ponceuse surfaceuse à béton - Resurfacing floor sander - PSB 1300

ø 180 mm  
1300 Watts



Aspiration autonome des poussières  
Autonomous dust collector



Carter escamotable  
Retractable housing

- ▶ **Aspiration autonome des poussières.**  
Autonomous dust extraction
- ▶ **Carter escamotable, pour le ponçage en bordure**  
Retractable housing for sanding edge
- ▶ **Poignée avant orientable**  
Adjustable front handle
- ▶ **Variateur de vitesse**  
Variable speed
- ▶ **Event de réglage de l'aspiration**  
Suction adjustment vent
- ▶ **Flexible 2 m et sac à poussières**  
2 m hose and dust bag

Livrée avec disque ø 180 mm, clef de serrage, flexible et sac à poussières  
Delivered with ø 180 mm disc, key, hose and dust bag



**DUST**  
Collector



**RUBBER**  
Grip



**SPEED**  
Control



**Arbor**  
Lock



**SOFT**  
Start

Ponceuse surfaceuse à béton - Concrete resurfacer	<b>PSB 1300</b>
Gencode	<b>3431541151901</b>
Puissance du moteur - Motor power (230V-50Hz)	<b>1300 W</b>
Variateur de vitesse électronique - Electronic variable speed	<b>800-1750 tr.min<sup>-1</sup></b>
Dimensions disque (ponçage-meulage) - Disc sizes (sanding - grinding)	<b>ø 180 mm</b>
Diamètre de l'arbre - Arbor diameter	<b>M14</b>
Données logistiques - Logistic informations	
3 431541 1151901   Box 580x240x270 mm   Master 1 x 4,3 kg   Pal 36 pcs   Ctr 20ft 1100 pcs	
Consommables - Consumables	
Disque diamant - Do-iamond disc	<b>3431541159408</b>

DÉCAPAGE  
STRIPPING

ÉLECTROPORATIF  
HANDPOWER TOOLS

X-FIT  
RANGE

ATELIER  
WORKSHOP

BOIS  
WOOD MACHINES

MÉTAL  
METAL MACHINES

NETTOYAGE  
CLEANING

CONSTRUCTION  
BUILDING

JARDIN FILAIRE  
GARDEN TOOLS

Plus d'info sur  
**far**tools.com

# Malaxeur - Mixer - MI 1200D

1400 W  
27 N/m

**NOUVEAU**



- ▶ Pour matériaux légers : peinture, enduit fin...  
For light materials: paints, light coated end...
- ▶ Poignée en haut du moteur pour travail droit  
Handle at the top of the engine for right work
- ▶ Ample poignées renforcées / caoutchouc  
Big reinforced handles / rubber
- ▶ 2 vitesses mécaniques  
2 mechanical speeds
- ▶ Variateur de vitesse électronique  
Electronic variable speed

Livré en sac de transport avec accessoires  
Delivered in carrying bag with accessories



Résultat homogène  
Homogeneous result



**SPEED**  
Control



**2 Speeds**  
2 Vitesses



**RUBBER**  
Grip

Malaxeur - Mixer	MI 1200D
Gencode	3431541165502
Puissance du moteur - Motor power (230V-50Hz)	1400 W 27 Nm
Mixeur spirale - Spiral mixer	M14 - ø 120mm
Vitesse de rotation - Rotation speed	240-500 tr.min <sup>-1</sup> 380-850 tr.min <sup>-1</sup>
Données logistiques - Logistic informations	



3 431541 165502

Box 450x350x240 mm | Master 2 x 8,1 kg | Pal 24 pcs | Ctr 20ft 660 pcs

# Malaxeur - Mixer - MI 1800B

1800 W  
38 N/m

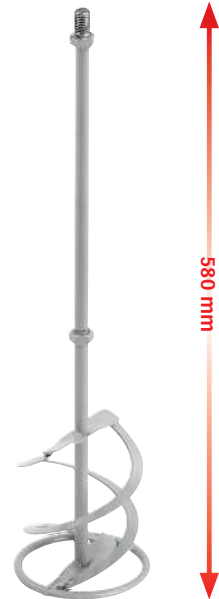

- ▶ **Pour matériaux forte densité** : crépis, plâtre, mortiers, colle...  
For high density materials: plastered, plaster, mortar, glue...
- ▶ **Poignées ergonomiques**  
Ergonomic handles
- ▶ **Poignée métallique** = solidité, avec angle anti-casse  
Metal handle = Solidity, with anti-breakage angle
- ▶ **2 vitesses mécaniques**  
2 mechanical speeds
- ▶ **Variateur de vitesse électronique**  
Electronic variable speed

Livré en sac de transport avec accessoires  
Delivered in carrying bag with accessories



**SPEED**  
Control



**2 Speeds**  
2 Vitesses



**RUBBER**  
Grip



Résultat homogène  
Homogeneous result

Malaxeur - Mixer	MI 1800B
Gencode	<b>3431541165533</b>
Puissance du moteur - Motor power (230V-50Hz)	<b>1800 W</b> <b>38Nm</b>
Mixeur spirale - Spiral mixer	<b>M14 - ø 160mm</b>
Vitesse de rotation - Rotation speed	<b>0-430 tr.min<sup>-1</sup></b> <b>0-750 tr.min<sup>-1</sup></b>

Données logistiques - Logistic informations



3 431541 165533

Box 450x320x225 mm | Master 2 x 8,5 kg | Pal 30 pcs | Ctr 20ft 560 pcs

DÉCAPAGE  
STRIPPING

ÉLECTROPORTATIF  
HANDPOWER TOOLS

X-FIT  
RANGE

ATELIER  
WORKSHOP

BOIS  
WOOD MACHINES

MÉTAL  
METAL MACHINES

NETTOYAGE  
CLEANING

CONSTRUCTION  
BUILDING

JARDIN FILAIRE  
GARDEN TOOLS

Plus d'info sur  
**fartools.com**

# Vibreux à béton - Concrete vibrator - VB 1200

1100 W  
1,25 m

**PRODUIT MALIN**  
SMART PRODUCT

AIGUILLE VIBRANTE L 2 M, Ø 35 MM  
VIBRATING NEEDLE L 2 M, Ø 35 MM



3431541165618



«Mon béton sans bulle d'air est plus résistant. Parfait pour la maçonnerie»  
Diarmuid D.

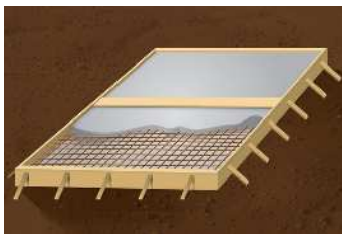

Terrasse béton  
Concrete terrace

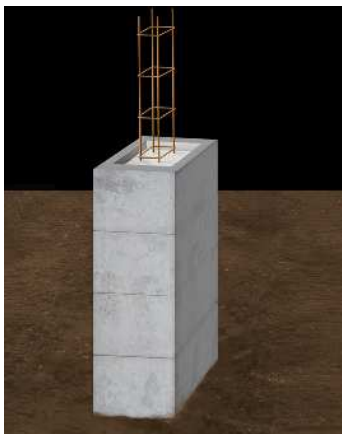

Remplissage de pilier  
Pillar filling

- ▶ **Pervibration du béton (serrage) : permet l'évacuation des bulles d'air en comblant les interstices pour compacter le béton.**  
Concrete pervibration (tightening): allows the evacuation of air bubbles in your concrete and allows it to have the ideal consistency
- ▶ **Permet d'obtenir un béton lisse et régulier (béton coffré)**  
Allows to obtain a smooth and clean concrete (boxed concrete)
- ▶ **Assure une parfaite homogénéité du béton**  
Ensures perfect homogeneity of the concrete
- ▶ **Interrupteur bloquant pour plus de confort**  
Blocking switch for more comfort
- ▶ **Aiguille flexible 1,25 mètre, diamètre 35 mm**  
Flexible needle 1,25 meter, diameter 35mm
- ▶ **Prise de protection contre les surtensions**  
Surge protection socket



Vibreux à béton - Concrete vibrator	VB 1200
Gencode	3431541165601
Puissance du moteur - Motor power (230V-50Hz)	1100 W
Vitesse de rotation - Rotation speed	4400 tr.min <sup>-1</sup>
Dimensions aiguille - Needle sizes	1,25 m - Ø 35 mm
Amplitude de vibration - Vibration amplitude	≥ 1,2 mm

Données logistiques - Logistic informations



Box 310x295x230 mm | Master 1 x 6,5 kg | Pal 36 pcs | Ctr 20ft 780 pcs

Consommables - Consumables

Aiguille flexible 2 m / Ø 35 mm - Concrete shaft 2.0 m / Ø 35 mm

3431541165618

# Règle vibrante à béton - Concrete vibration ruler - RV 300

240 W  
1 m



Terrasse béton  
Concrete terrace



Prise de protection contre les surtensions  
PRCD socket

- ▶ **Lissage du béton rapide et précis par vibration mécanique**  
Fast and precise concrete smoothing using mechanical vibration
- ▶ Permet d'obtenir un béton lisse et régulier (chape de béton)  
Allows to obtain a smooth and clean concrete (concrete screed)
- ▶ Mise à niveau du béton automatique  
Automatic Concrete Leveling
- ▶ 2 vitesses de vibration pour s'adapter à l'hygrométrie du béton  
2 vibration speeds to adapt to the humidity of the concrete
- ▶ Règle aluminium 1 mètre  
Aluminium ruler 1 meter
- ▶ Prise de protection contre les surtensions  
Surge protection socket

Règle vibrante à béton - Concrete vibration ruler	<b>RV 300</b>
Gencode	<b>3431541150911</b>
Puissance du moteur - Motor power (230V-50HZ)	<b>240 W</b>
Vitesse de vibration - Vibration speed	<b>600 / 12000 cps/min</b>
Dimensions règle - Ruler sizes	<b>1 m</b>
Données logistiques - Logistic informations	



Box 300x250x500 mm | Master 1 x 8,5 kg | Pal 30 pcs | Ctr 20ft 300 pcs

DÉCAPAGE  
STRIPPING

ÉLECTROPORATIF  
HANDPOWER TOOLS

X-FIT  
RANGE

ATELIER  
WORKSHOP

BOIS  
WOOD MACHINES

MÉTAL  
METAL MACHINES

NETTOYAGE  
CLEANING

CONSTRUCTION  
BUILDING

JARDIN FILAIRE  
GARDEN TOOLS

Plus d'info sur  
**far.tools.com**

## Récupérateur de poussières pour perceuse - *Dust collector*

ø 16 mm maxi



**ASPIRATION**  
— EFFET VENTOUSE —  
**100% D'EFFICACITÉ**

- ▶ Effet ventouse sur support à percer  
>> Permet de libérer les mains  
Suction cup effect on support to be drilled  
>> Helps free your hands
- ▶ Compatible toutes perceuses visseuses  
For all cordless drills
- ▶ Compatible flexible d'aspirateur de ø 26 à 39 mm  
Compatible vacuum cleaner hose from ø 26 to 39 mm



Gencode **3431541159228**

Données logistiques - *Logistic informations*



Box 235x80x35 mm | Master 40x1,6 kg  
Pal 3500 | Ctr 20ft 25000 pcs

## Récupérateur de gravats pour marteau perforateur - *Dust collector*

ø 70 mm maxi



**ASPIRATION**  
— EFFET VENTOUSE —  
**100% D'EFFICACITÉ**

- ▶ Effet ventouse sur support à percer  
>> Permet de libérer les mains  
Suction cup effect on support to be drilled  
>> Helps free your hands
- ▶ Compatible tous marteaux perforateurs  
For all rotary hammers
- ▶ Compatible flexible d'aspirateur de ø 26 à 39 mm  
Compatible vacuum cleaner hose from ø 26 to 39 mm



Gencode **3431541159235**

Données logistiques - *Logistic informations*



Box 295x125x100 mm | Master 30x1,9 kg  
Pal 300 | Ctr 20ft 20000 pcs

# L'univers du Plaquiste

Plasterboard range

PRÉPARATION - OSSATURE MÉTALLIQUE - PLAQUE DE PLÂTRE - ENDUIT - PONÇAGE



DÉCAPAGE  
STRIPPING

ÉLECTROPORTATIF  
HANDPOWER TOOLS

X-FIT  
RANGE

ATELIER  
WORKSHOP

BOIS  
WOOD MACHINES

MÉTAL  
METAL MACHINES

NETTOYAGE  
CLEANING

PLAQUISTE  
PLASTERBOARDER

JARDIN FILAIRE  
GARDEN TOOLS

Plus d'info sur  
[fartools.com](http://fartools.com)



# Offre complète de 1 à 2 mètres linéaires

Complete offer from 1 to 2 meters linear



# Ponceuse orbitale plaque de plâtre - Orbital drywall sander - DWS 180E

ø 180 mm  
900 Watts

**NOUVEAU**



Éclairage LED : idéal pour voir les défauts de planéité  
LED lighting: usefull to see plasterboard coating defects

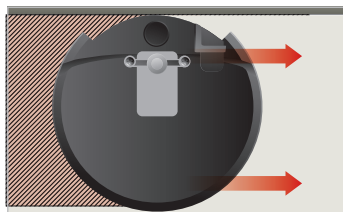

Ponçage en bordure  
Edging sanding

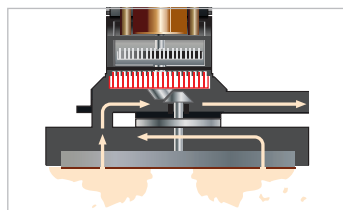

Aspiration autonome  
Independant fan

- ▶ Eclairage LED : idéal pour voir les défauts de planéité  
LED lighting: ideal for viewing flatness defects
- ▶ Récupération des poussières par aspiration autonome  
Dust collection by independent aspiration
- ▶ Effet ventouse = grande étanchéité pour une meilleure évacuation des poussières  
Suction effect = great sealing for better dust removal
- ▶ Trappe escamotable = ponçage d'angles et bordures  
Retractable door = corner and edge sanding
- ▶ Plateau 180 mm avec fixation auto agrippante  
Tray 180 mm with auto fastening fixing
- ▶ Variateur de vitesse électronique  
Electronic variable speed
- ▶ Poignée frontale  
Front handle
- ▶ Poignée latérale gauche / droite  
Left / right side handle



Livrée en sac textile avec tube flexible (4 m), sac à poussières, 6 abrasifs  
Delivered in nylon bag with flexible tube (4 m), dust bag, 6 abrasives



**RUBBER**  
Grip



**SPEED**  
Control



**VELCRO**



**Dust**  
Collector



**LED**  
Light

Ponceuse orbitale à plaque de plâtre - Orbital drywall sander	DWS 180E
Gencode	3431541151659
Puissance du moteur - Motor power (230V-50Hz)	900 W
Variateur de vitesse électronique - Electronic speed variator	1400 - 2700 tr.min <sup>-1</sup>
Dimension du disque - Disc size	ø 180 mm
Diamètre et longueur du tuyau Hose diameter and length	ø 38 mm 4 m
Aspirateur à plâtre - Plaster vacuum cleaner (p 184)	3431541012134
Aspirateur à plâtre - Plaster vacuum cleaner (p 183)	3431541012110

Données logistiques - Logistic informations



Box 420x250x265 mm | Master 4 x 4,65 kg | Pal 40 pcs | Ctr 20ft 1000 pcs

Consommables - Consumables

6 Abrasifs A80/100/120/150/180/240 Velcro - Abrasives	3431541158825
6 Abrasifs A80 Velcro - Abrasives	3431541159358
6 Abrasifs A120 Velcro - Abrasives	3431541159365
6 Abrasifs A180 Velcro - Abrasives	3431541159372
6 Abrasifs A240 Velcro - Abrasives	3431541158771

DÉCAPAGE  
STRIPPING

ÉLECTROPORTATIF  
HANDPOWER TOOLS

X-FIT  
RANGE

ATELIER  
WORKSHOP

BOIS  
WOOD MACHINES

MÉTAL  
METAL MACHINES

NETTOYAGE  
CLEANING

PLAQUISTE  
PLASTERBOARDER

JARDIN FLAIRE  
GARDEN TOOLS

Plus d'info sur  
**far**  
**tools.com**

# Ponceuse orbitale à plaque de plâtre - *Orbital drywall sander* - DWF 225

ø 225 mm  
1200 Watts

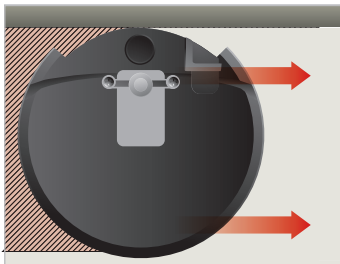

Ponçage en bordure  
Edging sanding

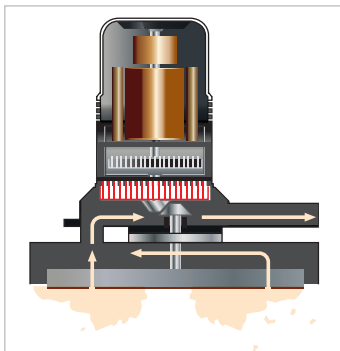

Aspiration autonome  
Independent fan

- ▶ **Récupération des poussières par aspiration autonome**  
Dust collection by independent aspiration
- ▶ **Effet ventouse = grande étanchéité pour une meilleure évacuation des poussières**  
Suction effect = great sealing for better dust removal
- ▶ **Trappe escamotable = ponçage d'angles et bordures**  
Retractable door = corner and edge sanding
- ▶ **Large plateau de 225 mm = spécial grandes surfaces**  
Large tray of 225 mm = special large surfaces
- ▶ **Plateau 255 mm avec fixation auto agrippante**  
Tray 255 mm with auto fastening fixing
- ▶ **Variateur de vitesse électronique**  
Electronic variable speed
- ▶ **Poignée latérale gauche et droite**  
Left and right side handle

Livrée avec tube flexible, sac à poussières, 6 abrasifs  
Delivered with flexible tube, dust bag, 6 abrasives



**RUBBER**  
Grip



**SPEED**  
Control



**VELCRO**



**Dust**  
Collector

Ponceuse orbitale à plaque de plâtre - <i>Orbital drywall sander</i>	<b>DWF 225</b>
Gencode	<b>3431541151680</b>
Puissance du moteur - <i>Motor power (230V-50Hz)</i>	<b>1200 W</b>
Variateur de vitesse électronique - <i>Electronic speed variator</i>	<b>1400 - 3100 tr.min<sup>-1</sup></b>
Dimension du disque - <i>Disc size</i>	<b>ø 225 mm</b>
Diamètre et longueur du tuyau - <i>Hose diameter and length</i>	<b>ø 38 mm 2 m</b>
Aspirateur à plâtre - <i>Plaster vacuum cleaner (p 184)</i> Aspirateur à plâtre - <i>Plaster vacuum cleaner (p 183)</i>	<b>3431541012134</b> <b>3431541012110</b>
<b>Données logistiques - Logistic informations</b>	
Box 275x275x280 mm   Master 4 x 4,8 kg   Pal 40 pcs   Ctr 20ft 1260 pcs	
<b>Consommables - Consumables</b>	
6 Abrasifs A80/100/120/150/180/240 Velcro - Abrasives	<b>3431541158955</b>
6 Abrasifs A80 Velcro - Abrasives	<b>3431541158962</b>
6 Abrasifs A120 Velcro - Abrasives	<b>3431541158979</b>
6 Abrasifs A180 Velcro - Abrasives	<b>3431541158986</b>
6 Abrasifs A240 Velcro - Abrasives	<b>3431541158993</b>
6 Abrasifs maille - Abrasives	<b>3431541159105</b>
Plateau de ponçage M14 - Sanding Pad M14	<b>3431541134843</b>

# Ponceuse orbitale à plaque de plâtre - Orbital drywall sander - DWS 800C

ø 225 mm  
1010 Watts

**NOUVEAU**



Éclairage LED : idéal pour voir les défauts de planéité  
LED lighting: usefull to see plasterboard coating defects

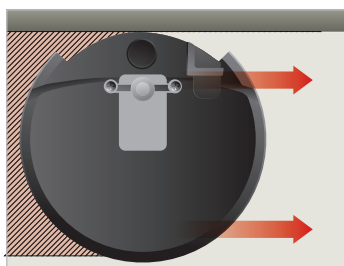

Ponçage en bordure  
Edging sanding



Connexion à un aspirateur spécial plâtre  
Special plasterboard vacuum cleaner

- ▶ **Effet ventouse** = grande étanchéité pour une meilleure évacuation des poussières  
Suction effect = great sealing for better dust removal
- ▶ **Éclairage LED** : idéal pour voir les défauts de planéité  
LED lighting: ideal for viewing flatness defects
- ▶ **Récupération des poussières par aspiration autonome**  
Dust collection by independent aspiration
- ▶ **Trappe escamotable = ponçage d'angles et bordures**  
Retractable door = corner and edge sanding
- ▶ **Plateau 225 mm avec fixation auto agrippante**  
Tray 225 mm with auto fastening fixing
- ▶ **Variateur de vitesse électronique**  
Electronic variable speed
- ▶ **Tube flexible = connexion à un aspirateur**  
Flexible tube = connection to a vacuum cleaner
- ▶ **Poignée auxiliaire frontale**  
Front auxiliary handle

Livrée avec tube flexible (1,5 m), sac à poussières et 6 abrasifs  
Delivered with 1,5 m flexible tube, dustbag and 6 abrasives



**RUBBER**  
Grip



**SPEED**  
Control



**VELCRO**



**Dust**  
Collector



**LED**  
Light

Ponceuse orbitale à plaque de plâtre - Orbital drywall sander	DWS 800C
Gencode	<b>3431541151628</b>
Puissance du moteur - Motor power (230V-50Hz)	<b>1010 W</b>
Variateur de vitesse électronique - Electronic speed variator	<b>1000 - 1950 tr.min<sup>-1</sup></b>
Dimension du disque - Disc size	<b>ø 225 mm</b>
Diamètre et longueur du tuyau - Hose diameter and length	<b>ø 38 mm 1,5 m</b>
Aspirateur à plâtre - Plaster vacuum cleaner (p 184)	<b>3431541012134</b>
Aspirateur à plâtre - Plaster vacuum cleaner (p 183)	<b>3431541012110</b>
Données logistiques - Logistic informations	
Box 575x315x240 mm   Master 2 x 4 kg   Pal 32 pcs   Ctr 20ft 750 pcs	



3 431541 1151628

Box 575x315x240 mm | Master 2 x 4 kg | Pal 32 pcs | Ctr 20ft 750 pcs

Consommables - Consumables	
6 Abrasifs A80/100/120/150/180/240 Velcro - Abrasives	<b>3431541158955</b>
6 Abrasifs A80 Velcro - Abrasives	<b>3431541158962</b>
6 Abrasifs A120 Velcro - Abrasives	<b>3431541158979</b>
6 Abrasifs A180 Velcro - Abrasives	<b>3431541158986</b>
6 Abrasifs A240 Velcro - Abrasives	<b>3431541158993</b>
6 Abrasifs maille - Abrasives	<b>3431541159105</b>
Plateau de ponçage M14 - Sanding Pad M14	<b>3431541134843</b>

DÉCAPAGE  
STRIPPING

ÉLECTROPORATIF  
HANDPOWER TOOLS

X-FIT  
RANGE

ATELIER  
WORKSHOP

BOIS  
WOOD MACHINES

MÉTAL  
METAL MACHINES

NETTOYAGE  
CLEANING

PLAQUISTE  
PLASTERBOARDER

JARDIN FILAIRE  
GARDEN TOOLS

Plus d'info sur  
**fartools.com**

# Ponceuse orbitale à plaque de plâtre - *Orbital drywall sander* - **DWS 710E**

ø 225 mm  
710 Watts



- ▶ **Tube télescopique pliable** : transport et rangement facile  
Foldable telescopic tube: easy transport and storage
- ▶ **Trappe escamotable = ponçage d'angles et bordures**  
Retractable door = corner and edge sanding
- ▶ **Poignée de préhension = ponçage au plafond**  
Gripping handle = ceiling sanding
- ▶ **Système de blocage à 90° pour les plafonds**  
90° locking system for ceiling
- ▶ **Plateau 225 mm avec fixation auto agrippante**  
Tray 225 mm with auto fastening fixing
- ▶ **Variateur de vitesse électronique**  
Electronic variable speed
- ▶ **Tête inclinable et orientable**  
Tilt and swivel head
- ▶ **Flexible d'extraction de poussières extensible 4 m**  
4 m expandable dust extraction hose
- ▶ **Pièce de protection flexible / machine posée contre le mur**  
Flexible protection piece / machine placed against the wall  
*Delivered folded with 6 abrasives, 1 flexible d'aspiration de 4 m, 1 adaptateur d'aspirateur*



Ponçage en bordure  
Edging sanding

Ponceuse orbitale à plaque de plâtre - <i>Orbital drywall sander</i>	<b>DWS 710E</b>
Gencode	<b>3431541151598</b>
Puissance du moteur - <i>Motor power (230V-50Hz)</i>	<b>710 W</b>
Variateur de vitesse électronique - <i>Electronic speed variator</i>	<b>600 - 1500 tr.min<sup>-1</sup></b>
Dimension du disque - <i>Disc size</i>	<b>ø 225 mm</b>
Diamètre et longueur du tuyau - <i>Hose diameter and length</i>	<b>ø 38 mm 1,5 m</b>
Aspirateur à plâtre - <i>Plaster vacuum cleaner (p 184)</i>	<b>3431541012134</b>
Aspirateur à plâtre - <i>Plaster vacuum cleaner (p 183)</i>	<b>3431541012110</b>
<b>Données logistiques - Logistic informations</b>	

3 431541151598 | Box 680x270x240 mm | Master 2 x 6,10 kg | Pal 28 pcs | Ctr 20ft 560 pcs

<b>Consommables - Consumables</b>	
6 Abrasifs A80/100/120/150/180/240 Velcro - Abrasives	<b>3431541158955</b>
6 Abrasifs A80 Velcro - Abrasives	<b>3431541158962</b>
6 Abrasifs A120 Velcro - Abrasives	<b>3431541158979</b>
6 Abrasifs A180 Velcro - Abrasives	<b>3431541158986</b>
6 Abrasifs A240 Velcro - Abrasives	<b>3431541158993</b>
6 Abrasifs maille - Abrasives	<b>3431541159105</b>
Plateau de ponçage M14 - Sanding Pad M14 (V1-V4)	<b>3431541134843</b>
Plateau de ponçage - Sanding Pad (V5)	<b>3431541134850</b>

# Aspirateur eau et poussières - Vacuum cleaner - NETUP 30PB

18 kpa  
1200W

**SPECIAL**  
plâtre et gravat  
plaster and rubble

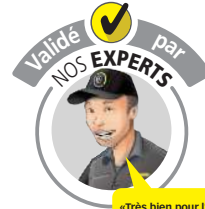

«Très bien pour l'aspiration de gravats ou de poussières.»  
Laurent L.



Décolmatage mécanique  
Mechanical cleaning



Décolmatage manuel par brosse  
Manual cleaning by brushing



Prise asservie  
Synchronized socket

- ▶ **Décolmatage manuel par brosse**  
Manual cleaning by brushing
- ▶ **Prise asservie temporisée : démarrage 3s / Arrêt différé 8s**  
3s / 8s timer power socket: delayed start 3s / Delayed stop 8s
- ▶ **Vidange de cuve**  
Draining tank
- ▶ **Fonction souffleur**  
Blower function
- ▶ **Cuve inox 30 L eau et poussière**  
30 L inox tank water and dust
- ▶ **Tube télescopique + rallonge métal avec réglage du débit d'air**  
Metal telescopic tube + extension with air flow adjustment

Livré avec filtre cartouche, bonnette, sac à poussières, adaptateur, brosse étagère, brosse large, suceur et rallonge de tube.  
Delivered with cartridge filter, windscreen, dust bag, adaptor, shelf brush, broad brush, squeegee



x 4 **Blowing**  
Souffleur



**Air flow**  
Débit d'air



**Raccord**  
Tournant



**Prise**  
Asservie



**WET&DRY**

YouTube



Aspirateur eau et poussières - Vacuum cleaner		<b>NETUP 30PB</b>
Gencode	<b>3431541012110</b>	
Puissance du moteur - Motor power (230V~50Hz)	1200 W <b>18 kpa - 108m³/h</b>	
Volume de la cuve - Tank volume	30 L <b>Inox</b>	
Longueur du tuyau - Hose length	ø 35 mm 2,5 m	

Données logistiques - Logistic informations



Box 360x360x595 mm | Master 1 x 7,30 kg | Pal 16 | Ctr 20ft 345 pcs

Consommables - Consumables

Filtre cartouche papier - Paper cartridge filter

**3431541018297**

Sac a poussières - Dustbags

**3431541018341**

DÉCAPAGE  
STRIPPING

ÉLECTROPORATIF  
HANDPOWER TOOLS

X-FIT  
RANGE

ATELIER  
WORKSHOP

BOIS  
WOOD MACHINES

MÉTAL  
METAL MACHINES

NETTOYAGE  
CLEANING

PLAQUISTE  
PLASTERBOARDER

JARDIN FILAIRE  
GARDEN TOOLS

Plus d'info sur  
**fartools.com**

# Ponceuse orbitale à plaque de plâtre - *Orbital drywall sander* - **DWS 750**

ø 225 mm  
750 Watts



- ▶ **Eclairage LED** : Idéal pour voir les défauts de planéité  
LED lighting : Usefull to see plasterboard coating defects
- ▶ **Aspiration autonome (turbine intégrée)**  
Independent aspiration (integrated turbine)
- ▶ **Système de blocage d'angle pour les plafonds et sous pente**  
Corner locking system for ceilings and sloping ceilings
- ▶ **Plateau orientable à 360°** : positionnement de la trappe à l'endroit voulu  
360° swivel plate: positioning of the hatch in the desired location
- ▶ **Trappe escamotable = ponçage d'angles et bordures**  
Retractable door = corner and edge sanding
- ▶ **Poignée de préhension = ponçage au plafond**  
Gripping handle = ceiling sanding
- ▶ **Tube télescopique pliable** : transport et rangement facile  
Foldable telescopic tube: easy transport and storage

Livrée pliée avec 1 flexible d'aspiration de 1 à 4 m, 6 abrasifs, 3 disques mailles, en sac de transport  
Delivered folded with 1 suction hose of 1 to 4 m, 6 abrasives, 3 mesh discs, in nylon bag



Ponceuse orbitale à plaque de plâtre - <i>Orbital drywall sander</i>	<b>DWS 750</b>
Gencode	<b>3431541151734</b>
Puissance du moteur - <i>Motor power (230V-50Hz)</i>	<b>750 W</b>
Variateur de vitesse électronique - <i>Electronic speed variator</i>	<b>900 - 1800 tr.min<sup>-1</sup></b>
Dimension du disque - <i>Disc size</i>	<b>ø 225 mm</b>
Tube télescopique - <i>Telescopic tube</i>	<b>1500 - 1800 mm</b>
Diamètre et longueur du tuyau - <i>Hose diameter and length</i>	<b>ø 32 mm / 4 m</b>
Aspirateur à plâtre - <i>Plaster vacuum cleaner (p 184)</i>	<b>3431541012134</b>
Aspirateur à plâtre - <i>Plaster vacuum cleaner (p 183)</i>	<b>3431541012110</b>
<b>Données logistiques - Logistic informations</b>	

Box 770x280x260 mm | Master 1 x 6,94 kg | Pal 20 pcs | Ctr 20ft 500 pcs

<b>Consommables - Consumables</b>	
6 Abrasifs A80/100/120/150/180/240 Velcro - Abrasives	<b>3431541158955</b>
6 Abrasifs A80 Velcro - Abrasives	<b>3431541158962</b>
6 Abrasifs A120 Velcro - Abrasives	<b>3431541158979</b>
6 Abrasifs A180 Velcro - Abrasives	<b>3431541158986</b>
6 Abrasifs A240 Velcro - Abrasives	<b>3431541158993</b>
6 Abrasifs maille - Abrasives	<b>3431541159105</b>
Plateau de ponçage - Sanding Pad	<b>3431541134867</b>

Ponçage en bordure, orientable à 360°  
Edging sanding, 360°

# Aspirateur eau et poussières - Vacuum cleaner - MF 35PLASTER

20 kpa  
1600W

**SPECIAL**  
plâtre et gravat  
plaster and rubble

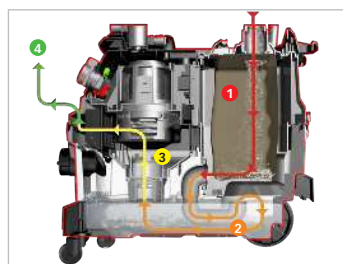
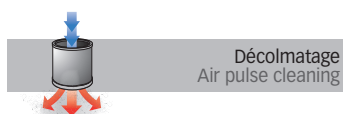

3 niveaux de filtration  
3 filtration levels



Fonction PLÂTRE  
PLASTER function

- ▶ **Système multi filtre en série pour toutes poussières et eaux**  
Multi filter system in series for all dust and water
  - ▶ **Double entrée d'aspiration**  
Double suction inlet
  - ▶ **Prise asservie temporisée : démarrage instantané / arrêt différé 10 s**  
Timed slave socket: instantaneous start / 10 s delayed stop
  - ▶ **Fonction décolmatage manuel**  
Manual unclogging function
  - ▶ **Fonction souffleur variable = pratique pour repousser la poussière**  
Variable blower function = ideal to repel dust
  - ▶ **Poignée type trolley rétractable**  
Retractable trolley-type handle
  - ▶ **Variateur du débit d'air pour l'aspirateur ou le souffleur**  
Air flow controller for the vacuum cleaner or blower
- Livré avec 2 filtres cartouche, 2 sacs en tissu, tube inox, 2 suceurs larges, 1 brosse ronde, 1 adaptateur, 1 suceur long.  
Supplied with 2 cartridge filters, 2 fabric bags, stainless steel tube, 2 wide nozzles, 1 round brush, 1 adapter, 1 long nozzle.



x 4

**Blowing**

Souffleur



**Air flow**

Débit d'air



**SPEED**

Control



**Prise**

Asservie



**WET&DRY**

Aspirateur eau et poussières - Vacuum cleaner

MF 35PLASTER

Gencode

3431541012134

Puissance du moteur - Motor power (230V-50Hz)

1600 W

Volume de la cuve - Tank volume

20 kpa

35 L

Longueur du tuyau - Hose length

PVC

ø 32 mm

2 m

Données logistiques - Logistic informations



Box 610x375x575 mm | Master 1 x 16,45 kg | Pal 10 | Ctr 20ft 216 pcs

Consommables - Consumables

Filtere cartouche mousse - Foam cartridge filter

3431541018563

Filtere cartouche - Cartridge filter

3431541018570

Sac toile pour cuve - Fabric bag for tank

3431541018587

Sac a poussières extérieur - Exterior bag for tank

3431541018594

DÉCAPAGE  
STRIPPING

ÉLECTROPORATIF  
HANDPOWER TOOLS

X-FIT  
RANGE

ATELIER  
WORKSHOP

BOIS  
WOOD MACHINES

MÉTAL  
METAL MACHINES

NETTOYAGE  
CLEANING

PLAQUISTE  
PLASTERBOARDER

JARDIN FILAIRE  
GARDEN TOOLS

Plus d'info sur  
fartools.com



**NOUVEAU**



Branchement en série jusqu'à 1650 W  
Series connection until 1650 W



Clipsable en série  
Serial clip on

▶ **3 Inclinaisons de travail différentes : Plafonds, murs et raz des sols**  
**3 different working inclinations : ceiling, walls and floors**

▶ **3 Vitesses de travail**

3 working speeds

▶ Branchement jusqu'à 11 ventilateurs en série - 1650 W maxi

Connection of up to 11 fans in series - 1650 W max

▶ Emplacement pour enroulement du câble

Location for cable winding

▶ Poignée de transport

Transportation handle

▶ 4 mètres de câble et léger: facile à déplacer sur vos chantiers

4 meters of cable and lightweight: easy to move around your construction sites



Souffleur de sol et murs - Floor and wall blower	<b>SAS 150</b>
Gencode	<b>3431541153455</b>
Puissance du moteur - Motor power (230V-50Hz)	<b>150 W</b>
Vitesses de soufflerie - blowing speed	<b>523 m<sup>3</sup>/h 648 m<sup>3</sup>/h 713 m<sup>3</sup>/h</b>
Capacité de branchement maximum (nombre de machines + puissance) Maximum connection capacity (number of machines + power)	<b>x 11 1650 W</b>
Inclinaisons du ventilateur Fan Tilts	<b>0° - 45° - 90°</b>
Données logistiques - Logistic informations	



3 431541 1153455

Box 1125x430x390 mm | Master 1x35,8 kg | Pal 8 pcs | Ctr 20ft 158 pcs

# Visseuse à plaque de plâtre - Plasterboard drill - PM 6C

520 Watts



EXISTE AUSSI EN VERSION BATTERIE  
ALSO AVAILABLE IN BATTERY VERSION



- ▶ **Vissage en continu** : alimentation secteur  
Continuous screwing: mains supply
- ▶ **Câble caoutchouc** : plus résistant  
Rubber cable: more resistant
- ▶ **Machine très légère**: 1,6 kg  
Very light machine: 1,6 kg
- ▶ **Débrayage automatique**  
Automatic disengagement
- ▶ **Crochet à la ceinture**  
Belt clip
- ▶ **Bague de réglage de la butée de profondeur** (embout de vissage standard 25 mm)  
Depth adjusting ring (standard screw bit 25 mm)
- ▶ **Grande longueur de câble** : 2 m = liberté de mouvement dans le travail  
Long cable length: 2 m = freedom of movement in work

Livré avec embouts de vissage type PH1, PH2 et PH3  
Supplied with PH1, PH2 and PH3 screw types



**RUBBER**  
Grip



**SPEED**  
Control



**REVERSE**  
Réversible

Visseuse à plaque de plâtre - Plasterboard drill

PM 6C

Gencode

3431541150096

Puissance du moteur - Motor power (230V-50Hz)

520 W

Variateur de vitesse électronique - Electronic speed variator

0-4200 tr.min<sup>-1</sup>

Longueur de câble - Cable length

2 m - Caoutchouc  
2 m - Rubber

Données logistiques - Logistic informations



Box 250x80x310 mm | Master 10 x 1,75 kg | Pal 150 pcs | Ctr 20ft 5230 pcs

3 431541 150096

DÉCAPAGE  
STRIPPING

ÉLECTROPORATIF  
HANDPOWER TOOLS

X-FIT  
RANGE

ATELIER  
WORKSHOP

BOIS  
WOOD MACHINES

MÉTAL  
METAL MACHINES

NETTOYAGE  
CLEANING

PLAQUISTE  
PLASTERBOARDER

JARDIN FILAIRE  
GARDEN TOOLS

Plus d'info sur  
**fartools.com**

# Couteau à matériaux isolants - knife for insulating materials

280 mm

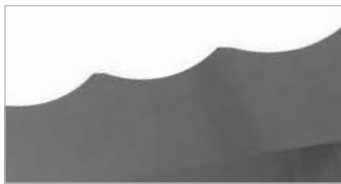

Denture large pour laine de verre  
Wide teeth for glass wool

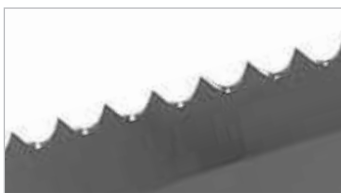

Denture fine pour polystyrène  
Fine toothting for polystyrene



- ▶ Grande longueur de lame pour couper les rouleaux jusqu'à 60 cm  
Long blade length to cut rolls up to 60 cm
- ▶ Double denture: fine pour le polystyrène, large pour la laine de verre et de roche  
Double teeth: fine for polystyrene, wide for glass and rock wool
- ▶ Couper sans effort et de façon nette et précise  
Quick and perfect cutting lines
- ▶ Poignée rubber confortable  
Comfortable rubber handle



RUBBER  
Grip

Couteau à matériaux isolants - Knife for insulating materials

Gencode **3431542120371**

Longueur de lame - Blade length

**280 mm**

Données logistiques - Logistic informations



3 431542 120371

Box 230x50x20 mm | Master 100 x 0,11 kg | Pal 230 pcs | Ctr 20ft 71000 pcs

## Porte de protection - Protection door

220x 112 cm

- ▶ Porte 68 x 192 cm  
Door 68 x 192 cm

**Isoler rapidement une pièce**  
Quick & easy room isolation

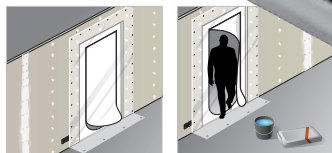

Gencode **3431542120128**

Données logistiques - Logistic informations



Box 126x60x24 mm | Master 48 x 0,25 kg  
Pal 576 | Ctr 20ft 14957 pcs

## Protection adhésive - Adhesive protection

Sols durs - Hard floors

- ▶ Protège les surfaces vitrées  
Protects glazed surfaces
- ▶ Repositionnable, nettoyage facile  
Repositionnable, usable for cleaning

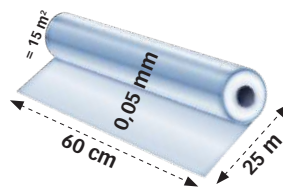

Gencode **3431542120302**

Données logistiques - Logistic informations



Box 270x35x140 mm | Master 24 x 0,25 kg  
Pal 432 | Ctr 20ft 22705 pcs

## Pince pour rail - Rail plier

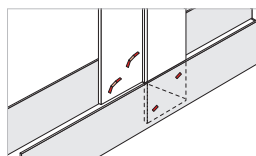
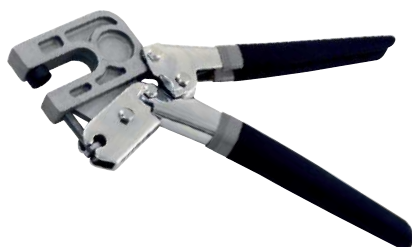

Gencode **3431542120029**

Données logistiques - Logistic informations



Box 330x35x140 mm | Master 24 x 0,62 kg  
Pal 576 | Ctr 20ft 13800 pcs

## Cisaille à tôle - Steel sheet shear

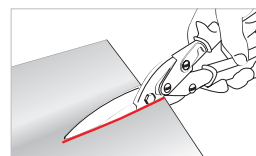

Gencode **3431541505070**

Données logistiques - Logistic informations



Box 305x30x80 mm | Master 36 x 0,37 kg  
Pal 972 | Ctr 20ft 27500 pcs

DÉCAPAGE  
STRIPPING

ÉLECTROPORTATIF  
HANDPOWER TOOLS

X-FIT  
RANGE

ATELIER  
WORKSHOP

BOIS  
WOOD MACHINES

MÉTAL  
METAL MACHINES

NETTOYAGE  
CLEANING

PLAQUISTE  
PLASTERBOARDER

JARDIN FILAIRE  
GARDEN TOOLS

Plus d'info sur  
**fartools.com**

## Grignoteuse - Rail nibbler

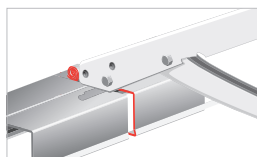

Gencode **3431542120043**

Données logistiques - Logistic informations



Box 320x40x120 mm | Master 24 x 0,45 kg  
Pal 720 | Ctr 20ft 27600 pcs

## Foret conique étagé - Staged conical drill

HSS 42-41 - ø 4 - 32 mm

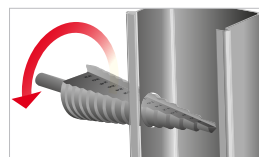

Gencode **3431542120166**

Données logistiques - Logistic informations



Box 120x39x40 mm | Master 50 x 0,19 kg  
Pal 1200 | Ctr 20ft 109700 pcs

## Kit rail du plaquiste - Plaquist kit



Idéal cross-selling



Gencode **3431542120111**

Données logistiques - Logistic informations



Box 410x70x285 mm | Master 8 x 2,15 kg  
Pal 128 | Ctr 20ft 3576 pcs

## 10 embouts de vissage à butée intégrée

10 Screw bits

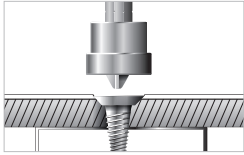

Gencode **3431542120159**

Données logistiques - Logistic informations



Box 150x20x60 mm | Master 100 x 0,15 kg  
Pal 3000 | Ctr 20ft 14238 pcs

## Pince à cheville métal - Metal peg plier

4 a 8 mm

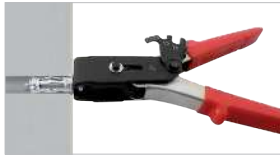

Gencode **3431542120265**

Données logistiques - Logistic informations



Box 48x130x35 mm | Master 24 x 0,40 kg  
Pal 384 | Ctr 20ft 13200 pcs

## Règle multifonction - Multifunction ruler

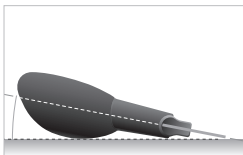
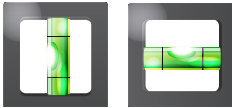

Gencode **3431542120210**

Données logistiques - Logistic informations



Box 110x30x60 mm | Master 36 x 0,30 kg  
Pal 540 | Ctr 20ft 18000 pcs

## Etrier lève-plaque - Plasterboard rise device

68 kg maxi

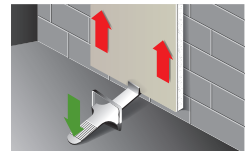
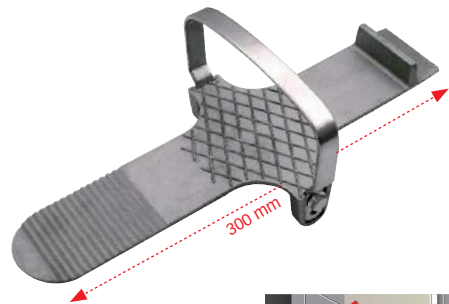

Gencode **3431542120074**

Données logistiques - Logistic informations



Box 375x55x140 mm | Master 12 x 0,65 kg  
Pal 360 | Ctr 20ft 9120 pcs

DÉCAPAGE  
STRIPPING

ÉLECTROPORATIF  
HANDPOWER TOOLS

X-FIT  
RANGE

ATELIER  
WORKSHOP

BOIS  
WOOD MACHINES

MÉTAL  
METAL MACHINES

NETTOYAGE  
CLEANING

PLAQUISTE  
PLASTERBOARDER

JARDIN FILAIRE  
GARDEN TOOLS

Plus d'info sur  
**fartools.com**

## Poignée transport de plaque

Plasterboard transportation handle

- ▶ Poids maximum 30 kg  
Maximum weight 30 kg



Gencode **3431542120098**

Données logistiques - Logistic informations



Box 430x70x165 mm | Master 12 x 0,4 kg  
Pal 288 | Ctr 20ft 6852 pcs

## Porte plaque à griffes - Claw plate holder

- ▶ Poids maximum 30 kg  
Maximum weight 30 kg
- ▶ Plâtre et OSB  
Plaster board & OSB



Gencode **3431542120333**

Données logistiques - Logistic informations



Box 245x70x195 mm | Master 12 x 1,5 kg  
Pal 252 | Ctr 20ft 7000 pcs

## Etai de plaquiste - Plasterboard prop

- ▶ Poids maximum 60 kg  
Maximum weight 60 kg

**NOUVEAU**



160 - 290 cm



Gencode **3431542120081**

Données logistiques - Logistic informations



Box 80x45x156 mm | Master 4 x 1,9 kg  
Pal 48 | Ctr 20ft 4330 pcs



# Lève-plaque - Drywall panel hoist - LV 3350

1120 - 3350 mm

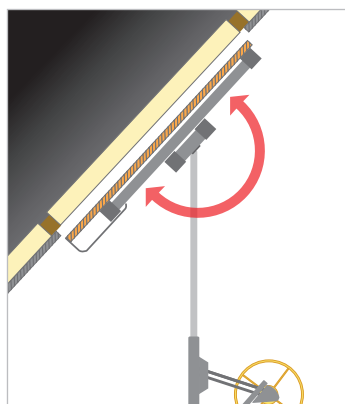
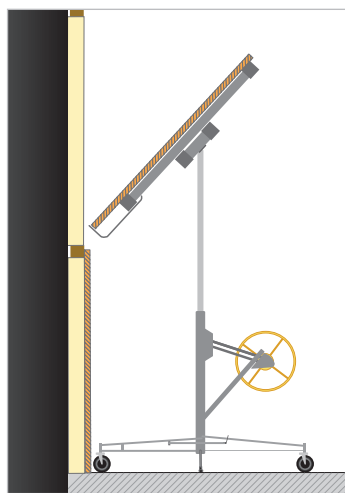

1120 - 3350 mm

- ▶ Charge maxi 68 kg  
68 kg maximum load
- ▶ Frein anti recul  
Hold brake
- ▶ Hauteur 1,12 à 3,35 mètres maximum  
1,12 to 3,35 meters height maxi
- ▶ Inclinable à 45°  
45° tilting

YouTube



Lève plaque - Drywall panel hoist	LV 3350
Gencode	3431542120104
Charge maxi - Maximum load	65 kg
Hauteur - Height	1,12 - 3,35 m
Inclinaison - Tilting	45°

Données logistiques - Logistic informations



3 431542 120104

Box 1320x560x190 mm | Master 1 x 68,5 kg  
Pal 7 | Ctr 20ft 200 pcs

DÉCAPAGE  
STRIPPING

ÉLECTROPORTATIF  
HANDPOWER TOOLS

X-FIT  
RANGE

ATELIER  
WORKSHOP

BOIS  
WOOD MACHINES

MÉTAL  
METAL MACHINES

NETTOYAGE  
CLEANING

PLAQUISTE  
PLASTERBOARDER

JARDIN FILAIRE  
GARDEN TOOLS

Plus d'info sur  
**far**tools.com



## Robot à chanfreiner - Chamfering planer

- ▶ 4 réglages de profondeur 9,5/12,5/15 et >15mm  
4 depth adjustments 9,5/12,5/15 and up to 15 mm
- ▶ Lame frontale réversible  
Reversible front blade



Gencode **3431542120357**

Données logistiques - Logistic informations



Box 126x60x24 mm | Master 48 x 0,25 kg  
Pal 576 | Ctr 20ft 14957 pcs

Consommables - Consumables

Lames 5+5 pcs- Blades **3431542120364**



## Mini robot à plâtre - Mini planer for plaster

- ▶ Grille 135x35 mm  
135x35 mm Grid

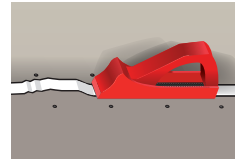

Gencode **3431542120067**

Données logistiques - Logistic informations



Box 215x75x65 mm | Master 40 x 0,1 kg  
Pal 960 | Ctr 20ft 25120 pcs

## Scie à main - Hand saw

- ▶ Multi-positions  
Multiposition
- ▶ 3 Lames incluses  
3 Including blades
- ▶ Changement rapide de lame  
Quick blade replacement



Gencode **3431542120326**

Données logistiques - Logistic informations



Box 270x35x140 mm | Master 24 x 0,25 kg  
Pal 432 | Ctr 20ft 22705 pcs

## Scie plaque de plâtre - Drywall panel saw

- ▶ Lame 160 mm  
160 mm blade
- ▶ Pointe aiguisée  
Sharp head



YouTube

**NOUVEAU**



Gencode **3431542120012**

Données logistiques - Logistic informations



Box 370x30x65 mm | Master 30 x 0,15 kg  
Pal 1470 | Ctr 20ft 29730 pcs

## Cutter circulaire de plaquiste

Plasterboard circular cutter

- ▶ Diamètre de coupe maximum 400 mm  
Maximum cutting diameter 400 mm

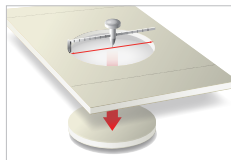

Gencode **3431542120142**

Données logistiques - Logistic informations



Box 290x40x65 mm | Master 48 x 0,25 kg  
Pal 576 | Ctr 20ft 26665 pcs

## Set de 4 couteaux à enduire

Set of 4 knives



Gencode **3431542120173**

Données logistiques - Logistic informations



Box 300x25x65 mm | Master 60 x 0,51 kg  
Pal 1200 | Ctr 20ft 37800 pcs

## Spatule à enduire INOX - INOX Spatula

150 mm

- ▶ Avec embout de vissage  
With screwing bit

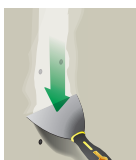

Gencode **3431542120180**

Données logistiques - Logistic informations



Box 300x25x65 mm | Master 60 x 0,51 kg  
Pal 1200 | Ctr 20ft 37800 pcs

## Spatule à enduire INOX - INOX Spatula

300 mm



Gencode **3431542120197**

Données logistiques - Logistic informations



Box 330x35x305 mm | Master 40 x 0,30 kg  
Pal 280 | Ctr 20ft 19454 pcs

DÉCAPAGE  
STRIPPING

ÉLECTROPORATIF  
HANDPOWER TOOLS

X-FIT  
RANGE

ATELIER  
WORKSHOP

BOIS  
WOOD MACHINES

MÉTAL  
METAL MACHINES

NETTOYAGE  
CLEANING

PLAQUISTE  
PLASTERBOARDER

JARDIN FILAIRE  
GARDEN TOOLS

Plus d'infos sur  
**fartools.com**

## Dévidoir à bande - Tape feeder



Gencode **3431542120340**

Données logistiques - Logistic informations



Box 315x50x90 mm | Master 24 x 0,3 kg  
Pal 576 | Ctr 20ft 7000 pcs

## Patch de réparation - Repair patch

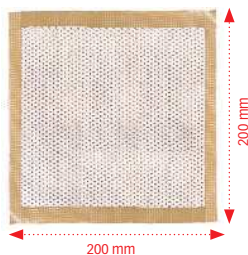

Gencode **3431542120289**

Données logistiques - Logistic informations



Box 265x20x240 mm | Master 800 x 0,02 kg  
Pal 800 | Ctr 20ft 156100 pcs

## Bac à enduit - Coating tub

250 mm - 2 L

- ▶ Avec support de spatule et sangle de préhension  
With spatula support and hand strap



Gencode **3431542120227**

Données logistiques - Logistic informations



Box 110x147x367 mm | Master 24 x 0,32 kg  
Pal 360 | Ctr 20ft 1800 pcs

## Kit à enduire - Plasterboard repair toolkit

5 pcs

Idéal cross-selling



Gencode **3431542120258**

Données logistiques - Logistic informations



Box 220x190x355 mm | Master 96 x 0,75 kg  
Pal 96 | Ctr 20ft 3183 pcs

**Présentoir de la gamme  
ENDUIT AU ROULEAU**



**NOUVEAU**

**Rouleau pour enduit**

*Roller for plaster*



**NOUVEAU**

Gencode **3431542120456**

Données logistiques - Logistic informations



Box 215x20x65 mm | Master 144 x 0,07 kg  
Pal 2592 | Ctr 20ft 307781 pcs

**Truelle d'angle intérieur INOX**

*INOX - Interior corner trowel*



**NOUVEAU**

- ▶ 75 x 110 mm - épaisseur 0,7 mm  
75 x 110 mm - thickness 0.7 mm

Gencode **3431542120463**

Données logistiques - Logistic informations



Box 320x30x140 mm | Master 72 x 0,20 kg  
Pal 576 | Ctr 20ft 18400 pcs

**Taloche - Float**

*INOX - 120 x 270 mm*

- ▶ Poignée confort  
Comfort handle



**NOUVEAU**

Gencode **3431542120470**

Données logistiques - Logistic informations



Box 290x85x140 mm | Master 50 x 0,16 kg  
Pal 300 | Ctr 20ft 17700 pcs

DÉCAPAGE  
STRIPPING

ÉLECTROPORATIF  
HANDPOWER TOOLS

X-FIT  
RANGE

ATELIER  
WORKSHOP

BOIS  
WOOD MACHINES

MÉTAL  
METAL MACHINES

NETTOYAGE  
CLEANING

PLAQUISTE  
PLASTERBOARDER

JARDIN FILAIRE  
GARDEN TOOLS

Plus d'info sur  
**fartools.com**

## Spatule à lisser - Smoothing spatula

INOX - 250 mm - 0,3 mm

## Spatule à lisser - Smoothing spatula

INOX - 450 mm - 0,3 mm

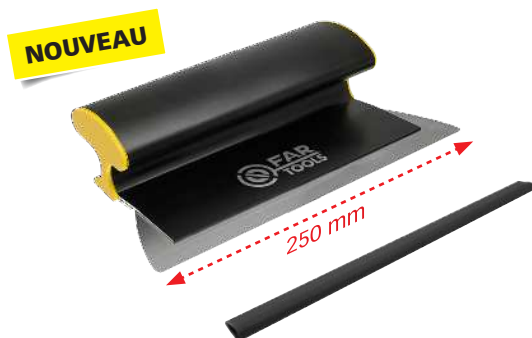

- ▶ Profilé ALU à rigidité accrue  
ALU profile with increased rigidity
- ▶ Réglette de protection plastique  
Plastic guard

Gencode **3431542120418**

Données logistiques - Logistic informations



Box 315x50x90 mm | Master 24 x 0,3 kg  
Pal 576 | Ctr 20ft 7000 pcs



- ▶ Profilé ALU à rigidité accrue  
ALU profile with increased rigidity
- ▶ Réglette de protection plastique  
Plastic guard

Gencode **3431542120425**

Données logistiques - Logistic informations



Box 265x20x240 mm | Master 800 x 0,02 kg  
Pal 800 | Ctr 20ft 156100 pcs

## Spatule à lisser - Smoothing spatula

INOX - 650 mm - 0,3 mm

## Perche pour spatule à lisser

Smoothing spatula pole



- ▶ Profilé ALU à rigidité accrue  
ALU profile with increased rigidity
- ▶ Réglette de protection plastique  
Plastic guard

Gencode **3431542120432**

Données logistiques - Logistic informations



Box 110x147x367 mm | Master 24 x 0,32 kg  
Pal 360 | Ctr 20ft 1800 pcs



- ▶ Télescopique de 1 m à 1,80 m  
Telescopic from 1 m to 1,80 m

Gencode **3431542120449**

Données logistiques - Logistic informations



Box 220x190x355 mm | Master 96 x 0,75 kg  
Pal 96 | Ctr 20ft 3183 pcs

## Grattoir plat avec protégé lame

*Flat scrapper*

- ▶ 1 Lame réversible : 2 cotés tranchants  
1 reversible blade : 2 sharp sides

**NOUVEAU**



Gencode **3431542120203**

Données logistiques - Logistic informations



Box 215x20x65 mm | Master 144 x 0,07 kg  
Pal 2592 | Ctr 20ft 307781 pcs

## Grattoir plat - Flat scrapper

100 mm

- ▶ 1 Lame réversible : 1 coté décollage précis, 1 coté racleage  
1 Reversible blade: 1 side for precise removal, 1 for scraping

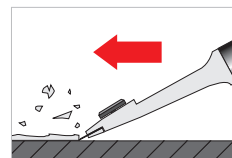

Gencode **3431542120005**

Données logistiques - Logistic informations



Box 320x30x140 mm | Master 72 x 0,20 kg  
Pal 576 | Ctr 20ft 18400 pcs

Consommables - Consumables

Lames - Blades

**3431542120050**

## Plateau de ponçage manuel

*Manual sanding pad - 225 x 85 mm*

- ▶ Poignée confort  
Comfort handle



Gencode **3431542120241**

Données logistiques - Logistic informations



Box 290x85x140 mm | Master 50 x 0,16 kg  
Pal 300 | Ctr 20ft 17700 pcs

DÉCAPAGE  
STRIPPING

ÉLECTROPORATIF  
HANDPOWER TOOLS

X-FIT  
RANGE

ATELIER  
WORKSHOP

BOIS  
WOOD MACHINES

MÉTAL  
METAL MACHINES

NETTOYAGE  
CLEANING

PLAQUISTE  
PLASTERBOARDER

JARDIN FILAIRE  
GARDEN TOOLS

Plus d'info sur  
**far.tools.com**

# L'univers du Carreleur

Tiler's range

PROTÉGER - ENCOLLER - DÉCOUPER - POSER - RÉNOVER - NETTOYER

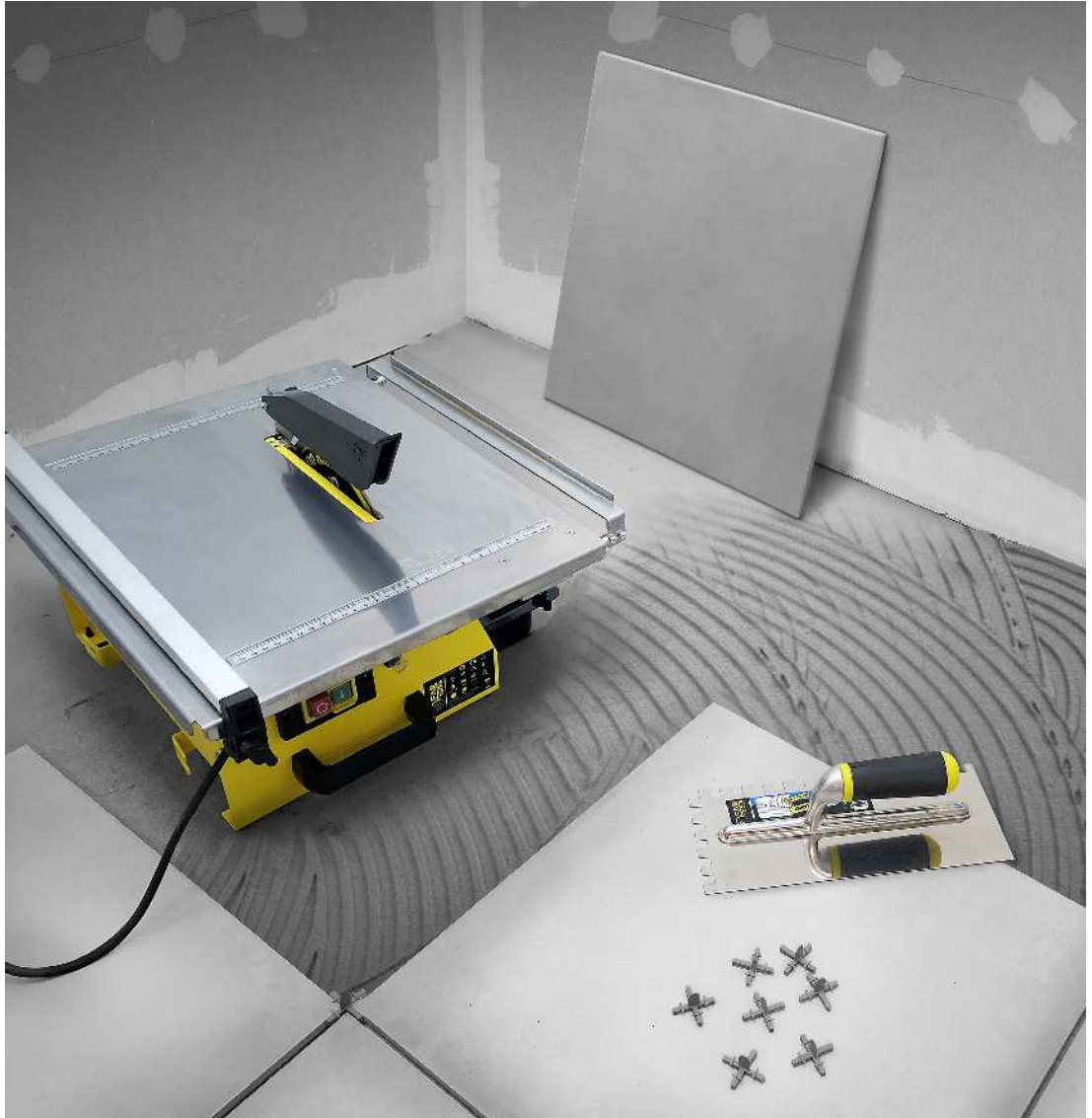

DÉCAPAGE  
STRIPPING

ELECTROPORTATIF  
HANDPOWER TOOLS

X-FIT  
RANGE

ATELIER  
WORKSHOP

BOIS  
WOOD MACHINES

MÉTAL  
METAL MACHINES

NETTOYAGE  
CLEANING

CARRELEUR  
TILE LAYER

JARDIN FILAIRE  
GARDEN TOOLS

Plus d'info sur  
**fartools.com**

# Offre complète de 1 à 2 mètres linéaires

Complete offer from 1 to 2 meters linear

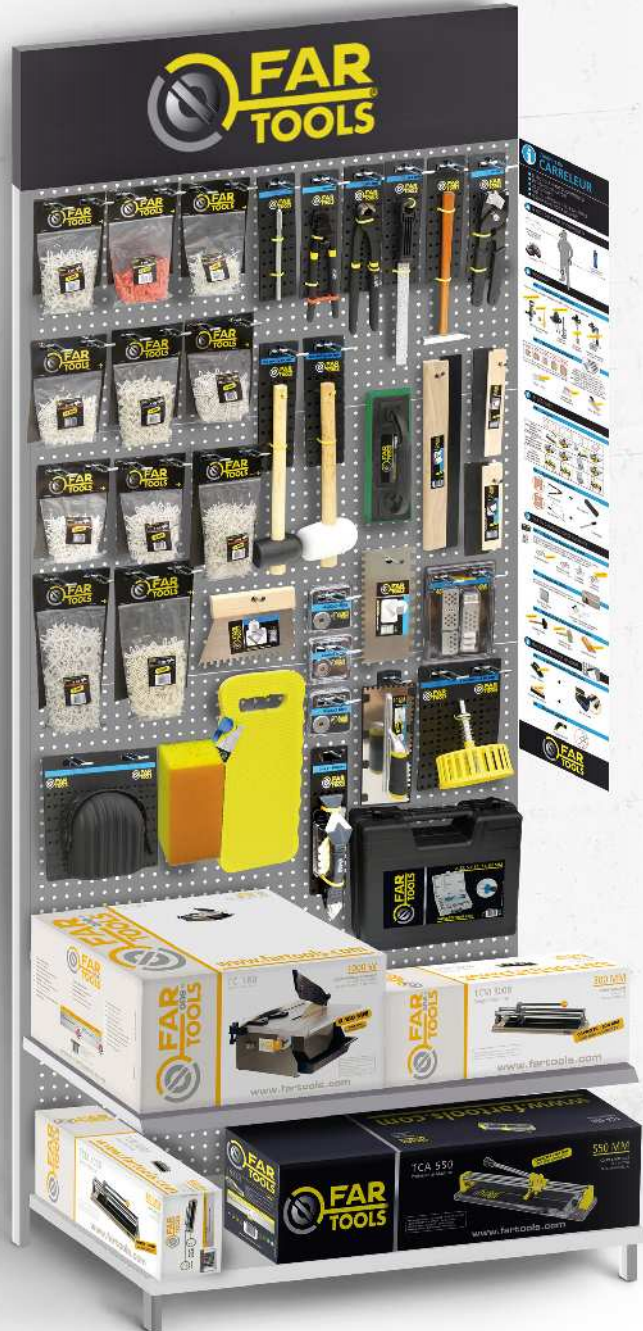



# Coupe carrelage manuel - Manual tile cutter - TCA 550

550 mm



► **Coupe rectiligne rapide**  
Quick straight cut

- Diamètre des barres : 20 mm  
Tube diameter: 20 mm
- Guidage roulement à billes  
Ball bearing guidance
- Guide d'angle  
Angle guide

*Livré avec guide d'angle et molette carbure montée*  
Delivered with angle guide and carbide wheel mounted

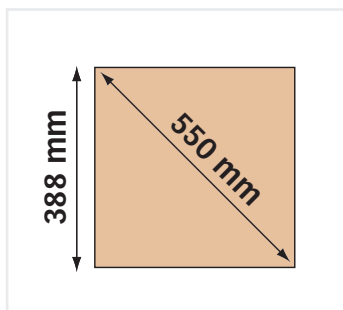

**GRADUÉ**



**ANGLE**  
Guide



**BALL**  
Bearing

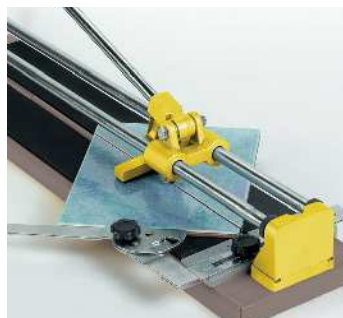

Coupe carrelage manuel - Manual tile cutter		TCA 550
	Gencode	<b>3431542102155</b>
Longueur de coupe maxi- max cutting Length		<b>550 mm</b>
Dimension de la molette - Carbide wheel size		<b>22x6x2 mm</b>
Épaisseur de coupe maximum- Maximum cutting thickness		<b>16 mm</b>
Diamètre des barres - Bars diameter		<b>ø 20mm</b>
<b>Données logistiques - Logistic informations</b>		
 Box 190x140x760 mm   Master 3 x 7 kg   Pal 66 pcs   Ctr 20ft 1300 pcs		
<b>Consommables - Consumables</b>		
Molette carbure - Carbide wheel		<b>3431542108034</b>

DÉCAPAGE  
STRIPPING

ÉLECTROPORTATIF  
HANDPOWER TOOLS

X-FIT  
RANGE

ATELIER  
WORKSHOP

BOIS  
WOOD MACHINES

MÉTAL  
METAL MACHINES

NETTOYAGE  
CLEANING

CARRELEUR  
TILE LAYER

JARDIN FILAIRE  
GARDEN TOOLS

Plus d'info sur  
**fartools.com**

# Coupe carrelage manuel - Manual tile cutter - TCM 650

650 mm

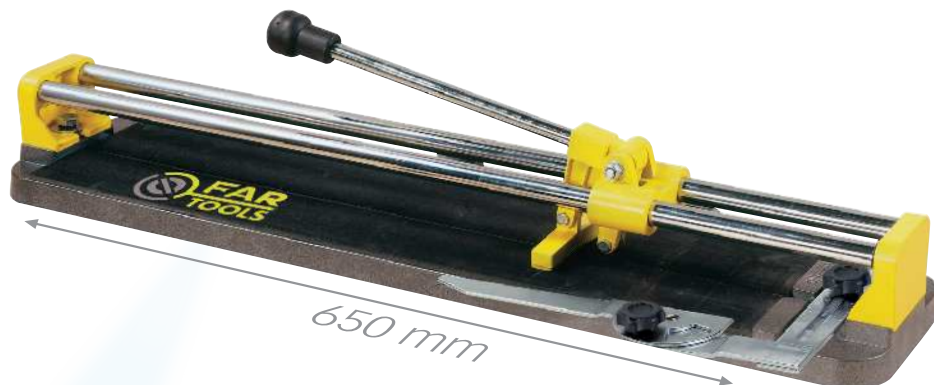

► **Coupe rectiligne rapide**  
Quick straight cut

- Diamètre des barres : 20 mm  
Tube diameter: 20 mm
- Guidage roulement à billes  
Ball bearing guidance
- Guide d'angle  
Angle guide



Livré en mallette avec guide d'angle et molette carbure montée  
Delivered in BMC with angle guide and carbide wheel mounted

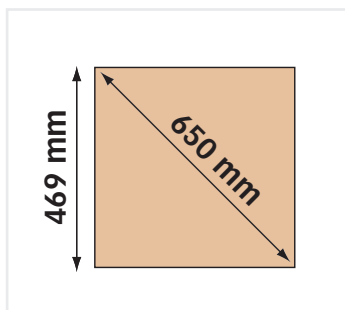

**GRADUÉ**



**ANGLE**  
Guide



**BALL**  
Bearing

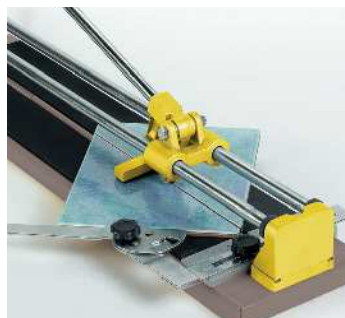

Coupe carrelage manuel - Manual tile cutter		TCM 650
	Gencode	<b>3431542102315</b>
Longueur de coupe maxi - Max cutting Length		<b>650 mm</b>
Dimension de la molette - Carbide wheel size		<b>22x6x2 mm</b>
Epaisseur de coupe maximum - Maximum cutting thickness		<b>16 mm</b>
Diamètre des barres - Bars diameter		<b>ø 20mm</b>
<b>Données logistiques - Logistic informations</b>		
 Box 870x155x270 mm   Master 1 x 8,00 kg   Pal 30 pcs   Ctr 20ft 1000 pcs 3 431542 102315		
<b>Consommables - Consumables</b>		
Molette carbure - Carbide wheel		<b>3431542108034</b>

# Coupe carrelage manuel - Manual tile cutter - J 675

675 mm

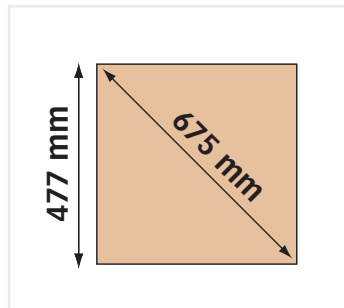

- ▶ Coupe rectiligne rapide  
Quick straight cut
- ▶ Extensions latérales  
Lateral extensions
- ▶ Guidage sur mono rail à roulement à billes  
Single rail ball bearing guidance
- ▶ Base aluminium  
Alu base



Livré en sac nylon indéchirable avec guide d'angle et molette carbure montée  
Delivered in nylon bag with angle guide and carbide wheel mounted



**GRADUÉ**



**ANGLE**  
Guide



**BALL**  
Bearing

Coupe carrelage manuel - Manual tile cutter

J 675

Gencode

**3431542106757**

Longueur de coupe maxi - Max cutting Length

**675 mm**

Dimension de la mollette - Carbide wheel size

**22x10,5x2 mm**

Épaisseur de coupe maximum - Maximum cutting thickness

**20 mm**

Données logistiques - Logistic informations



3 431542 106757

Box 930x320x200 mm | Master 2 x 11,30 kg  
| Pal 18 pcs | Ctr 20ft 1000 pcs

Consommables - Consumables

Molette carbure - Carbide wheel

**3431542108041**

DÉCAPAGE  
STRIPPING

ÉLECTROPORATIF  
HANDPOWER TOOLS

X-FIT  
RANGE

ATELIER  
WORKSHOP

BOIS  
WOOD MACHINES

MÉTAL  
METAL MACHINES

NETTOYAGE  
CLEANING

CARRELEUR  
TILE LAYER

JARDIN FILAIRE  
GARDEN TOOLS

Plus d'info sur  
**fartools.com**

# Coupe carrelage électrique - Electric Tile cutter - TC 200

200 mm  
900 Watts



- ▶ **Idéal pour coupes techniques**  
Ideal for partial cuts
- ▶ Pour fortes épaisseurs : jusqu'à 41 mm  
For high thickness: up to 41 mm
- ▶ **Protection thermique manuelle**  
Manual thermal protection
- ▶ Table inclinable à 45° pour coupes en biseau  
45° tilting Table for bevel cuts
- ▶ Extension latérale pour grands carreaux  
Lateral extension for large tiles
- ▶ Règle à fixation rapide  
Fast tightening ruler
- ▶ Poignées de transport  
Carrying handles
- ▶ Range câble  
Cable storage

Livré avec 1 disque, 1 guide parallèle, 1 guide d'angle, 1 extension  
Delivered with 1 disc, 1 parallel guide, 1 angle guide, 1 extension



**THERMAL**  
Protection



**POIGNÉE**  
Handle



**INCLINABLE**  
Tilting

Coupe carrelage électrique - Electric Tile cutter		TC 200
Gencode	3431541135154	
Puissance du moteur - Motor power (230V-50Hz)	900 W	
Table inclinable - Tilting table	0 - 45 °	
Dimensions de lame - Disc size	200x 22,2 x 2 mm	
Capacité de coupe maximum - Maximum cutting capacity	41 mm	
Dimension de table - Table size	400 x 500 mm (Mini) 560 x 500 mm (maxi)	
Données logistiques - Logistic informations		
 Box 330x350x380 mm   Master 1x17,20 kg   Pal 25 pcs   Ctr 20ft 480 pcs		
Consommables - Consumables		
CARLA'O HQ COBALT - 200x30/25,4/22,2x5x1,6 mm	3431541191402	
CARLA'O - 200x30/25,4/22,2x5, 6x2,7 mm	3431541191457	

# Coupe carrelage électrique - Electric Tile cutter - TCS 200

200 mm  
550 Watts



Table sur glissière : **sécurité et confort**  
Sliding table: **safety and comfort**



Guide de coupe d'angle à 45°  
Angle guide 45° guide

- ▶ **Table sur glissière = sécurité et confort**  
Sliding table fort safety and comfort
- ▶ **Grande capacité de coupe = idéal pour grands carreaux**  
Large cutting capacity = ideal for large tiles
- ▶ **Grande table pour une bonne stabilité**  
Large table for good stability
- ▶ **2 étaux de maintien de carreaux pour la précision**  
2 tile retaining vises for accuracy
- ▶ **Poignées ergonomiques pour le confort**  
Ergonomic handles for comfort
- ▶ **Guide de coupe d'angle à 45°**  
Angle cutting guide at 45°

Livré avec 1 disque, 1 guide parallèle, 2 étaux, 2 supports stabilisateurs  
Supplied with 1 disc, 1 parallel guide, 2 vises, 2 stabilizer brackets



**POIGNÉE**  
Handle



**INCLINABLE**  
Tilting

YouTube



Coupe carrelage électrique - Electric Tile cutter		TCS 200
Gencode	<b>3431541135147</b>	
Puissance du moteur - Motor power (230V-50Hz)	<b>550 W</b>	
Table inclinable - Tilting table	<b>0 - 45 °</b>	
Dimensions de lame - Disc size	<b>200x 22,2 x 2 mm</b>	
Capacité de coupe maximum - Maximum cutting capacity	<b>30 mm</b>	
Dimension de table - Table size	<b>485 x 435 mm RADIAL</b>	
Données logistiques - Logistic informations		
3 431541 135147   Box 580x520x260 mm   Master 1x18,00 kg   Pal 16 pcs   Ctr 20ft 312 pcs		
Consommables - Consumables		
CARLA'O HQ COBALT - 200x30/25,4/22,2x5x1,6 mm	<b>3431541191402</b>	
CARLA'O - 200x30/25,4/22,2x5, 6x2,7 mm	<b>3431541191457</b>	

DÉCAPAGE  
STRIPPING

ÉLECTROPORATIF  
HANDPOWER TOOLS

X-FIT  
RANGE

ATELIER  
WORKSHOP

BOIS  
WOOD MACHINES

MÉTAL  
METAL MACHINES

NETTOYAGE  
CLEANING

CARRELEUR  
TILE LAYER

JARDIN FILAIRE  
GARDEN TOOLS

Plus d'info sur  
**far.tools.com**

# Coupe carrelage électrique radial - Radial electric Tile cutter - TCR 720B

200 mm  
800 Watts



- ▶ **Capacité de coupe jusqu'à 740 mm**  
**Cutting capacity up to 740 mm**
- ▶ **Guidage confortable, précision de coupe**  
Comfortable guide, cutting accuracy
- ▶ **Tête inclinable à 45° pour la coupe en biseau**  
45° tilting blade for bevel cutting
- ▶ **Pompe à refroidissement à eau intégrée**  
Integrated water cooling pump
- ▶ **2 extensions latérales pour les grands carreaux**  
2 lateral extensions for large tiles
- ▶ **Prise PRCD fournie**  
PRCD plug provided
- ▶ **Laser pour visualiser le passage du disque**  
Laser to visualize the passage of the disk



Extensions latérales  
Lateral extension



Tête inclinable à 45°  
Tilting head 45°

Livré prémontée avec 1 disque diamant, 2 extensions latérales, 4 pieds amovibles  
Delivered partially mounted with 1 diamond disc, 2 side extensions, 4 removable feet



**LASER**  
Target



**INCLINABLE**  
Tilting

Coupe carrelage électrique radial - Radial electric tile cutter

TCR 720B

Gencode	<b>3431541135130</b>
Puissance du moteur - Motor power (230V-50Hz)	<b>800 W</b>
Dimensions de lame - Disc size	<b>200x 22,2 x 2 mm</b>
Capacité de coupe maximum Maximum cutting capacity	<b>36 mm x740 mm</b>
Dimension de table Table size	<b>485 x 435 mm + 200 x 225 mm (x2)</b>

Données logistiques - Logistic informations

3 431541135130 Box 1125x430x390 mm | Master 1x35,8 kg | Pal 8 pcs | Ctr 20ft 158 pcs

Consommables - Consumables

CARLA'O HQ COBALT - 200x30/25,4/22,2x5x1,6 mm	<b>3431541191402</b>
CARLA'O - 200x30/25,4/22,2x5, 6x2,7 mm	<b>3431541191457</b>

# Coupe carrelage électrique radial - Radial electric Tile cutter - TCR 230L

230 mm  
1200 Watts



- ▶ Grande capacité de coupe : **865 mm, pour matériaux durs** (dallage pierre, margelle, pavés, carrelage forte épaisseur) et grands carreaux  
Large cutting capacity: 865 mm, for hard materials (stone paving, curbstone, pavements, thick tiles) and large tiles
- ▶ **2 roulettes de transport** = idéal pour chantier  
2 transport wheels = ideal for construction site
- ▶ **Tête inclinable à 45°** pour la coupe en biseau et tête plongeante  
45° tilt head for bevel cutting and plunging head
- ▶ **Pompe à refroidissement à eau intégrée**  
Integrated water cooling pump
- ▶ **2 extensions latérales** pour les grands carreaux  
2 lateral extensions for large tiles
- ▶ **Prise PRCD fournie**  
PRCD plug provided
- ▶ **Laser pour visualiser le passage du disque**  
Laser to visualize the passage of the disk
- ▶ **Pliable + roulettes de transport**  
Foldable + transport wheels

Livré prémontée avec 1 disque diamant, 2 extensions latérales  
Delivered partially mounted with 1 diamond disc, 2 side extensions

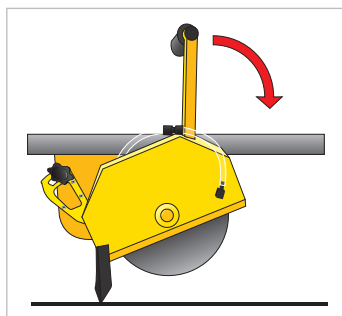

Fonction tête plongeante  
Plunging blade



Tête inclinable à 45°  
Tilting head 45°



**LASER**  
Target



**INCLINABLE**  
Tilting

Coupe carrelage électrique radial - Radial electric tile cutter		TCR 230L
Gencode	3431541136113	
Puissance du moteur - Motor power (230V-50Hz)	1200 W	
Dimensions de lame - Disc size	230 x 25,4 x 2 mm	
Capacité de coupe maximum Maximum cutting capacity	42 mm x 865 mm	
Dimension de table Table size	485 x 435 mm + 200 x 225 mm (x2)	
Données logistiques - Logistic informations		
3 431541 136113 Box 1450x520x550 mm   Master 1x44,00 kg   Pal 2 pcs   Ctr 20ft 70 pcs		
Consommables - Consumables		
CARLA'O HQ QBALB - 230x30/25,4/22,2x5x1,6 mm	3431541191358	

DÉCAPAGE  
STRIPPING

ÉLECTROPORATIF  
HANDPOWER TOOLS

X-FIT  
RANGE

ATELIER  
WORKSHOP

BOIS  
WOOD MACHINES

MÉTAL  
METAL MACHINES

NETTOYAGE  
CLEANING

CARRELEUR  
TILE LAYER

JARDIN FILAIRE  
GARDEN TOOLS

Plus d'info sur  
**fartools.com**

**NOUVEAU**



Idéal pour sécher de grandes surfaces  
Ideal for drying large surfaces



Clipsable en série  
Serial clip on

- ▶ **3 Inclinaisons de travail différentes : Plafonds, murs et raz des sols**  
**3 different working inclinations : ceiling, walls and floors**
- ▶ **3 Vitesses de travail**  
3 working speeds
- ▶ Branchement jusqu'à 11 ventilateurs en série - 1650 W maxi  
Connection of up to 11 fans in series - 1650 W max
- ▶ Emplacement pour enroulement du câble  
Location for cable winding
- ▶ Poignée de transport  
Transportation handle
- ▶ 4 mètres de câble et léger: facile à déplacer sur vos chantiers  
4 meters of cable and lightweight: easy to move around your construction sites



Souffleur de sol et murs - Floor and wall blower	<b>SAS 150</b>
Gencode	<b>3431541153455</b>
Puissance du moteur - Motor power (230V-50Hz)	<b>150 W</b>
Vitesses de soufflerie - blowing speed	<b>523 m<sup>3</sup>/h 648 m<sup>3</sup>/h 713 m<sup>3</sup>/h</b>
Capacité de branchement maximum (nombre de machines + puissance) Maximum connection capacity (number of machines + power)	<b>x 11 1650 W</b>
Inclinaisons du ventilateur Fan Tilts	<b>0° - 45° - 90°</b>
Données logistiques - Logistic informations	



3 431541 1153455

Box 1125x430x390 mm | Master 1x35,8 kg | Pal 8 pcs | Ctr 20ft 158 pcs



## Disques diamant - Diamond discs

CARLA'O HQ & HQ COBALT

- ▶ Coupe délicate à eau pour coupe carrelage. Addition de cobalt pour une vitesse et une qualité de coupe accrues..  
Wet delicate cut for tile cutters. Cobalt addition for an improved cutting speed and quality.



Pour / feets on :  
113500 / 113540



180 x 22.2 x 5 x 1.6 mm

3431541190580



Pour / feets on :  
113513 / 113507



200 x 22.2 x 5 x 1.6 mm

3431541191402



Pour / feets on :  
113611



230 x 22.2 x 5 x 1.6 mm

3431541191358



## Disques diamant - Diamond discs

CARLA'O

- ▶ Coupe délicate à eau pour coupe carrelage..  
Wet delicate cut for tile cutters.



Pour / feets on :  
113500 / 113540



180 x 22.2 x 5,4 x 2,4 mm

3431541191501



Pour / feets on :  
113513 / 113507



200 x 22.2 x 5,6 x 2,7 mm

3431541191457



## Porte de protection - Protection door

220 x 112 cm

- ▶ Porte 68 x 192 cm  
Door 68 x 192 cm

Isoler rapidement une pièce  
Quick & easy room isolation

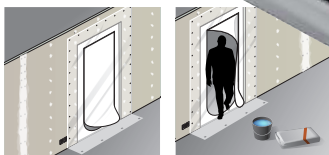

Gencode **3431542120128**

Données logistiques - Logistic informations



Box 126x60x24 mm | Master 48 x 0,25 kg  
Pal 576 | Ctr 20ft 14957 pcs

## Protection adhésive - Adhesive protection

Sols durs - Hard floors

- ▶ Protège les surfaces vitrées  
Protects glazed surfaces
- ▶ Repositionnable, nettoyage facile  
Repositionable, usable for cleaning

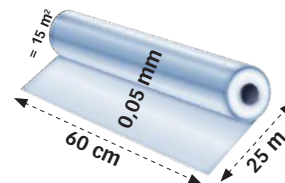

Gencode **3431542120302**

Données logistiques - Logistic informations



Box 270x35x140 mm | Master 24 x 0,25 kg  
Pal 432 | Ctr 20ft 22705 pcs

DÉCAPAGE  
STRIPPING

ÉLECTROPORTEATIF  
HANDPOWER TOOLS

X-FIT  
RANGE

ATELIER  
WORKSHOP

BOIS  
WOOD MACHINES

MÉTAL  
METAL MACHINES

NETTOYAGE  
CLEANING

CARRELEUR  
TILE LAYER

JARDIN FILAIRE  
GARDEN TOOLS

Plus d'info sur  
**fartools.com**

## Tapis de pose en mousse - Work board

- Pour la pose de carrelage  
For Tiling



Gencode **3431541165359**

Données logistiques - Logistic informations



Box 400x20x180 mm | Master 50 x 0,10 kg  
Pal 900 | Ctr 20ft 16850 pcs

## Genouillères techniques - Kneepads

- La paire en mousse avec sangle de réglage  
The pair in foam with adjustable straps



Gencode **3431541165014**

Données logistiques - Logistic informations



Box 215x130x215 mm | Master 24 x 0,25 kg  
Pal 216 | Ctr 20ft 7300 pcs

## Genouillères techniques - Kneepads

- Souples et légères, confortables  
Light and flexible, comfortable



Gencode **3431541165229**

Données logistiques - Logistic informations



Box 235x130x180 mm | Master 12 x 0,40 kg  
Pal 216 | Ctr 20ft 10200 pcs

## Genouillères techniques - Kneepads

- Soft Gel, stabilité du genou, confortable  
Soft Gel, Stability and comfortable



Gencode **3431541165212**

Données logistiques - Logistic informations



Box 260x130x190 mm | Master 12 x 0,50 kg  
Pal 216 | Ctr 20ft 4500 pcs

## Pointe à tracer - Scriber



Gencode **3431541165274**

Données logistiques - Logistic informations



Box 215x20x65 mm | Master 100 x 0,14 kg  
Pal 1800 | Ctr 20ft 115000 pcs

## Mèche à percer les carreaux - Drilling tiles

ø 20 à 90 mm

- Carbure de tungstène, panier plastique  
Tungsten carbide, with plastic basket



**NOUVEAU**

Gencode **3431541165267**

Données logistiques - Logistic informations



Box 215x110x140 mm | Master 36 x 0,40 kg  
Pal 216 | Ctr 20ft 9200 pcs

## Tenaille de carreleur - Tiler tongs

200 mm

- Mâchoires acier trempé, finition bi-matière  
Quenched steel Jaws, soft finishing



Gencode **3431541165168**

Données logistiques - Logistic informations



Box 265x30x65 mm | Master 50 x 0,40 kg  
Pal NC | Ctr 20ft 57500 pcs

DÉCAPAGE  
STRIPPING

ÉLECTROPORATIF  
HANDPOWER TOOLS

X-FIT  
RANGE

ATELIER  
WORKSHOP

BOIS  
WOOD MACHINES

MÉTAL  
METAL MACHINES

NETTOYAGE  
CLEANING

CARRELEUR  
TILE LAYER

JARDIN FILAIRE  
GARDEN TOOLS

Plus d'info sur  
**fartools.com**

## Pince de céramiste - Ceramicist pliers

225 mm

- Mâchoires acier trempé, finition bi-matière  
Quenched steel Jaws, soft finishing



Gencode **3431541165151**

Données logistiques - Logistic informations



Box 285x25x65 mm | Master 50 x 0,35 kg  
Pal 1200 | Ctr 20ft 57500 pcs

## Pince perroquet - Parrot pliers

200 mm

- Pour grignoter les carrelages, finition bi-matière  
Enabling tiles to be nibbled out, soft finishing



Gencode **3431541165328**

Données logistiques - Logistic informations



Box 250x10x65 mm | Master 24 x 0,25 kg  
Pal 768 | Ctr 20ft 57500 pcs

## Pince coupe carreaux - Tile cutter pliers

215 mm - ø 13 mm

- Molette carbure de tungstène, ø13 mm, réglelet gradué,  
finition bi-matière  
Wheel in tungsten carbide, ruler



Gencode **3431541165311**

Données logistiques - Logistic informations



Box 260x40x65 mm | Master 50 x 0,25 kg  
Pal 1500 | Ctr 20ft 57500 pcs

## Copieur de contours - Copying device

125 mm

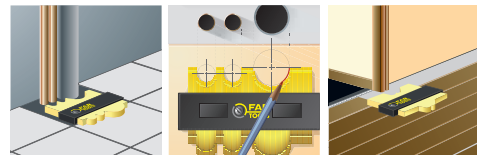

Gencode **3431541165243**

Données logistiques - Logistic informations



Box 215x25x140 mm | Master 32 x 0,30 kg  
Pal 768 | Ctr 20ft 35000 pcs

## Lime abrasive - Abrasive file

260 mm

- Carbone de tungstène, face demi-ronde/plate  
Tungsten carbide, half-round/ flat sides



Gencode **3431541165175**

Données logistiques - Logistic informations



Box 320x25x65 mm | Master 50 x 0,20 kg  
Pal NC | Ctr 20ft 54900 pcs

## Scie vilebrequin - Brace and bit saw

300 mm

- Lame ronde carbure de tungstène, poignée tournante  
Round blade in Tungsten carbide, turning handle

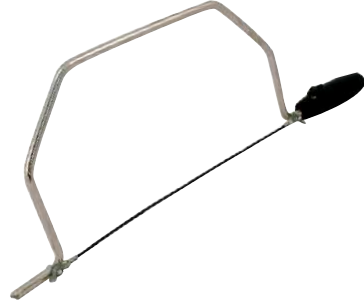

Gencode **3431541165281**

Données logistiques - Logistic informations



Box 545x45x180 mm | Master 24 x 0,35 kg  
Pal 336 | Ctr 20ft 20300 pcs

## Lame plate - Flat blade

300 mm

- Au carbure de tungstène, pour scie vilebrequin  
et scies à métaux standard  
Tungsten carbide, for brace and bit saw and mountings  
for saws

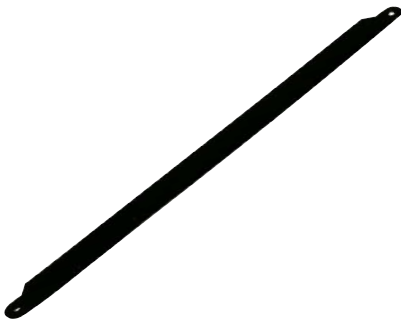

Gencode **3431541165304**

Données logistiques - Logistic informations



Box 250x10x65 mm | Master 24 x 0,25 kg  
Pal 768 | Ctr 20ft 57500 pcs

## Pierre à gréser - Abrasive stone

Gr 40/80 - 200 x 25 x 50 mm

**NOUVEAU**



Gencode **3431542110518**

Données logistiques - Logistic informations



Box 545x45x180 mm | Master 24 x 0,35 kg  
Pal 336 | Ctr 20ft 20300 pcs

DÉCAPAGE  
STRIPPING

ÉLECTROPORANTIF  
HANDPOWER TOOLS

X-FIT  
RANGE

ATELIER  
WORKSHOP

BOIS  
WOOD MACHINES

MÉTAL  
METAL MACHINES

NETTOYAGE  
CLEANING

CARRELEUR  
TILE LAYER

JARDIN FILAIRE  
GARDEN TOOLS

Plus d'infos sur  
**fartools.com**

## Malaxeur 2 spirales - 2 spirals mixer

400 mm - ø 80 mm

- ▶ Malaxage rapide = gain de temps  
Quick mixing = time saver



Gencode **3431541165052**

Données logistiques - Logistic informations

Box 320x25x65 mm | Master 50 x 0,20 kg  
Pal N.C. | Ctr 20ft 8000 pcs



3 431541 165052

## Malaxeur 1 spirale - 1 spiral mixer

200 mm - ø 80/100 mm



200 mm - ø 80 mm

**3431541165038**



3 431541 165038

200 mm - ø 100 mm

**3431541165045**



3 431541 165045

## Platoir INOX - Stainless plaster

- ▶ Dentures carrées  
Square teeth



280x120 mm - 6 mm

**3431541165410**



3 431541 165410

280x120 mm - 10 mm

**3431541165427**



3 431541 165427

## Platoir INOX - Stainless plaster

- ▶ Lisse  
Smooth



Gencode **3431541165403**

Données logistiques - Logistic informations

Box 140x80x350 mm | Master 24 x 0,45 kg  
Pal 432 | Ctr 20ft 13800 pcs



3 431541 165403

## Couteau à colle - Glue knife

INOX

- ▶ Denture carrée, monture bois, INOX  
Square teeth, wooden frame, Stainless steel



185 mm - 4 mm

3431541139121



3 431541 139121

185 mm - 5 mm

3431541139145



3 431541 139145

185 mm - 8 mm

3431541139169



3 431541 139169

## Couteau à colle - Glue knife

- ▶ Denture carrée, monture bois  
Square teeth, wooden frame



185 mm - 4 mm

3431541139046



3 431541 139046

185 mm - 6 mm

3431541139060



3 431541 139060

185 mm - 8 mm

3431541139084



3 431541 139084

## Peigne à colle - Glue comb

195 x 100 mm

- ▶ Dentures carrées 5 / 9 mm  
Square teeth 5 / 9 mm



Gencode **3431541139206**

Données logistiques - Logistic informations



3 431541 139206

Box 250x10x65 mm | Master 24 x 0,25 kg  
Pal 768 | Ctr 20ft 57500 pcs

DÉCAPAGE  
STRIPPING

ÉLECTROPORTATIF  
HANDPOWER TOOLS

X-FIT  
RANGE

ATELIER  
WORKSHOP

BOIS  
WOOD MACHINES

MÉTAL  
METAL MACHINES

NETTOYAGE  
CLEANING

CARRELEUR  
TILE LAYER

JARDIN FILAIRE  
GARDEN TOOLS

Plus d'info sur  
**far.tools.com**

## Maillet de pose - Laying mallet

300 mm - ø 60 mm

- Caoutchouc blanc, manche bois, agrippant : ne marque pas  
White rubber, wooden handle



Gencode **3431541165199**

Données logistiques - Logistic informations



Box 105x60x390 mm | Master 24 x 0,50 kg  
Pal 432 | Ctr 20ft 17500 pcs

3 4 3 1 5 4 1 1 6 5 1 9 9

## Maillet de pose - Laying mallet

280 mm - ø 50 mm

- Caoutchouc noir, manche bois, version éco  
Black rubber, wooden handle



Gencode **3431541165182**

Données logistiques - Logistic informations



Box 105x60x390 mm | Master 48 x 0,47 kg  
Pal 432 | Ctr 20ft 23800 pcs

3 4 3 1 5 4 1 1 6 5 1 8 2

## Batte de carreleur - Tiler bat

300 x 120 mm

- Bois de hêtre, semelle caoutchouc  
Beechwood, rubber pad



Gencode **3431541165076**

Données logistiques - Logistic informations



Box 380x120x50 mm | Master 24 x 1,0 kg  
Pal 288 | Ctr 20ft 8000 pcs

3 4 3 1 5 4 1 1 6 5 0 7 6

## Ventouse de préhension - Suction grip

11,5 cm - 50 kg



Gencode **3431542116329**

Données logistiques - Logistic informations



Box 110x140x215 mm | Master 24 x 0,37 kg  
Pal 432 | Ctr 20ft 18400 pcs

3 4 3 1 5 4 2 1 1 6 3 2 9



## Gamme de croisillons - Tiles spacers range

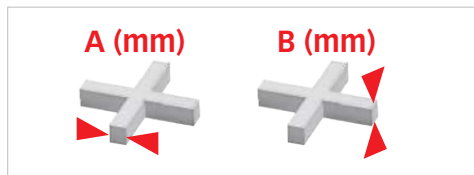

- ① Cavalier carton pour brochage linéaire  
Holed cardboard for a standard displaying
- ② Tableau indiquant la consommation au mètre carré  
Table which consumption by square meter indication
- ③ Sac refermable pour un meilleur confort de travail  
Closable Bag for a better working comfort

## Croisillons pleins - Tile spacers



A (mm) B (mm)

3431541138827	1	2	250 pcs
3431541138834	1,5	2	250 pcs
3431541138841	2	2	250 pcs
3431541138858	2	2	500 pcs
3431541161023	2	2	1000 pcs
3431541138476	2,5	2,5	250 pcs
3431541138865	3	2,5	250 pcs
3431541138780	3	2,5	500 pcs
3431541161030	3	2.5	1000 pcs

## Croisillons vides - Empty tile spacers



A (mm) B (mm)

3431541138674	4	3	200 pcs
3431541161047	4	3	500 pcs
3431541161061	5	3	500 pcs
3431541138681	5	3	200 pcs
3431541138698	6	3	100 pcs
3431541138711	8	3	100 pcs
3431541138735	10	3	100 pcs

## Croisillons réutilisables - Reusable spacers



A (mm) B (mm)

3431541138650	2	3	100 pcs
3431541138612	3	3	100 pcs
3431541138599	4	3	100 pcs

## Croisillons réutilisables - Reusable spacers



A (mm) B (mm)

3431541138544	3	5	100 pcs
3431541138537	4	5	100 pcs
3431541138520	5	5	100 pcs

## Cales d'épaisseur - Tile wedges



A (mm) B (mm)

3431541138469	-	1 - 5	200 pcs
---------------	---	-------	---------

## Auto nivelant - Self leveling

50 pcs

- ▶ Triple fonction : - nivelage automatique - espacement régulier  
alignement parfait des carreaux entre eux.  
Triple function: - automatic leveling - regular spacing - perfect  
align ment of tiles together.

2 mm



Gencode **3431541138957**

Données logistiques - Logistic informations



Box 240x80x300 mm | Master 32 x 0,45 kg  
Pal 192 | Ctr 20ft 14403 pcs

## Recharges auto nivelant - Refill for self leveling

100 pcs

2 mm



Gencode **3431541138940**

Données logistiques - Logistic informations



Box 240x80x300 mm | Master 32 x 0,30 kg  
Pal 192 | Ctr 20ft 14403 pcs

## Pince croisillon auto-nivelant - Self-leveling cross plier

Universelle

- ▶ Réglable  
Adjustable



Gencode **3431541165380**

Données logistiques - Logistic informations



Box 100x200x35 mm | Master 30x0,4 kg  
Pal 3200 | Ctr 20ft 31880 pcs

## Raclette - Squeegee

- ▶ Caoutchouc noir, monture bois  
Black rubber, wooden frame



## Grattoir à déjoindre - Grouts scraper

- ▶ Lame carbure de tungstène, 2 lames de rechange  
Blade in tungsten carbide, 2 spare blades



Gencode **3431541165144**

Données logistiques - Logistic informations



Box 105x60x390 mm | Master 24 x 0,50 kg  
Pal 432 | Ctr 20ft 17500 pcs

## Lames de rechange - Spare blade

- ▶ 3 Lames au carbure, pour la ref. 116514  
3 Carbide blades, for ref. 116514



Gencode **3431541165342**

Données logistiques - Logistic informations



DÉCAPAGE  
STRIPPING

ÉLECTROPORTATIF  
HANDPOWER TOOLS

X-FIT  
RANGE

ATELIER  
WORKSHOP

BOIS  
WOOD MACHINES

MÉTAL  
METAL MACHINES

NETTOYAGE  
CLEANING

CARRELEUR  
TILE LAYER

JARDIN FILAIRE  
GARDEN TOOLS

Plus d'info sur  
**fartools.com**

## Outil multitâches - Multi-Task tool

- Pour joint silicone  
For silicone joint



Gencode **3431541165366**

Données logistiques - Logistic informations



3 431541 165366

Box 90x50x270 mm | Master 48 x 0,10 kg  
Pal 864 | Ctr 20ft 24000 pcs

## Lisseur de joint silicone - Silicon scraper

105x75 mm



**NOUVEAU**



Gencode **3431541165236**

Données logistiques - Logistic informations



3 431541 165236

Box 215x25x140 mm | Master 32 x 0,30 kg  
Pal 768 | Ctr 20ft 35000 pcs

## Eponge biseautée - Splayed sponge

170 x 100 x 65 mm

- Coté dur et souple  
Hard and soft sides

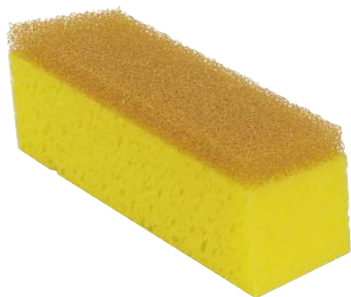

Gencode **3431541165120**

Données logistiques - Logistic informations



3 431541 165120

Box 250x10x60 mm | Master 25 x 0,05 kg  
Pal 700 | Ctr 20ft 19300 pcs

## Eponge synthétique - Synthetic sponge

200 x 115 x 50 mm

- Très absorbante  
very absorbent



Gencode **3431541165137**

Données logistiques - Logistic informations



3 431541 165137

Box 240x100x50 mm | Master 25 x 0,8 kg  
Pal 875 | Ctr 20ft 19825 pcs

## Taloche de finition - Finishing float

280 x 140 mm

- ▶ Avec semelle éponge 30 mm  
With sponge sole



Gencode **3431541165113**

Données logistiques - Logistic informations



Box 110x140x215 mm | Master 24 x 0,37 kg  
Pal 432 | Ctr 20ft 18400 pcs

3 431541 165113

## Platoir à jointer - Plastering trowel for joints

250 x 100 x 15 mm

- ▶ Semelle caoutchouc vert pour joints larges  
Green rubber sole for wide grouts



Gencode **3431541165106**

Données logistiques - Logistic informations



Box 105x60x390 mm | Master 48 x 0,47 kg  
Pal 432 | Ctr 20ft 23800 pcs

3 431541 165106

## Poches à jointoyer - Pockets for tile glue

x 3

- ▶ Idéal pour joints de pierre, faïence, carrelage...  
For joints of stone, tiles, porcelain...



Gencode **3431541165250**

Données logistiques - Logistic informations



Box 190x50x320 mm | Master 36 x 0,30 kg  
Pal 648 | Ctr 20ft 36818 pcs

3 431541 165250

## Bac de rinçage - Cleaning set

10 L

- ▶ Bac 10 L gradué, rouleau d'essorage, taloche semelle caoutchouc et taloche éponge  
Delivered with 10 L tank with handle, roll spin, float, railing and float sponge rubber sole.



Gencode **3431542110600**

Données logistiques - Logistic informations



3 431542 110600

DÉCAPAGE  
STRIPPING

ÉLECTROPORATIF  
HANDPOWER TOOLS

X-FIT  
RANGE

ATELIER  
WORKSHOP

BOIS  
WOOD MACHINES

MÉTAL  
METAL MACHINES

NETTOYAGE  
CLEANING

CARRELEUR  
TILE LAYER

JARDIN FILAIRE  
GARDEN TOOLS

Plus d'infos sur  
**far**tools.com

## Guide de carreleur - *Tile layer guide*

- ▶ Cordeau élastique extensible de 2 à 6 m  
Elastic chalk line from 2 to 6 m

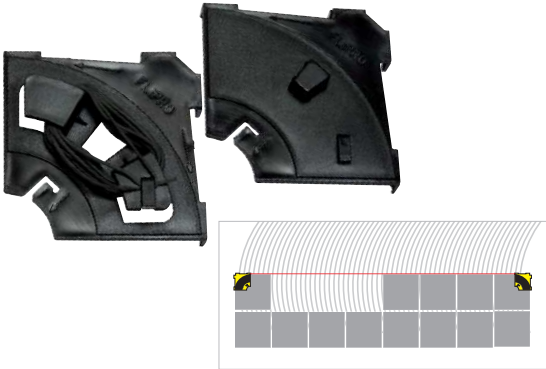

Gencode **3431542110617**

Données logistiques - *Logistic informations*



Box 25x135x190 mm | Master 30 x 0,06 kg  
Pal 540 | Ctr 20ft 15000 pcs

## Kit trappe magnétique - *Magnetic hatch kit*

13 x 6 mm

- ▶ Pour réaliser des trappes d'accès  
Enabling access hatches



Gencode **3431541165021**

Données logistiques - *Logistic informations*



Box 96x20x260 mm | Master 60 x 0,15 kg  
Pal 1800 | Ctr 20ft 8000 pcs

# L'univers du Plombier

Plumber's range

DÉBOUCHER - COUPER - SERRER - RACCORDER - CINTRER - FILETER

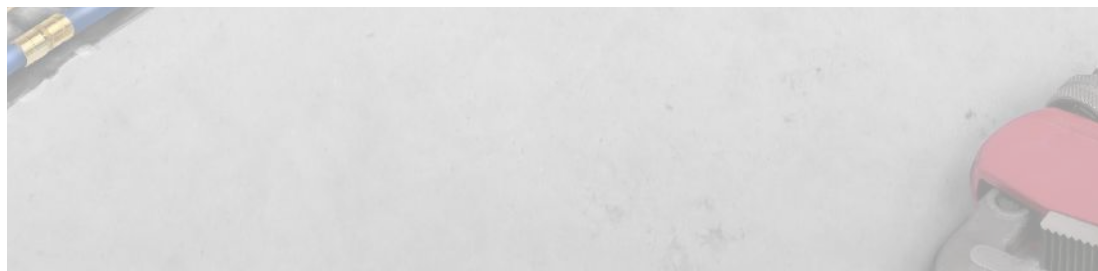
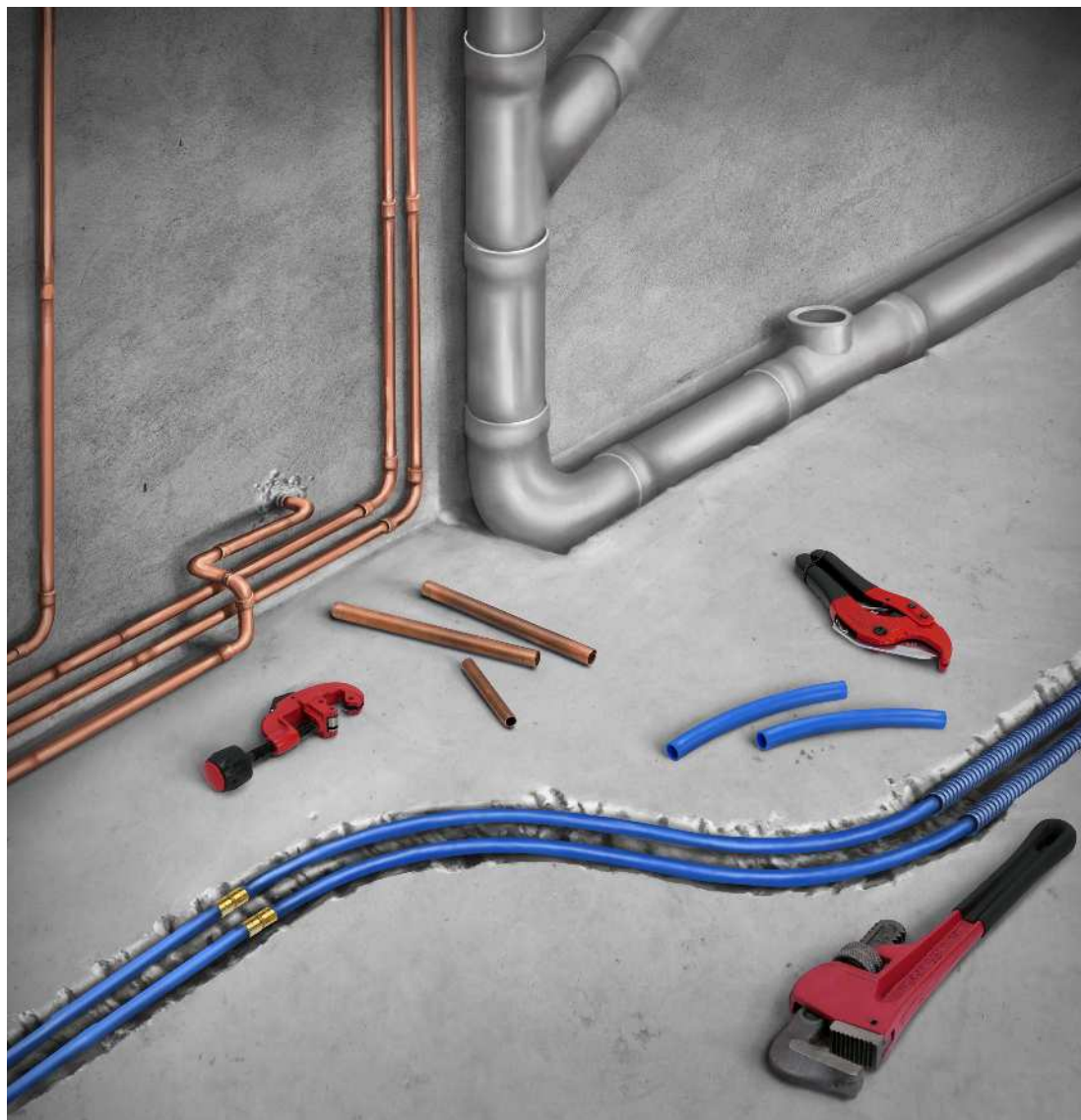

DÉCAPAGE  
STRIPPING

ÉLECTROPORATIF  
HANDPOWER TOOLS

X-FIT  
RANGE

ATELIER  
WORKSHOP

BOIS  
WOOD MACHINES

MÉTAL  
METAL MACHINES

NETTOYAGE  
CLEANING

PLOMBIER  
PLUMBER

JARDIN FILAIRE  
GARDEN TOOLS

Plus d'info sur  
[fartools.com](http://fartools.com)

# Offre complète de 1 à 2 mètres linéaires

Complete offer from 1 to 2 meters linear





## Déboucheur à poignée - Pipe cleaner

- ▶ Avec queue de cochon  
With pig tail



ø 6 mm - 3 m

3431542110143



3 431542 110143

ø 20 mm - 5 m

3431542110150



3 431542 110150

ø 20 mm - 10 m

3431542110167



3 431542 110167

## Déboucheur à tambour - Pipe cleaner

7,6 m - ø 12 mm

- ▶ Avec queue de cochon  
With pig tail



Gencode **3431542110136**

Données logistiques - Logistic informations



3 431542 110136

Box 270x160x220 mm | Master 8 x 1,00 kg  
Pal 144 | Ctr 20ft 4600 pcs

## Déboucheur à tête - Head pipe cleaner

4,1 m - ø 10 mm



Gencode **3431542110440**

Données logistiques - Logistic informations



3 431542 110440

Box 210x20x210 mm | Master 20 x 0,75 kg  
Pal 500 | Ctr 20ft 19860 pcs

## Déboucheur à Lavabo - Sink cleaner

1,5 m - ø 40 mm

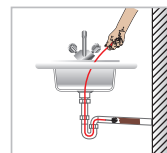
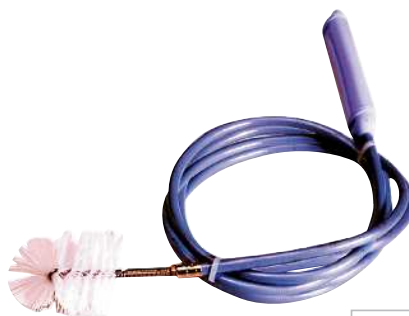

Gencode **3431542110433**

Données logistiques - Logistic informations



3 431542 110433

Box 150x20x150 mm | Master 64 x 0,20 kg  
Pal 1152 | Ctr 20ft 23000 pcs

DÉCAPAGE  
STRIPPING

ÉLECTROPORATIF  
HANDPOWER TOOLS

X-FIT  
RANGE

ATELIER  
WORKSHOP

BOIS  
WOOD MACHINES

MÉTAL  
METAL MACHINES

NETTOYAGE  
CLEANING

PLOMBIER  
PLUMBER

JARDIN FILAIRE  
GARDEN TOOLS

Plus d'infos sur  
**fartools.com**

## Déboucheur à lavabo - Sink cleaner

3 m - ø 8 mm



Gencode **3431542110457**

Données logistiques - Logistic informations



Box 190x30x190 mm | Master 8 x 0,60 kg  
Pal 512 | Ctr 20ft 20304 pcs

## Déboucheur à WC - Toilet plunger

0,9 m

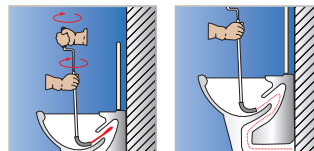

Gencode **3431542110464**

Données logistiques - Logistic informations



Box 180x50x900 mm | Master 24 x 0,76 kg  
Pal 504 | Ctr 20ft 10824 pcs

## Déboucheur pompe à vide - Vacuum pump

0,65 L - ø 70 & 150 mm



Gencode **3431542110327**

Données logistiques - Logistic informations



Box 240x110x440 mm | Master 24 x 0,50 kg  
Pal 288 | Ctr 20ft 11500 pcs

## Déboucheur ventouse - Plunger

ø 140 mm



Gencode **3431542110341**

Données logistiques - Logistic informations



Box 150x150x520 mm | Master 12 x 0,2 kg  
Pal 324 | Ctr 20ft 8088 pcs

## Mini coupe-tubes - Mini pipe cutter

ø 3 - 22 mm



Gencode **3431542110044**

Données logistiques - Logistic informations



Box 30x65x215 mm | Master 50 x 0,10 kg  
Pal 2700 | Ctr 20ft 57500 pcs

## Coupe-tube Standard

Standard pipe cutter

► ø 3 - 30 mm



Gencode **3431542110051**

Données logistiques - Logistic informations



Box 65x30x215 mm | Master 36 x 0,15 kg  
Pal 1296 | Ctr 20ft 41400 pcs

## Coupe-tube télescopique

Telescopic pipe cutter

► ø 3 - 32 mm



Gencode **3431542110068**

Données logistiques - Logistic informations



Box 40x65x215 mm | Master 36 x 0,20 kg  
Pal 1296 | Ctr 20ft 41400 pcs

Consommables - Consumables

Molette - Blade

**3431542118040**

DÉCAPAGE  
STRIPPING

ÉLECTROPORTATIF  
HANDPOWER TOOLS

X-FIT  
RANGE

ATELIER  
WORKSHOP

BOIS  
WOOD MACHINES

MÉTAL  
METAL MACHINES

NETTOYAGE  
CLEANING

PLOMBIER  
PLUMBER

JARDIN FILAIRE  
GARDEN TOOLS

Plus d'info sur  
**fartools.com**

**Pince coupe-tube - Cutting pliers**  
PER-PVC-PEX-MULTICOUCHE-ABS



Gencode **3431542117012**

Données logistiques - Logistic informations



Box 140x30x215 mm | Master 24 x 0,35 kg  
Pal 432 | Ctr 20ft 10000 pcs

**Pince multiprise - Multigrip pliers**  
ø 75 mm maxi



- ▶ à mâchoires rondes, 235 mm  
With round jaws, 235 mm

Gencode **3431542110310**

Données logistiques - Logistic informations



Box 20x80x280 mm | Master 24 x 0,30 kg  
Pal 1224 | Ctr 20ft 57500 pcs

**Clé à robinet - Sink tap key**  
ø 13 mm

- ▶ Clé ø 13 mm avec 5 embouts ø 8-9-10-11-12-13 mm  
13 mm Key with 5 bits ø 8-9-10-11-12-13 mm

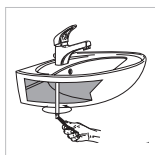

Gencode **3431542110365**

Données logistiques - Logistic informations



Box 150x150x520 mm | Master 48 x 0,37 kg  
Pal 816 | Ctr 20ft 23184 pcs

**Clef à chaîne - Chain pipe wrench**



Gencode **3431542110273**

Données logistiques - Logistic informations



Box 30x65x370 mm | Master 20 x 0,95 kg  
Pal 600 | Ctr 20ft 23000 pcs

## Clé lavabo télescopique

*Telescopic wrench for basin*

- ▶ 431 mm, mâchoire de 35 mm  
431 mm, with 35 mm jaw



Gencode **3431542110266**

Données logistiques - Logistic informations



3 431542 110266

Box 140x25x350 mm | Master 24 x 0,85 kg  
Pal 576 | Ctr 20ft 17250 pcs

## Clef suédoise - Swedish wrench



ø 25 mm

**3431542110280**



3 431542 110280

ø 40 mm

**3431542110297**



3 431542 110297

ø 50 mm

**3431542110303**



3 431542 110303

## Clef Stillson - Stillson wrench



ø 38 mm

**3431542110082**



3 431542 110082

ø 50 mm

**3431542110099**



3 431542 110099

ø 62 mm

**3431542110105**



3 431542 110105

DÉCAPAGE  
STRIPPING

ÉLECTROPORATIF  
HANDPOWER TOOLS

X-FIT  
RANGE

ATELIER  
WORKSHOP

BOIS  
WOOD MACHINES

MÉTAL  
METAL MACHINES

NETTOYAGE  
CLEANING

PLOMBIER  
PLUMBER

JARDIN FILAIRE  
GARDEN TOOLS

Plus d'info sur  
**fartools.com**

## Pince à cintrer - *Bending pliers*

- Pour cuivre recuit  
For annealed copper



ø 10-12 mm

3431542110198



3 431542 110198

ø 12-14 mm

3431542110204



3 431542 110204

ø 14-16 mm

3431542110211



3 431542 110211

## Appareil à emboîture universel

*Universal socket device*

- ø 8 à 16 mm  
ø 8 to 16 mm



Gencode **3431542110075**

Données logistiques - *Logistic informations*



3 431542 110075

Box 65x25x215 mm | Master 50 x 0,25 kg  
Pal 900 | Ctr 20ft 57500 pcs

## Ensemble à battre les collets

*Kit for hammering collars*

- ø 6 à 15 mm  
ø 6 to 15 mm



Gencode **3431542110020**

Données logistiques - *Logistic informations*



3 431542 110020

Box 40x140x245 mm | Master 20 x 0,80 kg  
Pal 600 | Ctr 20ft 23000 pcs

## Coffret 5 filières - 5 pcs ratchet die stocks

- 3/8", 1/2", 3/4", 1", 1, 1/4" + porte filières  
3/8", 1/2", 3/4", 1", 1, 1/4" + die holder



Gencode **3431542116305**

Données logistiques - *Logistic informations*



3 431542 116305

Box 400x90x210 mm | Master 4 x 5,2 kg  
Pal 72 | Ctr 20ft 3500 pcs

## Filière - Die stock



## Rodeur de robinet - Tap grinding tool

- Double cône laiton fraises 10, 12, 13, 14, 15, 17  
Brass double cone milling cutter 10, 12, 13, 14, 15, 17

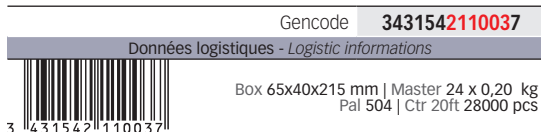

## Emporte-pièces - Punch cutter ø 32 mm

- 3 Pointes pour perçage propre des tôles  
3 tips for clean drilling of sheets

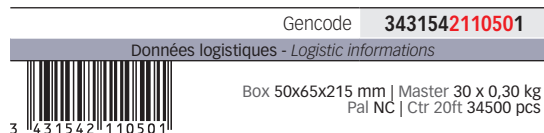

## Coffret pour raccord à glissement PER PER tube setting box

- Par glissement (ø 12 - 16 - 20 mm)  
For sliding connection (ø 12 - 16 - 20 mm)

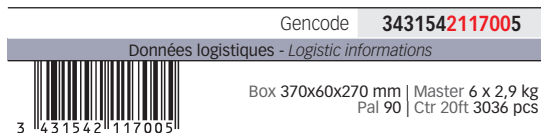

DÉCAPAGE  
STRIPPING

ÉLECTROPORTATIF  
HANDPOWER TOOLS

X-FIT  
RANGE

ATELIER  
WORKSHOP

BOIS  
WOOD MACHINES

MÉTAL  
METAL MACHINES

NETTOYAGE  
CLEANING

PLOMBIER  
PLUMBER

JARDIN FILAIRE  
GARDEN TOOLS

Plus d'infos sur  
**fartools.com**

L'univers du  
**Soudeur**

Welder's range

PRÉPARER - SE PROTÉGER - FIXER - SOUDER - NETTOYER

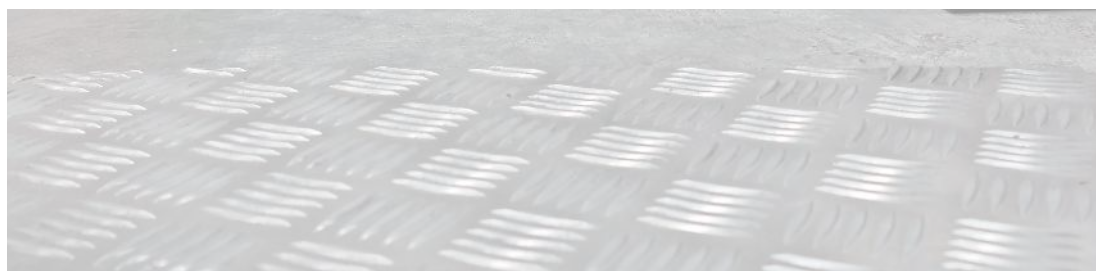

DÉCAPAGE  
STRIPPING

ÉLECTROPORTATIF  
HANDPOWER TOOLS

X-FIT  
RANGE

ATELIER  
WORKSHOP

BOIS  
WOOD MACHINES

MÉTAL  
METAL MACHINES

NETTOYAGE  
CLEANING

**SOUDEUR**  
WELDER

JARDIN FILAIRE  
GARDEN TOOLS

Plus d'info sur  
**fartools.com**



# Offre complète de 1 à 2 mètres linéaires

Complete offer from 1 to 2 meters linear



## Baguettes acier - Rutile steel

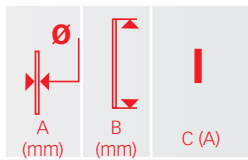

	A (mm)	B (mm)	C (A)	
3431541507043	1,6	300	30 - 60	25 pcs
3431541507036	1,6	300	30 - 60	50 pcs
3431541507005	2,5	300	60 - 100	25 pcs
3431541507050	2,5	300	60 - 100	50 pcs
3431541507012	3,2	350	80 - 150	8 pcs
3431541507067	3,2	350	80 - 150	25 pcs

## Bobine fil fourré - Gas-free coil

ø 0,8 mm



Gencode **3431541503502**

Données logistiques - Logistic informations



Box 105x55x105 mm | Master 20 x 0,55 kg  
Pal 600 | Ctr 20ft 35600 pcs

## Porte électrodes - Electrode holder

500 A

► Laiton  
Brass



Gencode **3431541505001**

Données logistiques - Logistic informations



Box 295x10x100 mm | Master 30 x 0,45 kg  
Pal 540 | Ctr 20ft 27900 pcs

## Pince de masse - Earth clamp

500 A

► Peinture laiton  
Brass Coated



Gencode **3431541505025**

Données logistiques - Logistic informations



Box 275x40x90 mm | Master 30 x 0,30 kg  
Pal 540 | Ctr 20ft 25500 pcs

DÉCAPAGE  
STRIPPING

ÉLECTROPORTATIF  
HANDPOWER TOOLS

X-FIT  
RANGE

ATELIER  
WORKSHOP

BOIS  
WOOD MACHINES

MÉTAL  
METAL MACHINES

NETTOYAGE  
CLEANING

SOUDEUR  
WELDER

JARDIN FILAIRE  
GARDEN TOOLS

Plus d'infos sur  
**fartools.com**

**Pince étau - Locking pliers**

30 mm



Gencode **3431541505087**

Données logistiques - Logistic informations



Box 285x25x70 mm | Master 30 x 0,45 kg  
Pal 1200 | Ctr 20ft 58800 pcs

**Pince étau - Locking pliers**

65 mm



Gencode **3431541505100**

Données logistiques - Logistic informations



Box 295x40x100 mm | Master 30 x 0,45 kg  
Pal 540 | Ctr 20ft 27900 pcs

**Pince étau crocodile - Locking pliers**

55 mm



Gencode **3431541505094**

Données logistiques - Logistic informations



Box 275x20x65 mm | Master 50 x 0,35 kg  
Pal 1500 | Ctr 20ft 67700 pcs

**Pince étau bec large - Large locking pliers**

22 mm



Gencode **3431541505117**

Données logistiques - Logistic informations



Box 300x95x65 mm | Master 30 x 0,80 kg  
Pal 900 | Ctr 20ft 57800 pcs

## Etou angulaire - *Angular vice* 68 mm



Gencode **3431541505155**

Données logistiques - *Logistic informations*



Box 285x25x70 mm | Master 30 x 0,45 kg  
Pal 1200 | Ctr 20ft 58800 pcs

## Positionneur d'angle magnétique *Magnetic angle positionner*



5" - 125 mm

**3431541505148**



4" - 100 mm

**3431541505131**



## Cisaille à tôle - Steel sheet shear



Gencode **3431541505070**

Données logistiques - Logistic informations



Box 305x30x80 mm | Master 36 x 0,37 kg  
Pal 972 | Ctr 20ft 27500 pcs

## Marteau manche ressort

Spring handle hammer



Gencode **3431541505049**

Données logistiques - Logistic informations



Box 335x40x125 mm | Master 39 x 0,30 kg  
Pal 1170 | Ctr 20ft 34500 pcs

## Brosse à laitier - Welding brush



Gencode **3431541505186**

Données logistiques - Logistic informations



Box 350x50x65 mm | Master 40 x 0,15 kg  
Pal NC | Ctr 20ft 3700 pcs

## Masque de soudure - Welding mask

► Version économique  
Economic version

DIN  
10



Gencode **3431541505179**

Données logistiques - Logistic informations



Box 285x90x470 mm | Master 12 x 0,20 kg  
Pal 144 | Ctr 20ft 5121 pcs

**DIN 13**

42,5 x 92,5 mm



- ▶ Automatique : à cristaux liquides  
Automatic: liquid crystal
- ▶ Temps du clair au sombre : 0,03 ms  
Light to dark time: 0,03 ms
- ▶ Serre-tête matelassé réglable par molette  
Easy head size adjustment (with foam)

**DIN 13**

		Type de machine - Machine type				
A		MMA	MIG	MAG	TIG	PLASMA
intensité du courant utilisé Current intensity used	1	DIN 8			DIN 8	DIN 8
	2,5					DIN 7
	5					
	10					DIN 8
	20				DIN 9	DIN 9
	30	DIN 9			DIN 10	DIN 10
	40					DIN 11
	60	DIN 10		DIN 9	DIN 11	
	80					DIN 12
	100	DIN 11	DIN 10	DIN 10	DIN 12	
	150		DIN 11	DIN 11	DIN 13	DIN 13
	175					
	200	DIN 12	DIN 12	DIN 12		
	225					DIN 14
	250				DIN 13	DIN 14
	300					
	350	DIN 13	DIN 13	DIN 14		
400						
450					DIN 15	
500	DIN 14	DIN 14	DIN 15			

Niveau d'obscurité du verre pour la protection oculaire  
Dark state filter for eyes protection



Masque de soudure AUTOMATIQUE - Welding helmet	<b>WH 13D</b>
Gencode	<b>3431541505032</b>
DIN degré de protection - Protection degree	<b>DIN 13 (9&gt;13)</b>
Alimentation - Power supply	<b>Solaire</b>
Mode meulage - Grinding mode	<b>Oui</b>
Temps du clair au sombre - Light to dark time	<b>0,03 ms</b>
Temps de réaction réglable - Adjustable reaction time	<b>de 0,1 à 0,8 s</b>
Poids - Weight	<b>450 g</b>
Données logistiques - Logistic informations	



Box 330x240x230 mm | Master 6x0,80 kg | Pal 54 pcs | Ctr 20ft 1440 pcs

# Masque de soudure automatique - Automatic welding mask - WHP 13

**DIN 13**  
60 x 110 mm



- ▶ Automatique : à cristaux liquides  
Automatic: liquid crystal
- ▶ Réglage de la sensibilité du filtre : 0,03 ms  
Filter sensitivity adjustment: 0.03 ms
- ▶ Serre-tête confort 4 points  
4-point comfort headband
- ▶ Coussins intégrés à l'arrière de la tête  
Cushions integrated at the back of the head

**DIN 13**

Livré avec une visière intégrale de rechange  
Delivered with an extra spare shield visor



Vision panoramique à 180°  
Panoramic vision 180°



		Type de machine - Machine type				
A		MMA	MIG	MAG	TIG	PLASMA
intensité du courant utilisé Current intensity used	1	DIN 8			DIN 8	DIN 8
	2,5					DIN 7
	5					
	10					DIN 8
	20				DIN 9	DIN 9
	30	DIN 9			DIN 10	DIN 10
	40					DIN 11
	60	DIN 10		DIN 9	DIN 11	
	80					DIN 12
	100	DIN 11	DIN 10	DIN 10	DIN 12	
	150		DIN 11	DIN 11	DIN 13	DIN 13
	175					
	200	DIN 12	DIN 12	DIN 12		
	225					DIN 14
	250			DIN 13	DIN 14	
	300					
	350	DIN 13	DIN 13	DIN 14		
400						
450					DIN 15	
500	DIN 14	DIN 14	DIN 15			

Niveau d'obscurité du verre pour la protection oculaire  
Dark state filter for eyes protection



Masque de soudure AUTOMATIQUE - Welding helmet	WHP 13
Gencode	<b>3431541505254</b>
DIN degré de protection - Protection degree	<b>DIN 13 (9&gt;13)</b>
DIN degré de protection latérale - Lateral protection degree	<b>DIN 5</b>
Alimentation - Power supply	<b>Solaire</b>
Mode meulage - Grinding mode	<b>Oui</b>
Temps du clair au sombre - Light to dark time	<b>0,03 ms</b>
Temps de réaction réglable - Adjustable reaction time	<b>de 0,1 à 1 s</b>
Poids - Weight	<b>520 g</b>

Données logistiques - Logistic informations



Box 330x240x230 mm | Master 6x0,80 kg | Pal 54 pcs | Ctr 20ft 1440 pcs

L'univers du

# Parqueteur

Flooring's range

DÉCOUPER - INSTALLER - RÉPARER



**NOUVEAU**

DÉCAPAGE  
STRIPPING

ÉLECTROPORTATIF  
HANDPOWER TOOLS

X-FIT  
RANGE

ATELIER  
WORKSHOP

BOIS  
WOOD MACHINES

MÉTAL  
METAL MACHINES

NETTOYAGE  
CLEANING

PARQUETEUR  
PARQUET LAYER

JARDIN FILAIRE  
GARDEN TOOLS

Plus d'info sur  
**fartools.com**



# Guillotine pour parquet sol stratifié - Floor cutter - LFC 305

305 mm

**NOUVEAU**



Coupe droite et nette  
Straight and clean cut



Butée de coupe réglable  
Adjustable depth stop

- ▶ Coupe rectiligne rapide, propre et droite  
Quick straight cut, clean and straight
- ▶ Pas de poussière et sans effort  
No dust and no effort
- ▶ Butée de coupe réglable  
Adjustable depth stop
- ▶ Coupe sans bruit  
Noiseless cutting
- ▶ Lame inusable et non tranchante  
Hard-wearing, non-sharp blade
- ▶ Poignée ergonomique  
Ergonomic handle

Livré avec support de lame de parquet  
Delivered with support

Guillotine coupe parquet - wood flooring cutter	LFC 305
Gencode	3431542130004
Longueur de coupe maxi - Max cutting Length	305 mm
Epaisseur de coupe maximum - Maximum cutting thickness	12 mm
Données logistiques - Logistic informations	



Box 790x450x380 mm | Master 4x2,2 kg | Pal 90 pcs | Ctr 20ft 750 pcs

# Coupe lame pour sol PVC et lino - Floor cutter - LFC 300

300 mm

**NOUVEAU**



Coupe droite et nette  
Straight and clean cut



Base graduée  
Graduated base

- ▶ Coupe rectiligne rapide, propre et droite  
Quick straight cut, clean and straight
- ▶ Pas de poussière et sans effort  
No dust and no effort
- ▶ Coupe sans bruit  
Noiseless cutting
- ▶ Lame inusable et non tranchante  
Hard-wearing, non-sharp blade
- ▶ Poignée ergonomique  
Ergonomic handle

Coupe lame pour sol PVC et Lino - wood flooring cutter

LFC 300

Gencode **3431542130011**

Longueur de coupe maxi - Max cutting Length

**300 mm**

Épaisseur de coupe maximum - Maximum cutting thickness

**5 mm**

Données logistiques - Logistic informations



3 431542 130011

Box 710x250x140 mm | Master 8x6,00 kg | Pal 90 pcs | Ctr 20ft 890 pcs

DÉCAPAGE  
STRIPPING

ÉLECTROPORATIF  
HANDPOWER TOOLS

X-FIT  
RANGE

ATELIER  
WORKSHOP

BOIS  
WOOD MACHINES

MÉTAL  
METAL MACHINES

NETTOYAGE  
CLEANING

PARQUETEUR  
PARQUET LAYER

JARDIN FILAIRE  
GARDEN TOOLS

Plus d'info sur  
**fartools.com**

# Kit de réparation parquet - Floor repair kit - KP3

3,7 V

**NOUVEAU**



Mélanger pour trouver la couleur  
Mix to find the color



Nettoyer, c'est invisible !  
Cleaning, it is invisible!

- ▶ Réparation rapide des trous et éraflures sur tous types de parquet (naturel, stratifié et vinyl)  
Quick repair of holes and scratches on all types of parquet (natural, laminate and vinyl)
- ▶ Facile d'utilisation  
Easy to use
- ▶ 11 batons de cire, pour s'adapter à n'importe quelle couleur de parquet  
11 wax sticks, to match any parquet color
- ▶ Résultat durable et esthétique  
Long-lasting and aesthetic result

Livré en mallette avec 11 batons de cire, chiffon et éponge de nettoyage, grattoirs et câble de recharge  
Delivered in plastic box with 11 wax sticks, cleaning cloth and sponge, scrapers and charging cable

Kit de réparation de parquet - Floor repair kit	KP3
Gencode	<b>3431542130073</b>
Tension et puissance de la batterie - Battery voltage and power	<b>3,7 V - 1200 mAh</b>
Temps de charge indicatif - Indicative charge time	<b>2 H</b>
Température de travail - Working temperature	<b>200° C</b>

Données logistiques - Logistic informations



3 431542 130073

Box 870x155x270 mm | Master 1 x 8,00 kg | Pal 30 pcs | Ctr 20ft 1000 pcs

## Kit de pose parquet stratifié

Parquet installation kit

**NOUVEAU**



- ▶ 20 cales + 1 batte + 1 tire lames  
20 wedges + 1 bat + 1 blade puller

Gencode **3431542130028**

Données logistiques - Logistic informations



Box 620x540x230 mm | Master 36 x 0,75 kg  
Pal 972 | Ctr 20ft 27500 pcs

## Set de 20 cales - Set of 20 wedges

**NOUVEAU**



- ▶ De 2 à 7 mm d'épaisseur  
From 2 to 7 mm thick

Gencode **3431542130035**

Données logistiques - Logistic informations



Box 170x280x280 mm | Master 39 x 0,13 kg  
Pal 1170 | Ctr 20ft 34500 pcs

## Kit de pose parquet PRO

Parquet installation kit

**NOUVEAU**



Gencode **3431542130042**

Données logistiques - Logistic informations



Box 635x215x525 mm | Master 9 x 2,12 kg  
Pal 900 | Ctr 20ft 3700 pcs

DÉCAPAGE  
STRIPPING

ÉLECTROPORTATIF  
HANDPOWER TOOLS

X-FIT  
RANGE

ATELIER  
WORKSHOP

BOIS  
WOOD MACHINES

MÉTAL  
METAL MACHINES

NETTOYAGE  
CLEANING

PARQUETEUR  
PARQUET LAYER

JARDIN FILAIRE  
GARDEN TOOLS

Plus d'info sur  
**fartools.com**

# L'univers Jardin

Garden tools range

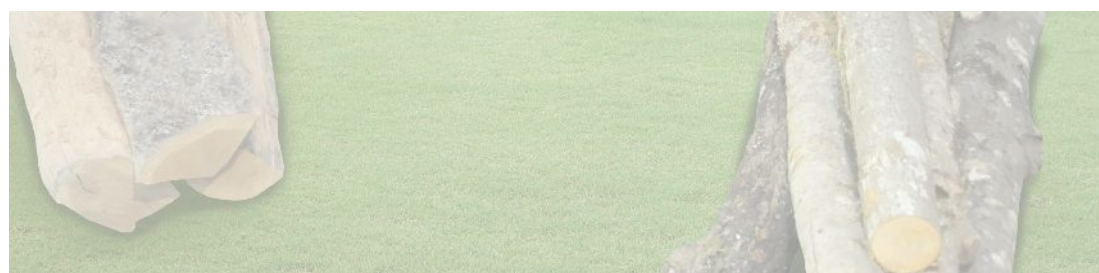
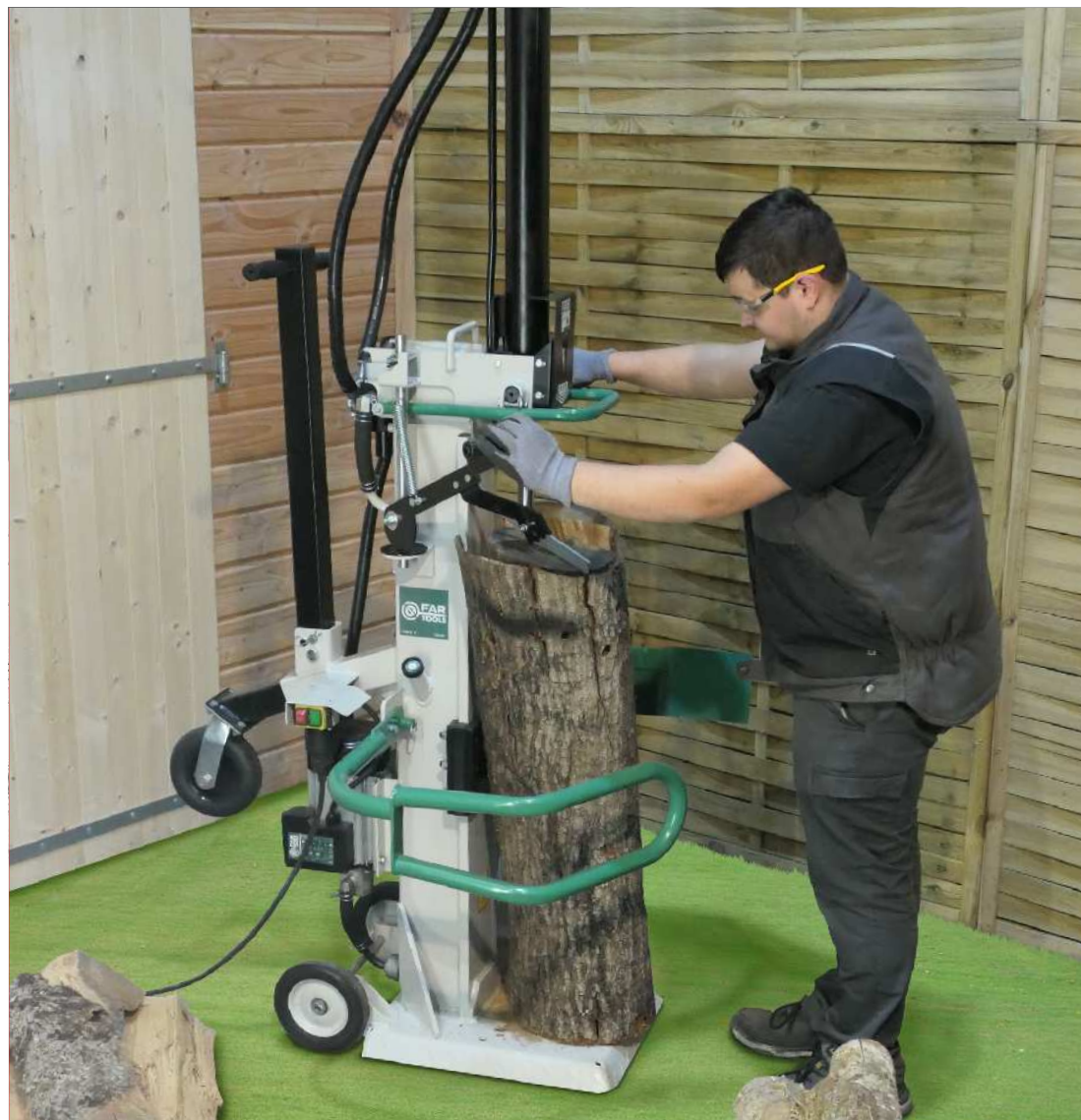

DÉCAPAGE  
STRIPPING

ÉLECTROPORTATIF  
HANDPOWER TOOLS

X-FIT  
RANGE

ATELIER  
WORKSHOP

BOIS  
WOOD MACHINES

MÉTAL  
METAL MACHINES

NETTOYAGE  
CLEANING

PARQUETEUR  
PARQUET LAYER

JARDIN  
GARDEN

Plus d'info sur  
[fartools.com](http://fartools.com)

# Scie à bûches - Log saw - LS 405I

ø 405 mm  
2200 W

**NOUVEAU**

**SECONDE GÉNÉRATION :  
PRÉMONTAGE BLOC MOTEUR / LAME /  
CARTER**  
SECOND GENERATION  
PREASSEMBLY OF THE MOTOR / BLADE / CARTER

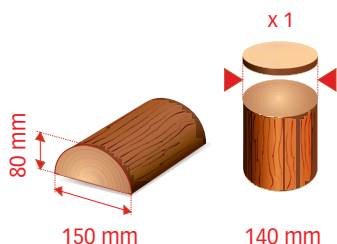

Carter de protection  
Safety cover

- ▶ Alimentation monophasée 230V~50Hz  
Single phase current 230V~50Hz
- ▶ Pliable pour un gain de place  
Foldable for space saving
- ▶ Extension porte-bûches  
Logs holder extension
- ▶ Butée de longueur  
Length stop

Scie à bûches - 16" Log saw		LS 405I
	Gencode	<b>3431541820067</b>
Puissance du moteur - Motor power (230V-50Hz)		<b>2200 W</b>
Dimensions de la lame - Blade sizes		<b>405x30 mm</b>
Nombre de dents - Teeth number		<b>40 T</b>
Diamètre de coupe direct - Direct cutting diameter		<b>ø 125 mm</b>
Diamètre de coupe maximum - Maximum cutting diameter		<b>ø 140 mm Max</b>
Vitesse de rotation - Rotation speed		<b>2800 tr/min</b>
Niveau de bruit - Noise level		<b>92-104 dB (*: 3dB)</b>
Données logistiques - Logistic informations		
3 431541 820067   Box 1060x233x770 mm   Master 1 x 36,3 kg   Pal 3 pcs   Ctr 20ft 145 pcs		
Consommables - Consumables		
Lame 32T - 32T blade		<b>3431541138377</b>

# Scie à bûches - Log saw - LS 505E

ø 505 mm  
2600 W

**NOUVEAU**

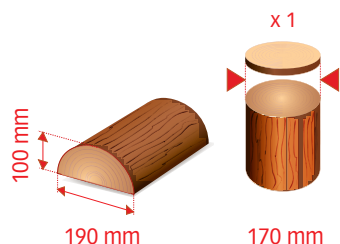

Carter de protection  
Safety cover

- ▶ **Alimentation monophasée 230V-50Hz**  
Single phase current 230V-50Hz
- ▶ **Grande capacité de coupe**  
Big cutting capacities
- ▶ **Roues de transport**  
Transportation wheels
- ▶ **Extension porte-bûches**  
Logs holder extension
- ▶ **Butée de longueur**  
Length stop
- ▶ **Grande poignée de manœuvre du banc de sciage**  
Big working handle of sawing bank

*Livrée pré montée*  
Delivered pre assembled

Scie à bûches - 20" Log saw	LS 505E
Gencode	<b>3431541820104</b>
Puissance du moteur - Motor power (230V-50Hz)	<b>2600 W</b>
Dimensions de la lame - Blade sizes	<b>505x30 mm</b>
Nombre de dents - Teeth number	<b>40 T</b>
Diamètre de coupe direct - Direct cutting diameter	<b>ø 170 mm</b>
Diamètre de coupe maximum - Maximum cutting diameter	<b>ø 190 mm Max</b>
Vitesse de rotation - Rotation speed	<b>2800 tr/min</b>
Niveau de bruit - Noise level	<b>93-108 dB (+/- 3dB)</b>
Données logistiques - Logistic informations	
Box 800x760x1060 mm   Master 1 x 74,0 kg   Pal 1 pcs   Ctr 20ft 60 pcs	
Consommables - Consumables	
Lame 40T - 40T blade	<b>3431541138889</b>



3 431541 820104

Box 800x760x1060 mm | Master 1 x 74,0 kg | Pal 1 pcs | Ctr 20ft 60 pcs

Consommables - Consumables

Lame 40T - 40T blade

3431541138889

DÉCAPAGE  
STRIPPING

ÉLECTROPORATIF  
HANDPOWER TOOLS

X-FIT  
RANGE

ATELIER  
WORKSHOP

BOIS  
WOOD MACHINES

MÉTAL  
METAL MACHINES

NETTOYAGE  
CLEANING

PARQUETEUR  
PARQUET LAYER

JARDIN  
GARDEN

Plus d'info sur  
**far.tools.com**

# Scie à bûches - Log saw - LS 700D

ø 700 mm  
3500 W

# XL

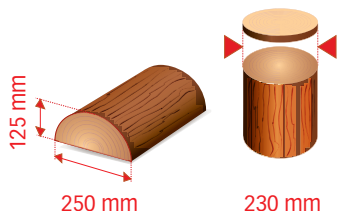

YouTube



Carter de protection  
Safety cover



Poignée de transport  
Transportation handle

- ▶ **Alimentation monophasée 230V~50Hz**  
Single phase current 230V~50Hz
- ▶ **Grande capacité de coupe**  
Big cutting capacities
- ▶ **Roues de transport**  
Transportation wheels
- ▶ **Extension porte-bûches**  
Logs holder extension
- ▶ **Butée de longueur**  
Length stop
- ▶ **Double poignée de manœuvre du banc de sciage**  
Double working handle of sawing bank

*Livrée pré montée*  
Delivered pre assembled

Scie à bûches - 28" Log saw		LS 700D
Gencode		<b>3431541820111</b>
Puissance du moteur - Motor power (230V~50Hz)		<b>3500 W</b>
Dimensions de la lame - Blade sizes		<b>700x30 mm</b>
Nombre de dents - Teeth number		<b>42 T</b>
Diamètre de coupe direct - Direct cutting diameter		<b>ø 230 mm</b>
Diamètre de coupe maximum - Maximum cutting diameter		<b>ø 250 mm Max</b>
Vitesse de rotation - Rotation speed		<b>1400 tr/min</b>
Niveau de bruit - Noise level		<b>104-106 dB (+/- 2dB)</b>
<i>Données logistiques - Logistic informations</i>		
 Box 970x760x1260 mm   Master 1 x 120,0 kg   Pal 1 pcs   Ctr 20ft 40 pcs		
<i>Consommables - Consumables</i>		
Lame 42T - 42T blade		<b>3431541138872</b>
Housse de protection - Protective cover		<b>3431541800722</b>





## ECRAN BÛCHERONNAGE

### LOGGING SCREEN

Vidéos sur les scies à bûches et fendeurs, horizontaux et verticaux

Videos available for log splitter & log saw videos.



## TOTEM BÛCHERONNAGE

### LOGGING TOTEM

— 4 cubes 4 cubes

140317

4 cubes carton enclipsables

4 snap-on cardboard cubes

#### DIMENSIONS cube :

- ° Largeur *Width* : 38 cm
- ° Profondeur *Depth* : 38 cm
- ° Hauteur *Height* : 38 cm

#### DIMENSIONS totales :

- ° Largeur *Width* : 161 cm
- ° Profondeur *Depth* : 38 cm
- ° Hauteur *Height* : 38 cm

## IMPLANTATION MAGASIN

### STORE IMPLANTATION

Exemple type d'une implantation jardin réussie :  
Typical example of a successful garden establishment:

- ° Utilisation des totems *Use of totems*
- ° Mise en avant des produits *Highlighting of products*
- ° Décoration adéquate *Adequate decoration*



DÉCAPAGE  
STRIPPING

ÉLECTROPORATIF  
HANDPOWER TOOLS

X-FIT  
RANGE

ATELIER  
WORKSHOP

BOIS  
WOOD MACHINES

MÉTAL  
METAL MACHINES

NETTOYAGE  
CLEANING

PARQUETEUR  
PARQUET LAYER

JARDIN  
GARDEN

Plus d'info sur  
[fartools.com](http://fartools.com)

# Fendeur de bûches - Log splitter - FBH 6TC

520 mm  
6 Tonnes

**NOUVEAU**

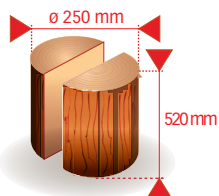

**PRODUIT MALIN**  
SMART PRODUCT



CROIX DE FENDAGE  
CROSS SPLITTER

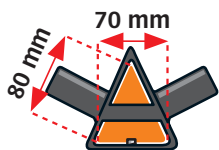

Ajustable →  
(h : 125 mm)

3431541820517



3 431541 820517

- ▶ Alimentation monophasée 230V-50Hz  
Single phase current 230V-50Hz
- ▶ Pour fendre des bûches de 520 mm  
To split 520 mm logs
- ▶ Machine compacte  
Compact machine
- ▶ Travail debout  
Standing work
- ▶ Roues de transport  
Transportation wheels

Bûches de 50 cm



Spécial cheminée, insert  
Special fire place

Fendeur de bûches - Log splitter

FBH 6TC

Gencode **3431541820364**

Puissance du moteur - Motor power (230V-50Hz)	2200 W (S3) Alu
Longueur de la bûche - Log length	250-520 mm
Diamètre de la bûche - Log diameter	50 - 250 mm
Force de poussée - Thrust power	6 T / 20,8 Mpa
Vitesse de rotation - Rotation speed	2800 tr/min
Niveau de bruit - Noise level	91 dB (+/- 3dB)

Données logistiques - Logistic informations

3 431541 820364 Box 300x480x1000 mm | Master 1 x 50,0 kg | Pal 6 pcs | Ctr 20ft 215 pcs

Consommables - Consumables

Croix de fendage en 4 - Cross splitter

3431541820517

# Fendeur de bûches rapide - Quick log splitter - FBH 7T

520 mm  
7 Tonnes



**3**  
**X**

**plus rapide**  
qu'un fendeur traditionnel hydraulique !\*

**faster**  
than a traditional hydraulic splitter!\*



- ▶ 3 fois plus rapide\*  
3 times faster
- ▶ Alimentation monophasée 230V-50Hz  
Single phase current 230V-50Hz
- ▶ Pour fendre des bûches de 520 mm  
To split 520 mm logs
- ▶ Roues de transport  
Transportation wheels

Bûches de 50 cm



Spécial cheminée, insert  
Special fire place

Fendeur de bûches rapide - Quick log splitter	FBH 7T
Gencode	3431541820371
Puissance du moteur - Motor power (230V-50Hz)	1050 W
Longueur de la bûche - Log length	250-520 mm
Diamètre de la bûche - Log diameter	50 - 250 mm
Force de poussée - Thrust power	7 T / 17,5 Mpa
Vitesse de rotation - Rotation speed	2800 tr/min
Niveau de bruit - Noise level	78 dB (+/- 3dB)
Données logistiques - Logistic informations	



3 431541 820371

Box 1110x325x440 mm | Master 1 x 65,0 kg | Pal 4 pcs | Ctr 20ft 65 pcs

DÉCAPAGE  
STRIPPING

ÉLECTROPORATIF  
HANDPOWER TOOLS

X-FIT  
RANGE

ATELIER  
WORKSHOP

BOIS  
WOOD MACHINES

MÉTAL  
METAL MACHINES

NETTOYAGE  
CLEANING

PARQUETEUR  
PARQUET LAYER

JARDIN  
GARDEN

Plus d'info sur  
fartools.com

# Fendeur de bûches - Log splitter - FORCE 8ECO

550 mm  
8 Tonnes

**NOUVEAU**

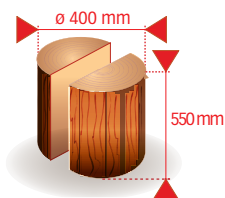

- ▶ **Alimentation monophasée 230V-50Hz**  
Single phase current 230V-50Hz
- ▶ **Grande capacité de fendage**  
Big splitting capacities
- ▶ **Travail debout**  
Standing work
- ▶ **Roues de transport**  
Transportation wheels

Transport facilité  
Easy to transport



Moteur aluminium  
Aluminium motor

Fendeur de bûches - Log splitter

**FORCE 8ECO**

Gencode **3431541820388**

Puissance du moteur - Motor power (230V-50Hz)

**3000 W**

Longueur de la bûche - Log length

**550 mm**

Diamètre de la bûche - Log diameter

**70 - 400 mm**

Force de poussée - Thrust power

**8 T / 24 Mpa**

Vitesse de rotation - Rotation speed

**2800 tr/min**

Données logistiques - Logistic informations



Box 560x380x1060 mm | Master 1 x 92,0 kg | Pal 1 pcs | Ctr 20ft 90 pcs

# Fendeur de bûches - Log splitter - FORCE 11

1040 mm  
11 Tonnes

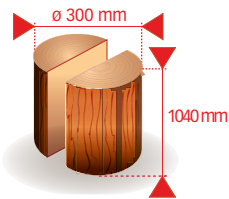

Transport facilité  
Easy to transport



Moteur aluminium  
Aluminium motor

- ▶ Alimentation monophasée 230V-50Hz  
Single phase current 230V-50Hz
- ▶ Grande capacité de fendage  
Big splitting capacities
- ▶ Travail debout  
Standing work
- ▶ Roues de transport  
Transportation wheels

Fendeur de bûches - Log splitter	FORCE 11
Gencode	<b>3431541820395</b>
Puissance du moteur - Motor power (230V-50Hz)	<b>3000 W (S6)</b>
Longueur de la bûche - Log length	<b>560 - 1040 mm</b>
Diamètre de la bûche - Log diameter	<b>100 - 300 mm</b>
Force de poussée - Thrust power	<b>11 T / 25,2 Mpa</b>
Vitesse de rotation - Rotation speed	<b>2800 tr/min</b>
Niveau de bruit - Noise level	<b>N.C.</b>
Données logistiques - Logistic informations	



3 431541 820395

Box 660x550x1150 mm | Master 1 x 112,0 kg | Pal 1 pcs | Ctr 20ft 90 pcs

DÉCAPAGE  
STRIPPING

ÉLECTROPORATIF  
HANDPOWER TOOLS

X-FIT  
RANGE

ATELIER  
WORKSHOP

BOIS  
WOOD MACHINES

MÉTAL  
METAL MACHINES

NETTOYAGE  
CLEANING

PARQUETEUR  
PARQUET LAYER

JARDIN  
GARDEN

Plus d'info sur  
**fartools.com**

# Broyeur de végétaux - Schredder - BV 2800

35 mm  
2800 Watts

**VALORISEZ VOS DÉCHETS**  
**IDÉAL PAILLAGE**



Volume de déchet vert  
diminué de 10:1  
10:1 volume decrease of green  
garbage

**NOUVEAU**



Large trémie = grande capacité  
Large hopper = large capacity



Grandes roues de transport  
Large transportation wheels

- ▶ **Idéal pour le paillage et le broyage de gros volumes**  
Ideal for mulching and shredding large volumes
- ▶ **Poignée de transport**  
Carrying handle
- ▶ **Capacité de broyage ø 35 mm MAX**  
Grinding capacity ø 35 mm MAX
- ▶ **Grandes roues de déplacement**  
Large moving wheels
- ▶ **Machine facilement transportable**  
Easily transportable machine
- ▶ **Sac de récupération des broyats 64 litres**  
Wood chips bag 64 liters
- ▶ **machine compacte**  
Compact machine



Broyeur de végétaux grande capacité - Schredder

BV 2800

Gencode **3431541750463**

Puissance du moteur - Motor power (230V-50Hz)

**2800 W**

Diamètre de passage - Through hole diameter

**ø 35 mm**

Vitesse de rotation - Rotation speed

**2800 tr.min<sup>-1</sup>**

Niveau de bruit - Noise level

**94 (+/-3,0)**

Données logistiques - Logistic informations



3 431541 750463

Box 580x460x340 mm | Master 1 x 48,0 kg | Pal 18 pcs | Ctr 20ft 116 pcs

# Broyeur de végétaux - Schredder - BV 2200

70 mm  
2200 Watts

**VALORISEZ VOS  
DÉCHETS  
IDÉAL PAILLAGE**



Volume de déchet vert  
diminué de 10:1  
10:1 volume decrease of green  
garbage

**NOUVEAU**



Large trémie = grande capacité  
Large hopper = large capacity



Interrupteur thermique de sécurité  
Thermal safety switch

- ▶ **Idéal pour le paillage et le broyage de gros volumes**  
Ideal for mulching and shredding large volumes
- ▶ **Poignée de transport**  
Carrying handle
- ▶ **Diamètre de passage de 70 mm MAX**  
Through hole diameter  $\varnothing$  70 mm MAX
- ▶ **Goulotte d'éjection haute**  
High discharge chute
- ▶ **Grandes roues de déplacement**  
Large moving wheels
- ▶ **Machine facilement transportable**  
Easily transportable machine
- ▶ **Interrupteur thermique de sécurité**  
Thermal safety switch
- ▶ **Entrainement par courroie**  
Belt drive motor



**Sécurité**  
Security



Broyeur de végétaux grande capacité - Schredder	<b>BV 2200</b>
Gencode	<b>3431541750476</b>
Puissance du moteur - Motor power (230V-50Hz)	<b>2200 W</b>
Diamètre de passage - Through hole diameter	<b><math>\varnothing</math> 70 mm</b>
Vitesse de rotation - Rotation speed	<b>60 tr.min<sup>-1</sup></b>
Niveau de bruit - Noise level	<b>94 (+/-3,0)</b>
Données logistiques - Logistic informations	



3 431541 750470

Box 580x460x340 mm | Master 1 x 16,0 kg | Pal 18 pcs | Ctr 20ft 350 pcs

DÉCAPAGE  
STRIPPING

ÉLECTROPORATIF  
HANDPOWER TOOLS

X-FIT  
RANGE

ATELIER  
WORKSHOP

BOIS  
WOOD MACHINES

MÉTAL  
METAL MACHINES

NETTOYAGE  
CLEANING

PARQUETEUR  
PARQUET LAYER

JARDIN  
GARDEN

Plus d'info sur  
**far.tools.com**

**Pour la pose sans effort, de tuyaux ou câbles... par lesquels sont distribués fluides et énergie**  
 For effortless laying of pipes or cables... through which fluids and energy are distributed



La trancheuse de sol électrique remplace avantageusement la pioche et la pelle pour réaliser des tranchées sans efforts sur de grandes distances.  
 The electric soil trencher advantageously replaces pickaxe and shovel to make trenches effortless over great distances.



Délimitation de massif

Fil périphérique pour robot tondeuse

Branchements abri de jardin

Alimentation du jardin en eau

Alimentation portail et visiophone

Accès Fibre internet

Sources lumineuses et électriques

Irrigation automatique

Fonction motobineuse

La trancheuse de sol électrique permet la création de tranchées sur une profondeur de 120 mm et une largeur maximale de 60 mm.  
 The electric soil trencher is available for 120 mm trench depth and maximum 60 mm width

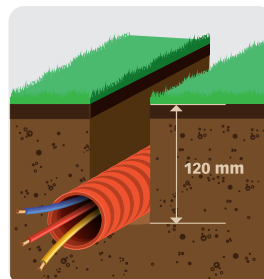



# Trancheuse électrique - Power Trencher - TM 1500

1500 W



Fini le travail difficile à la pelle bêche  
Easier than with shovel



x 2

YouTube



Trancheuse : Enfouissement  
Trencher: landfill



120 mm



Motobineuse : Travail du jardin  
Tiller: Garden work

- ▶ **Idéale pour l'enfouissement des fils périphériques pour robot tondeuse**  
Ideal for burying peripheral wires for robot mowers
- ▶ Livrée avec 2 fraises à deux lames, pour transformer la trancheuse en motobineuse  
Supplied with 2 cutters with two blades, to transform the Trencher into a tiller
- ▶ Profondeur de tranchée = 120 mm  
Trench depth = 120 mm
- ▶ Largeur de tranchée = 60 mm MAXI  
Trench width = 60 mm MAX

Livré pré-monté  
Delivered fully assembled



Trancheuse électrique - Power trencher

TM 1500

Gencode 3431541753150

Puissance du moteur - Motor power (230V~50Hz)

1500 W

Vitesse de rotation - Rotation speed

260-340 min-1

Profondeur de travail - Working depth

120 mm

Largeur de travail - Working width

60 mm

Données logistiques - Logistic informations



3 431541 753150

Box 850x400x380 mm | Master 1 x 13,75 kg | Pal 12 pcs | Ctr 20ft 217 pcs

DÉCAPAGE  
STRIPPING

ÉLECTROPORATIF  
HANDPOWER TOOLS

X-FIT  
RANGE

ATELIER  
WORKSHOP

BOIS  
WOOD MACHINES

MÉTAL  
METAL MACHINES

NETTOYAGE  
CLEANING

PARQUETEUR  
PARQUET LAYER

JARDIN  
GARDEN

Plus d'info sur  
fartools.com

1200 W  
560 mm

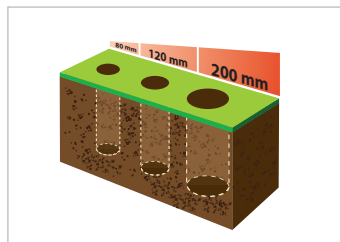

3 diamètres possibles  
3 possible diameters

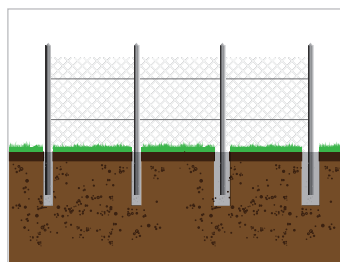

Pose de poteaux de clôture  
Laying fence posts

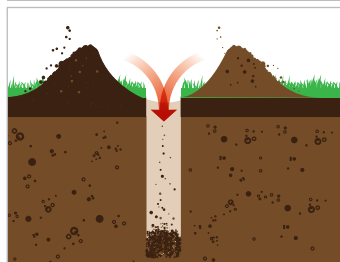

Malaxage terre-terreau  
Earth-soil mixing

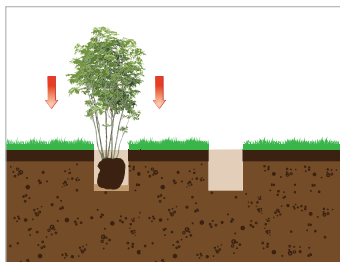

Plantation directe d'arbuste  
Direct planting shrub

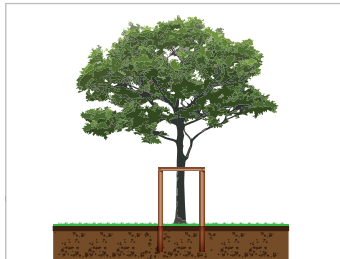

Tuteurage  
Staking



LE PODIUM  
THE PODIUM



OFFERT selon quantités  
FREE according to quantities

- ▶ **Inverseur de sens**  
Direction reverser
- ▶ **Plus de soucis liés aux moteurs thermiques :**  
Démarrage, hivernage, carburant, vidange, nuisances sonores...
- ▶ **Débrayage automatique**  
Automatic release
- ▶ **Diamètres de vis possibles = 80-200 mm (option)**  
Optional auger diameters = 80-200 mm (optional)

Livré pré-monté avec vis ø 120 mm  
Delivered fully assembled with screw ø 120 mm



YouTube



Tarière électrique - Power auger	TE 1200B
Gencode	3431541753051
Puissance du moteur - Motor power (230V-50Hz)	1200 W
Vitesse de rotation - Rotation speed	200 min-1
Profondeur de travail - Working depth	560 mm
Largeur de travail - Working width	120 mm   4,7"
Données logistiques - Logistic informations	
Box 850x400x380 mm   Master 1 x 13,75 kg   Pal 12 pcs   Ctr 20ft 217 pcs	
Vis ø 80 mm (3,15") - Auger	3431541753068
Vis ø 200 mm (7,8") - Auger	3431541753075

# Aspirateur / souffleur de feuilles - Leaf vacuum / blower - AB 2600B

2800 W  
16 m<sup>3</sup>/min



Râteau frontal  
Front rake



- ▶ **Râteau frontal ajustable pour feuilles mouillées**  
Adjustable front rake for wet leaves
- ▶ **2 Fonctions: Souffleur et Aspirateur / Broyeur**  
2 functions: Blower and Vacuum / Crusher
- ▶ **Roulettes frontales**  
Front wheels
- ▶ **Format compact pour rangement facile**  
Compact shape for an easy storage
- ▶ **Turbine de forte puissance**  
High power turbine
- ▶ **Vitesse variable pour s'adapter au support**  
Electronic variable speed
- ▶ **Hauteur ajustable**  
Adjustable tube
- ▶ **Trappe de débouillage sécurisée et râteau frontal en métal**  
Secure stripping trap and front metal rake

*Livré avec sac toile 45 Litres à démontage rapide et sangle*  
*Delivered with 45 L bag with easy removable function and strap*

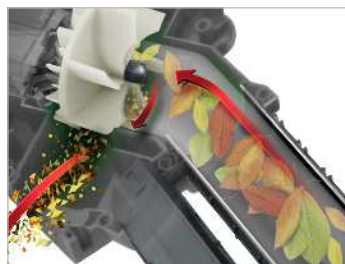

Fonction aspirateur / broyeur  
Vacuum / Crusher function

Aspirateur / souffleur de feuilles - Leaf vacuum / blower		AB 2600B
Gencode		<b>3431541750432</b>
Puissance du moteur - Motor power (230V-50Hz)		<b>2800 W</b>
Variateur de vitesse électronique - Electronic variable speed		<b>10000-16500.min<sup>-1</sup></b>
Volume du sac de récupération - Volume of Recovery Bag		<b>45 L</b>
Fonction aspirateur - Vacuum function		<b>16 m<sup>3</sup>.min<sup>-1</sup></b>
Fonction souffleur - Blowing function		<b>100-300 km/h</b>
Niveau de bruit - Noise level		<b>91-102 (+/-3,0)</b>
<b>Données logistiques - Logistic informations</b>		



3 431541 750432

Box 920x210x305 mm | Master 1 x 5,0 kg | Pal 20 pcs | Ctr 20ft 520 pcs

DÉCAPAGE  
STRIPPING

ÉLECTROPORATIF  
HANDPOWER TOOLS

X-FIT  
RANGE

ATELIER  
WORKSHOP

BOIS  
WOOD MACHINES

MÉTAL  
METAL MACHINES

NETTOYAGE  
CLEANING

PARQUETEUR  
PARQUET LAYER

JARDIN  
GARDEN

Plus d'info sur  
**far.tools.com**

# Désherbeur électrique - Electric weeder - DT 2000B

2000 W  
600 ° C

LE BOX  
THE BOX



OFFERT selon quantités  
FREE according to quantities



- ▶ **Ecologique, produit respectueux de l'environnement :**  
sans gaz = pas de produit chimique  
sans flamme = aucun rejet de CO2  
Ecological, environmentally friendly:  
no gas = no chemical product  
no flame = no releases of CO2
- ▶ **Economique (10 x moins cher que le gaz)**  
Economic (10 x cheaper than gas)
- ▶ **Poignée ergonomique**  
Ergonomic handle
- ▶ **Cartier de protection anti-brûlures**  
Safety anti-scald guard
- ▶ **Fonction décapeur thermique**  
Thermal cleaner function

Désherbeur électrique - Electric weeder	DT 2000B
Gencode	3431541750500
Puissance du moteur - Motor power (230V~50Hz)	2000 W
Allure de chauffe - Heat settings	x 2 : 50 / 600° C

Données logistiques - Logistic informations



3 431541 750500 | Box 480x290x420 mm | Master 10 x 1,20 kg | Pal 240 pcs | Ctr 20ft 5000 pcs

# Outil multifonctions 4 en 1 - Multipurpose 4 in 1 machine - OMF 900

900 W



**1**  
Tronçonneuse  
Chainsaw



Fonction élagueuse  
Pole pruner function



Fonction taille haies orientable  
Orientable hedge trimmer



Fonction coupe bordure  
Grass trimmer function



Fonction débroussailluse  
Brush cutter function

**2**  
Taille haies  
Hedge trimmer

**3**  
Coupe bordures  
Grass trimmer

**4**  
Débroussailluse  
Brush cutter

- ▶ Une machine pour 4 fonctions :  
Tronçonneuse, taille haies, coupe bordure et débroussailluse.  
One machine for 4 functions : chainsaw, hedge trimmer, grass trimmer and brush cutter
- ▶ Taille haies orientable de -45° à 90°  
- 45° to 90° adjustable head
- ▶ Tronçonneuse avec graissage automatique  
Chainsaw with automatic greasing
- ▶ Coupe bordure avec sortie du fil par pression au sol  
Output of the wire by push on the floor



**Emboîtable**  
Nestable



**AUTO**



**4 en 1**

Outil multifonctions 4 en 1 - Multipurpose 4 in 1 machine		OMF 900
Gencode	<b>3431541750449</b>	
Puissance du moteur - Motor power (230V~50HZ)	<b>900 W</b>	
Vitesse de rotation - Rotation speed	<b>7200 tr/min   6,5 m.s<sup>-1</sup></b>	
Dimension de la lame - Blade size	<b>250 mm   10"</b>	
Longueur de coupe - Cutting length	<b>430 mm   17"</b>	
Course des couteaux - Knives travel	<b>20 mm</b>	
Diamètre de coupe - Cutting diameter	<b>ø 360 mm   ø 14"</b>	
Diamètre du fil - Cutting diameter	<b>ø 1,6 mm</b>	
Diamètre de coupe - Cutting diameter	<b>ø 230 mm   ø 9"</b>	
Données logistiques - Logistic informations		
Box 940x140x255 mm   Master 2 x 9,45 kg   Pal 24 pcs   Ctr 20ft 864 pcs		
Consommables - Consumables		
Chaîne - Chain	<b>3431541758186</b>	
Bobine de fil ø 1,6 mm - Wire reel ø 1,6 mm	<b>3431541758193</b>	



DÉCAPAGE  
STRIPPING

ÉLECTROPORATIF  
HANDPOWER TOOLS

X-FIT  
RANGE

ATELIER  
WORKSHOP

BOIS  
WOOD MACHINES

MÉTAL  
METAL MACHINES

NETTOYAGE  
CLEANING

PARQUETEUR  
PARQUET LAYER

JARDIN  
GARDEN

Plus d'infos sur  
**fartools.com**

Metal cut-off Saw - TD 1500

Ø 180 mm  
1500 Watts

Special **EXPORT**

**NEW**



Angle cut

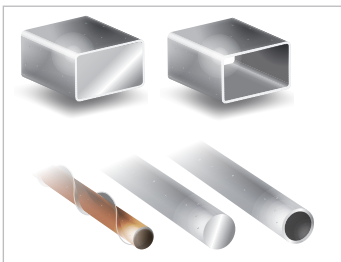

Allows cutting all types of metals

- ▶ Head lock in low position for safety transportation
- ▶ **ULTRA COMPACT Ø 180 mm**
- ▶ Safety glasses holder
- ▶ Ergonomic control handle
- ▶ Quick vice
- ▶ Transportation handle
- ▶ Mute seller

Delivered with 1 mounted abrasive disc

7" Metal cut-off saw	TD 1500
Gencode	<b>3431541155060</b>
Motor power (230V~50Hz)	<b>1500 W</b>
Blade diameter / bore	<b>Ø 180 / 22,2 mm</b>
Rotation speed	<b>8000 tr.min<sup>-1</sup></b>
Cutting capacities (90°)	<b>45 x 45 mm 30 x 90 mm Ø 50 mm</b>
Cutting capacities (45°)	<b>45 x 45 mm 32 x 32 mm Ø 32 mm</b>
<i>Logistic informations</i>	
Box 394x270x305 mm   Master 1 x 7,8 kg   Pal 36 pcs   Ctr 20ft 960 pcs	
<i>Consumables</i>	
5 Flat cutting disc set	<b>3431541190948</b>



**120 x 100 mm**  
900 Watts

Special **EXPORT**



**NEW**



- ▶ Asynchronous motor 900 W
- ▶ Stationary work for more accuracy
- ▶ Adjustable tool support
- ▶ Opening covers for quick brush change
- ▶ Y shaped suction outlet for vacuum cleaner

*Delivered with brass coated steel and flap brush A40 brushes*



Stationary renovator	<b>REX 120 - BENCH</b>
Gencode	<b>3431541150539</b>
Motor power (230V-50Hz)	<b>900 W</b>
Rotation speed	<b>2980 min<sup>-1</sup></b>
Brush sizes	<b>120 x 100 mm Max</b>
<i>Logistic informations</i>	
 Box 720x285x258 mm   Master 1 x 22,0 kg   Pal 72   Ctr 20ft 1800 pcs	
<i>Consumables</i>	
See next page 13	

# Wood & metal Band saw - RBS 710

1712 mm  
710 Watts

Special **EXPORT**

**NEW**



Perfect wood cuts



Incredible metal cutting capacities



Usefull for wood with metal inside

- ▶ Bi metal M42 blade for Wood & metal cuts
- ▶ Tilt table
- ▶ Dust suction nozzle
- ▶ Swan neck 200 mm

*Delivered with parallel guide and pushing bar*

8" Wood & metal band saw	RBS 710
Gencode	<b>3431541132931</b>
Motor power (230V~50Hz)	<b>710 W</b>
Blade sizes	<b>1400x13x0,68 mm</b>
Teeth number	<b>8/12 TPI</b>
Rotation speeds	<b>6,6 / 18,3 m.s<sup>-1</sup></b>
Maximum cutting capacities	<b>80 x 200 mm</b>
Tilting table	<b>0 - 45°</b>
Table sizes	<b>300 x 300 mm</b>

*Logistic informations*

3 431541 132931 | Box 880x440x340 mm | Master 1 x 30,0 kg | Pal 6 pcs | Ctr 20ft 192 pcs

*Consumables*

Wood & metal blade	<b>3431541137974</b>
--------------------	----------------------



**100x915 mm / ø 150 mm**

550 Watts

*Special* **EXPORT**

**NEW**



Cylinder sander function

► **3 Functions: Sander + Linisher + Tube sander**

- Handle for easier transport
- Tilting table
- Dust recovery outlet

*Delivered with one abrasive belt GR 120 and one abrasive disc GR 80*

Sander linisher and tube sander	<b>SLTS 550</b>
Gencode	<b>3431541132061</b>
Motor power (230V~50Hz)	<b>550 W</b>
Belt sizes	<b>50 x 1050 mm GR120</b>
Disc diameter	<b>ø 150 mm / GR80</b>
Rotation speed	<b>2980 tr.min<sup>-1</sup> 11,6 m.s<sup>-1</sup></b>
Tilting table	<b>0 - 45°</b>

*Logistic informations*

3 431541 1132061 Box 308x460x518 mm | Master 1 x 16,50 kg | Pal 24 pcs | Ctr 20ft 520 pcs

*Consommables - Consumables*

6 Discs A120/A80/A40	<b>3431541132597</b>
2 Belts A120	<b>3431541132672</b>

**NEW**



# MPO Distribuce s.r.o.

Distributor pro ČR a SR

MPO Distribuce s.r.o.

Jaurisova 515/4 14000 Praha 4

[www.kartacove-brusky.cz](http://www.kartacove-brusky.cz)

tel: +420 212 242 399

[www.dodavatel-naradi.cz](http://www.dodavatel-naradi.cz)



**Wolfcraft**

[www.wolfcraftcz.cz](http://www.wolfcraftcz.cz)



**Fartools**

[www.kartacove-brusky.cz](http://www.kartacove-brusky.cz)

**ULTRA  
GRIME**

**Ultragrime**

[www.ultragrime.cz](http://www.ultragrime.cz)

**STEHOVACI-PASY.CZ**  
MAKES LIFTING EASIER

**Shoulder Dolly**

[www.shoulderdolly.cz](http://www.shoulderdolly.cz)



**Bruns**

[www.drzakynaradi.cz](http://www.drzakynaradi.cz)



**Peugeot**

[www.naradi-kvalitne.cz](http://www.naradi-kvalitne.cz)